





# LEAVES

design ridea

~~~~~

Una foglia dalla forma sinuosa e sottile, un poco ripiegata, dai contorni plastici e dall'effetto superficiale magmatico e metallico, per partire con l'immaginazione, per dimenticare lo stress e il brutto della vita, per godere solo il meglio dei vostri sensi: coccolati dal calore e dal piacere estetico guardare e toccare una scultura contemporanea.





~~~~~

A sinuous thin bended leaf, with smooth profiles and metallic surface, in which reflex you can imagine forget any stress or life troubles, in order to listen just your feelings: cuddled by the warm and the pleasure in looking and touching such a wonderful contemporary sculpture.

*Finitura fotografata in queste pagine:  
alluminio "sfumato".*

*Finish photographed on these pages:  
"faded" aluminium.*

# LEAVES

hxb (cm)	n numero elementi/ elements number	peso a vuoto / weight empty (kg)	volume d'acqua / water volume (dm <sup>3</sup> )	a (cm)	c (cm)	d (cm)	e (cm)	Qs resa termica / thermal yield □t 50°C (watt)	Q potenza elettrica / electrical power (watt)	versione mista** / combined version**	fissa / not opening	fissa*** / not opening***
												
<b>verticale/vertical</b>												
180,0x50,0	1	17,0	0,32	134,0	6,5	34,0	25,0	818	810	•	•	-
200,0x60,0	1	22,0	0,42	155,0	8,0	45,0	30,0	1043	1020	•	•	-
<b>orizzontale/horizontal</b>												
50,0x180,0	1	17,0	0,32	134,0	6,5	34,0	25,0	818	810	•	-	•
60,0x200,0	1	22,0	0,42	155,0	8,0	45,0	30,0	1043	1020	•	-	•

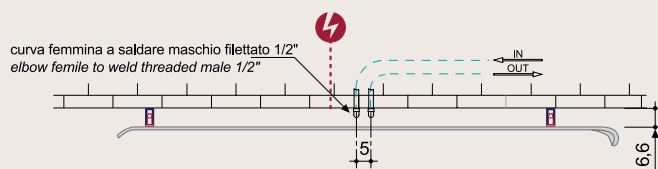
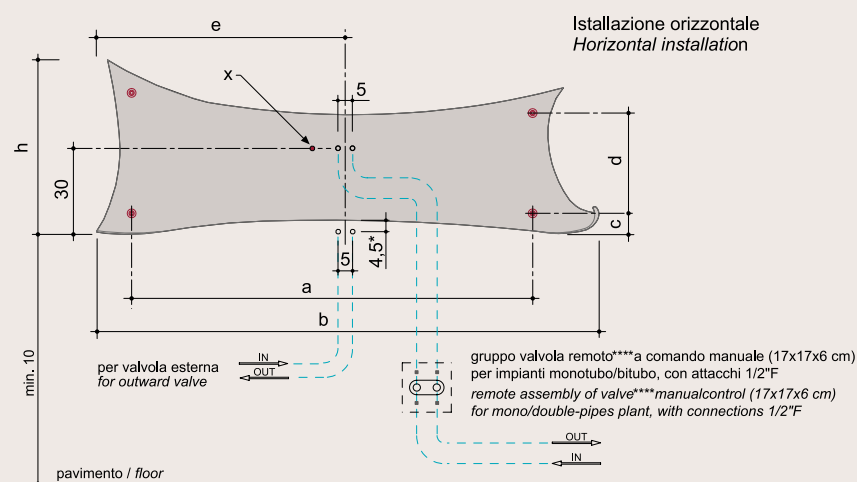
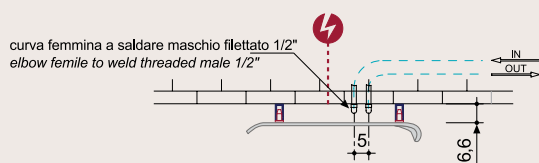
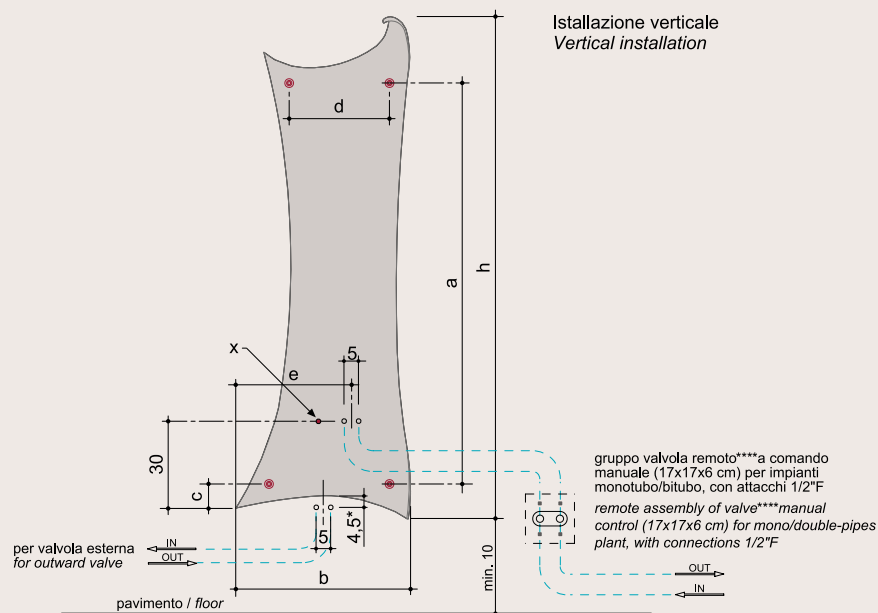

\*.  
utilizzando valvole Ridea  
\*\*.  
a richiesta con sovrapprezzo  
\*\*\*.  
a richiesta senza sovrapprezzo  
\*\*\*\*.  
la valvola a incasso può essere  
posizionata anche distante dal  
radiatore; l'importante è che sia  
posizionata più bassa rispetto  
all'entrata dell'acqua nel  
radiatore. I 4 raccordi 1/2" M per  
i tubi di collegamento non sono  
forniti di serie.  
X.  
posizione ingresso a muro del  
cavo (per versione elettrica  
e mista)

\*.  
using Ridea valves  
\*\*.  
upon request with surcharge  
\*\*\*.  
upon request without surcharge  
\*\*\*\*.  
built-in valve can also be placed  
away from the radiator; the  
important thing is that it is  
positioned lower than the entry  
of water into the radiator. The 4  
fitting 1/2" M for the connecting  
pipes are not supplied as  
standard.  
X.  
electrical wire wall entry  
position (for electric and  
mixed version)