

eco **GENUS**

Condensing

**Installation
Instructions**

Type C Boilers

G.C.N: 41-116-03

47-116-17

**LEAVE THESE INSTRUCTIONS
WITH THE END-USER**



*The code of practice for the installation,
commissioning & servicing of central heating systems*



ARISTON

Country of destination: GB

TABLE OF CONTENTS

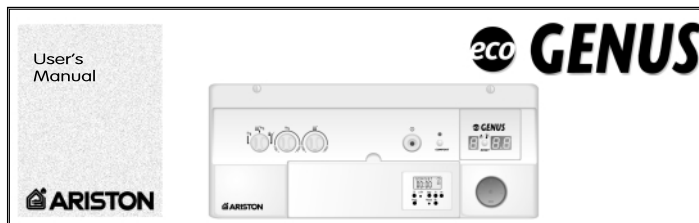
1.	GENERAL INFORMATION
1.1.	GENERAL INFORMATION
1.3.	OVERALL VIEW
2.	INSTALLATION
2.1.	REFERENCE STANDARDS
2.2.	SITING THE APPLIANCE
2.3.	OVERALL DIMENSIONS
2.4.	MINIMUM CLEARANCES
2.5.	MOUNTING THE APPLIANCE
2.6.	ELECTRICAL CONNECTION
2.7.	GAS CONNECTION
2.8.	WATER CONNECTIONS
2.9.	FLUE CONNECTIONS
2.10.	ACCESSORY CONNECTION
2.10.1.	ROOM THERMOSTAT CONNECTION
2.10.2.	REMOTE CONTROL CONNECTION
2.10.3.	ACCESSORY CONNECTION TERMINAL BLOCK
2.10.4.	CYLINDER TEMPERATURE PROBE CONNECTION
2.10.5.	REMOTE CONTROL TERMINAL BLOCK AND CYLINDER PROBE
2.11.	ELECTRICAL DIAGRAM
2.12.	WATER CIRCUIT DIAGRAMS
3.	COMMISSIONING
3.1.	INITIAL PROCEDURES
3.2.	REMOVING THE CASING
3.3.	CONTROL PANEL
3.4.	INITIAL START-UP
3.5.	DISPLAY: MESSAGES SHOWN DURING NORMAL OPERATION
3.6.	OPERATING PARAMETERS
3.6.1.	CONTROL MODES
3.6.2.	OUTDOOR SENSOR
3.6.3.	SETTINGS DISPLAY
3.7.	REGULATIONS
3.7.1.	POTENTIOMETER
3.7.2.	SETTING THE TEMPERATURE FIELD
3.7.3.	COMFORT KEY/HEATING ONLY
3.7.4.	POST-CIRCULATION OF THE PUMP
3.7.5.	TEST MODE
3.7.6.	REGULATION MENU TABLE
3.8.	BOILER SAFETY SYSTEMS
3.9.	COMBUSTION ANALYSIS
3.10.	DRAINING
4.	GAS ADJUSTMENTS
4.1.	OVERALL VIEW
4.2.	PRELIMINARIES
4.3.	GAS REGULATION
4.3.1.	TEST OF THE CONNECTION PRESSURE
4.3.2.	REGULATION OF THE THERMAL POWER
4.4.	CHANGING THE TYPE OF GAS
4.5.	OPERATING TESTS
5.	ZONE VALVES
6.	MAINTENANCE
6.1.	GENERAL REMARKS
6.2.	CLEANING THE PRIMARY EXCHANGER
6.3.	CLEANING THE CONDENSATE TRAP
6.4.	OPERATIONAL TEST
7.	TECHNICAL INFORMATION

1. GENERAL INFORMATION

This manual is an integral and essential part of the product. It should be kept with the appliance so that it can be consulted by the user and our authorised personnel.

Please carefully read the instructions and notices about the unit contained in this manual, as they provide important information regarding the safe installation, use and maintenance of the product.

For operating instructions please consult the separate User's Manual.



1.1. GENERAL INFORMATION

Read the instructions and recommendations in these Installation Instructions carefully to ensure proper installation, use and maintenance of the appliance.

Keep this manual in a safe place. You may need it for your own reference while our Servicing Centre technicians or your installer may need to consult it in the future.

This is a combined appliance for the production of central heating (C.H.) and domestic hot water (D.H.W.).

This appliance **must be used only** for the purpose for which it is designed.

The manufacturer declines all liability for damage caused by improper or negligent use.

No asbestos or other hazardous materials have been used in the fabrication of this product.

Before connecting the appliance, check that the information shown on the data plate and the table on pages 4-5 comply with the electric, water and gas mains of the property. You will find the data plate on the reverse of the control panel.

The gas with which this appliance operates is also shown on the label at the bottom of the boiler.

Do not install this appliance in a damp environment or close to equipment which spray water or other liquids.

Do not place objects on the appliance.

Do not allow children or inexperienced persons to use the appliance without supervision.

If you smell gas in the room, **do not turn on** light switches, use the telephone or any other object which might cause sparks.

Open doors and windows immediately to ventilate the room.

Shut the gas mains tap (on the gas meter) or the valve of the gas cylinder and call your Gas Supplier immediately.

If you are going away for a long period of time, remember to shut the mains gas tap or the gas cylinder valve.

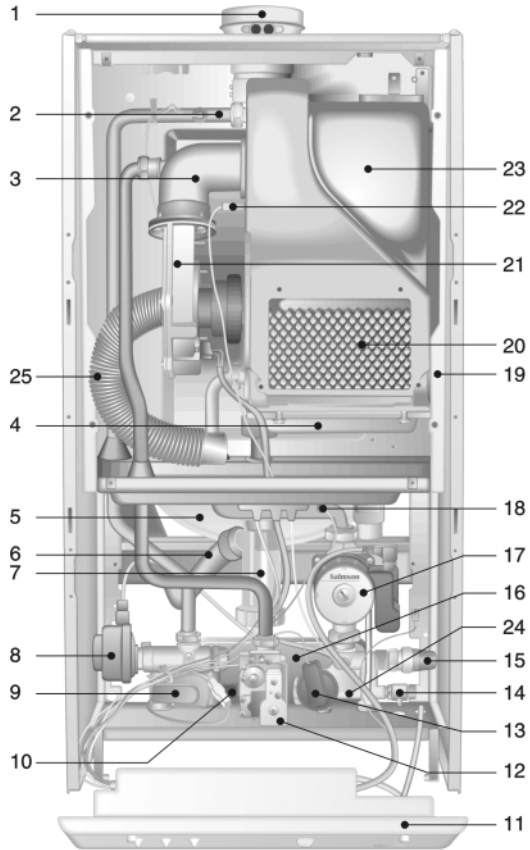
Always disconnect the appliance either by unplugging it from the mains or turning off the mains switch before cleaning the appliance or carrying out maintenance.

In the case of faults or failure, switch off the appliance and turn off the gas tap. Do not tamper with the appliance.

For repairs, call your local Authorised Servicing Centre and request the use of original spare parts. For in-guarantee repairs contact MTS (GB) Limited

1.3. OVERALL VIEW

eco GENUS 24 MFFI



LEGEND:

1. Flue connector
2. Heating flow temperature probe
3. Mixer
4. Condensate collector
5. Expansion vessel
6. Condensate trap (tube)
7. Condensate trap
8. Diverter valve
9. Main circuit flow switch
10. Domestic hot water temperature probe
11. Control panel
12. Gas valve
13. Domestic hot water flow switch
14. Drain valve
15. Safety valve (3 bar)
16. Secondary heat exchanger
17. Circulation pump with automatic air release valve
18. Heating return temperature probe
19. Sealed combustion chamber
20. Combustion chamber inspection hatch
21. Fan
22. Ignition and detection electrode
23. Main heat exchanger (aluminium)
24. Automatic by-pass
25. Silencer

2. INSTALLATION

The technical information and instructions provided herein below are intended for the installer so that the unit may be installed correctly and safely.

2.1. REFERENCE STANDARDS

The installation and initial start-up of the boiler must be by a CORGI Approved Installer in compliance with the installation standards currently in effect, as well as with any and all local health and safety standards i.e. CORGI.

This appliance must be installed by a competent installer in accordance with the current Gas Safety (installation & use) Regulations.

The installation of this appliance must be in accordance with the relevant requirements of the current Gas Safety (installation & use) Regulations, the Local Building Regulations, the current I.E.E. Wiring Regulations, the byelaws of the local water authority, and in Scotland, in accordance with the Building Standards (Scotland) Regulation and Health and Safety document No. 635 "Electricity at work regs. 1989". Installation should also comply with the following British Standard Codes of Practice:

Low pressure pipes	BS 6891	1988
Boilers of rated input not exceeding 60 kW	BS 6798	1987
Forced circulation hot water system	BS 5449	1990
Installation of gas hot water supplies for domestic purposes (2 nd family gases)	BS 5546	1990
Flues	BS 5440-1	1990
Air supply	BS 5440-2	1989

eco GENUS 24 RFFI SYSTEM

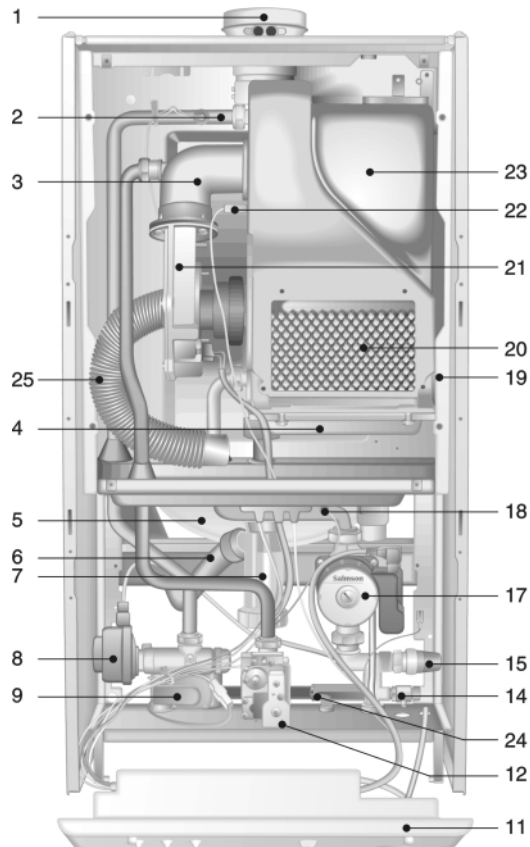


FIG. 1.1

2.2. SITING THE APPLIANCE

The appliance may be installed in any room or indoor area, although particular attention is drawn to the requirements of the current I.E.E. Wiring Regulations, and in Scotland, the electrical provisions of the Building Regulations applicable in Scotland, with respect to the installation of the combined appliance in a room containing a bath or shower.

Where a room-sealed appliance is installed in a room containing a bath or shower the boiler and any electrical switch or appliance control, utilising mains electricity should be situated so that it cannot be touched by a person using the bath or shower.

The location must permit adequate space for servicing and air circulation around the appliance as indicated in paragraph 2.4.

The location must permit the provision of an adequate flue and termination.

For unusual locations special procedures may be necessary.

BS 6798-1987 gives detailed guidance on this aspect.

A compartment used to enclose the appliance must be designed specifically for this purpose. No specific ventilation requirements are needed for an installation within a cupboard.

This appliance is not suitable for outdoor installation.

The type C appliances (in which the combustion circuit, air vent intake and combustion chamber are air-tight with respect to the room in which the appliance is installed) can be installed in any type of room.

There are no limitations with respect to ventilation and the volume of the room itself. The boiler must be installed on a solid, permanent wall to prevent access to the electrical parts (when live) through the aperture on the back frame.

2.3. OVERALL DIMENSIONS

LEGEND:

A = Central Heating Flow (3/4")

B = Domestic Hot Water Outlet (1/2")

C = Gas Inlet (3/4")

D = Domestic Cold Water Inlet (1/2")

E = Central Heating Return (3/4")

F = Cylinder Flow (3/4")

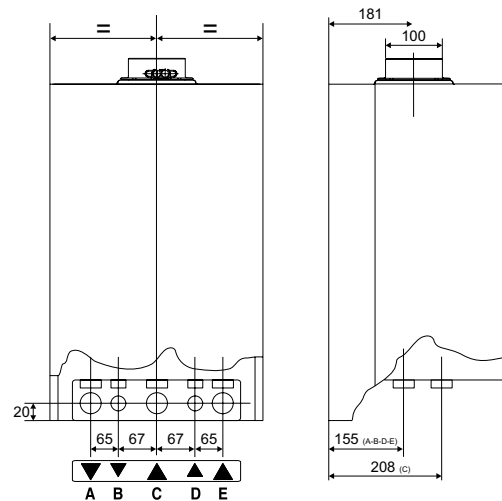
G = Cylinder Return (3/4")

H = Condensate discharge

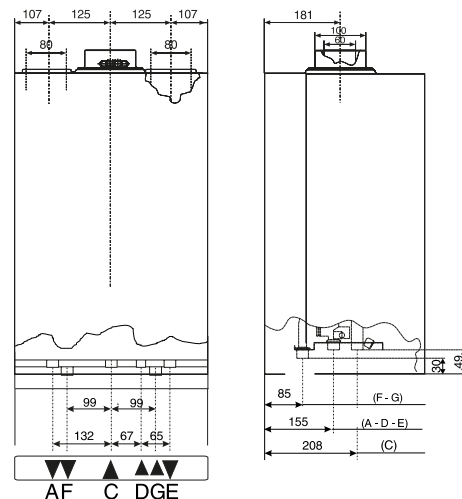


FIG. 2.1

GENUS 24 MFFI



GENUS 24 RFFI SYSTEM

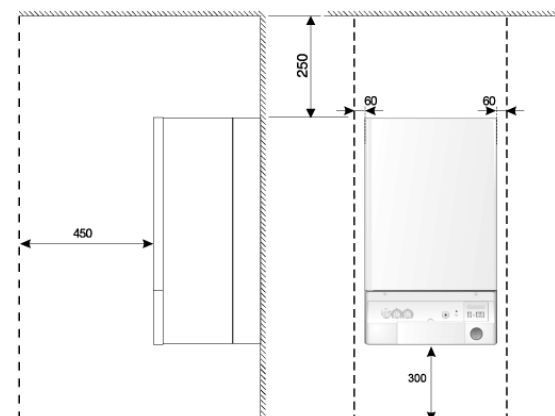


2.4. MINIMUM CLEARANCES

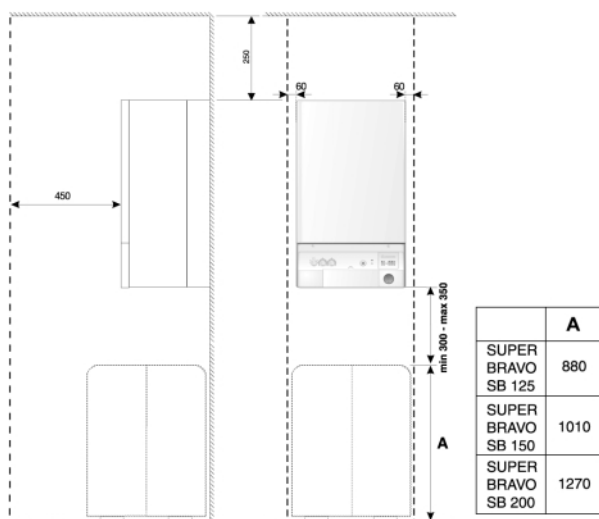
In order to allow for access to the interior of the boiler for maintenance purposes, the boiler must be installed in compliance with the clearance requirements indicated in the diagram below.

eco GENUS 24 MFFI

FIG. 2.2



eco GENUS 24 MFFI SYSTEM



2.5. MOUNTING THE APPLIANCE

Fasten the boiler in place using the template and anchors supplied with the unit. It is highly recommended that a spirit level be used to position the boiler so that it is perfectly level.

For additional information, please consult the instructions contained in the connection kit and the flue kit.

2.6. ELECTRICAL CONNECTION

For safety purposes, have a competent person carefully check the electrical system in the property, as the manufacturer will not be held liable for damage caused by the failure to earth the appliance properly or by anomalies in the supply of power. Make sure that the residential electrical system is adequate for the maximum power absorbed by the unit, which is indicated on the rating plate. In addition, check that the section of cabling is appropriate for the power absorbed by the boiler.

The boiler operates with alternating current, as indicated in the technical data table (1.2), where the maximum absorbed power is also indicated. Make sure that the connections for the neutral and live wires correspond to the indications in the diagram. The appliance electrical connections are situated on the reverse of the control panel (see the servicing manual for further information)

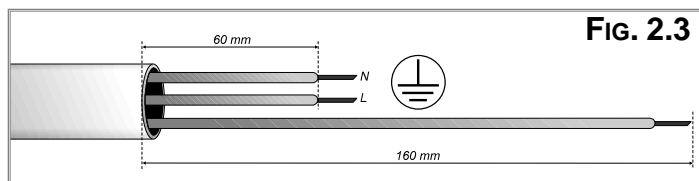


FIG. 2.3

IMPORTANT!

In the event that the power supply cable must be changed, replace it with one with the same specifications. Make the connections to the terminal board located within the control panel, as follows:

- The yellow-green wire should be connected to the terminal marked with the earth symbol; make sure to re-use the ferrule mounted on the other supply cord;
- The blue wire should be connected to the terminal marked "N";
- The brown wire should be connected to the terminal marked "L".

Note: The diagrams for the electrical system are indicated in section 2.11.

Warning, this appliance must be earthed.

External wiring to the appliance must be carried out by a qualified technician and be in accordance with the current I.E.E. Regulations and applicable local regulations. The Genus range of boilers are supplied for connection to a 230 V~ 50 Hz supply.

The supply must be fused at 3 A.

The method of connection to the electricity supply must facilitate complete electrical isolation of the appliance, by the use of a fused double pole isolator having a contact separation of at least 3 mm in all poles or alternatively, by means of a 3 A fused three pin plug and unswitched shuttered socket outlet both complying with BS 1363.

The point of connection to the Electricity supply must be readily accessible and adjacent to the appliance unless the appliance is installed in a bathroom when this must be sited outside the bathroom.

2.7. GAS CONNECTION

The local gas region contractor connects the gas meter to the service pipe.

If the gas supply for the boiler serves other appliances ensure that an adequate supply is available both to the boiler and the other appliances when they are in use at the same time.

Pipe work must be of an adequate size. Pipes of a smaller size than the boiler inlet connection should not be used.

2.8. WATER CONNECTIONS

VIEW OF THE BOILER CONNECTIONS

GENUS 24 MFFI

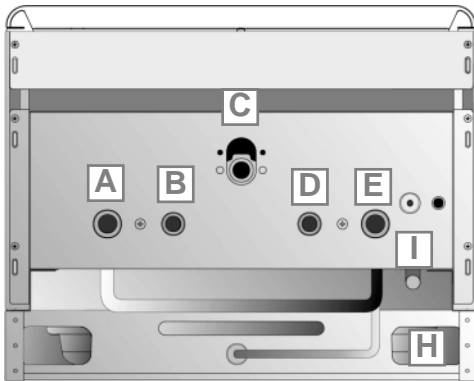
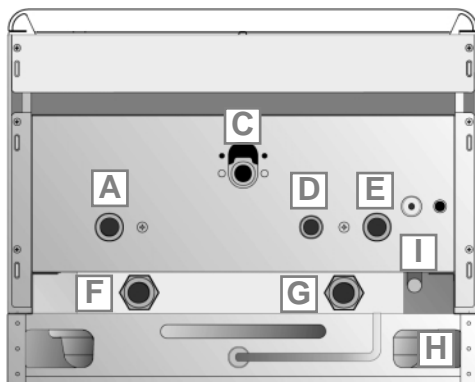


FIG. 2.4

GENUS 24 MFFI SYSTEM



LEGEND:

- A = Central Heating Flow
- B = Domestic Hot Water Outlet
- C = Gas Inlet
- D = Domestic Cold Water Inlet
- E = Central Heating Return
- F = Cylinder Flow
- G = Cylinder Return
- H = Condensate discharge
- I = Safety valve discharge

CENTRAL HEATING

Detailed recommendations are given in BS 6798:1987 and BS 5449-1:1990, the following notes are given for general guidance.

PIPE WORK:

Copper tubing to BS EN 1057:1996 is recommended for water pipes. Jointing should be either with capillary soldered or compression fittings.

Where possible pipes should have a gradient to ensure air is carried naturally to air release points and water flows naturally to drain taps.

The appliance has a built-in automatic air release valve, however it should be ensured as far as possible that the appliance heat exchanger is not a natural collecting point for air.

Except where providing useful heat, pipes should be insulated to prevent heat loss and avoid freezing.

Particular attention should be paid to pipes passing through ventilated spaces in roofs and under floors.

BY-PASS:

The appliance includes an automatic by-pass valve, which protects the main heat exchanger in case of reduced or interrupted water circulation through the heating system, due to the closing of thermostatic valves or cock-type valves within the system.

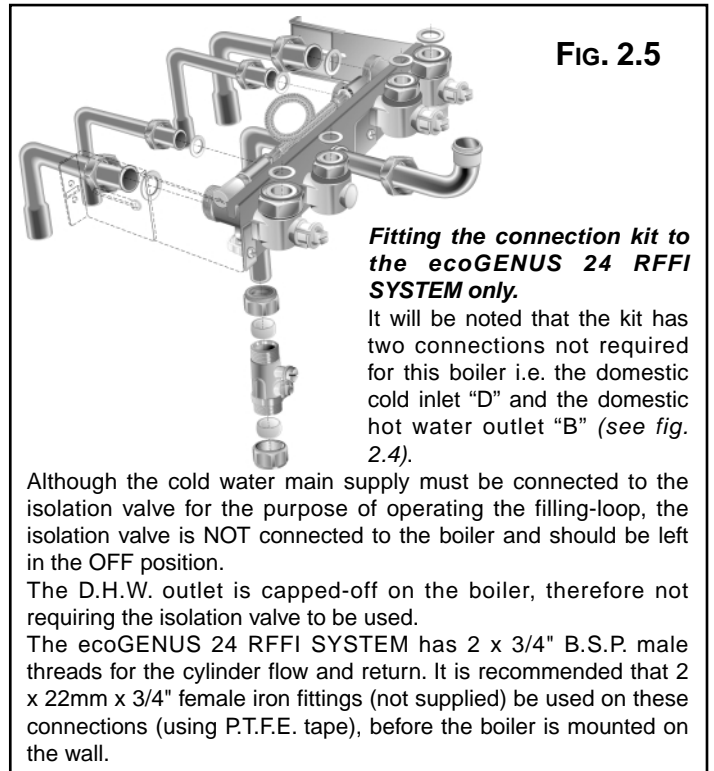


FIG. 2.5

Fitting the connection kit to the ecoGENUS 24 RFFI SYSTEM only.

It will be noted that the kit has two connections not required for this boiler i.e. the domestic cold inlet "D" and the domestic hot water outlet "B" (see fig. 2.4).

Although the cold water main supply must be connected to the isolation valve for the purpose of operating the filling-loop, the isolation valve is NOT connected to the boiler and should be left in the OFF position.

The D.H.W. outlet is capped-off on the boiler, therefore not requiring the isolation valve to be used.

The ecoGENUS 24 RFFI SYSTEM has 2 x 3/4" B.S.P. male threads for the cylinder flow and return. It is recommended that 2 x 22mm x 3/4" female iron fittings (not supplied) be used on these connections (using P.T.F.E. tape), before the boiler is mounted on the wall.

SYSTEM DESIGN:

This boiler is suitable only for sealed systems.

DRAIN COCKS:

These must be located in accessible positions to permit the draining of the whole system. The taps must be at least 15mm nominal size and manufactured in accordance with BS 2870:1980.

SAFETY VALVE DISCHARGE:

The discharge should terminate facing downwards on the exterior of the building in a position where discharging (possibly boiling water & steam) will not create danger or nuisance, but in an easily visible position, and not cause damage to electrical components and wiring.

The discharge must not be over an entrance or a window or any other type of public access.

CONDENSATE DISCHARGE:

The condensate discharge hose from the boiler must be inserted by at least 50 mm into a suitable acid resistant pipe - e.g. plastic waste or overflow pipe. The condensate discharge pipe must have a continuous fall and preferably be installed and terminated within the building to prevent freezing.

The discharge pipe must be terminated in a suitable position:

- i) Connecting in to an internal soil stack (at least 450 mm above the invert of the stack). A trap giving a water seal of at least 75 mm must be incorporated into the pipe run, there also must be an air break upstream of the trap.
- ii) Connecting into the waste system of the building such as a washing machine or sink. The connection must be upstream of the washing machine/sink (If the connection is down stream of the waste trap then an additional trap giving a minimum water seal of 75 mm and an air break must be incorporated in the pipe run, as above.
- iii) Terminating into a gully, below the grid level but above the water level.
- iv) Into a soakway.

NOTE: If any condensate pipe work is to be installed externally, then it should be kept to a minimum and be insulated with a waterproof insulation and have a continuous fall.

AIR RELEASE POINTS:

These must be fitted at all high points where air naturally collects and must be sited to facilitate complete filling of the system.

The appliance has an integral sealed expansion vessel to accommodate the increase of water volume when the system is heated.

It can accept up to 7 l (1.5 gal) of expansion water. If the heating circuit has an unusually high water content, calculate the total

expansion and add an additional sealed expansion vessel with adequate capacity.

MAINS WATER FEED - CENTRAL HEATING:

There must be no direct connection to the mains water supply even through a non-return valve, without the approval of the Local Water Authority.

FILLING:

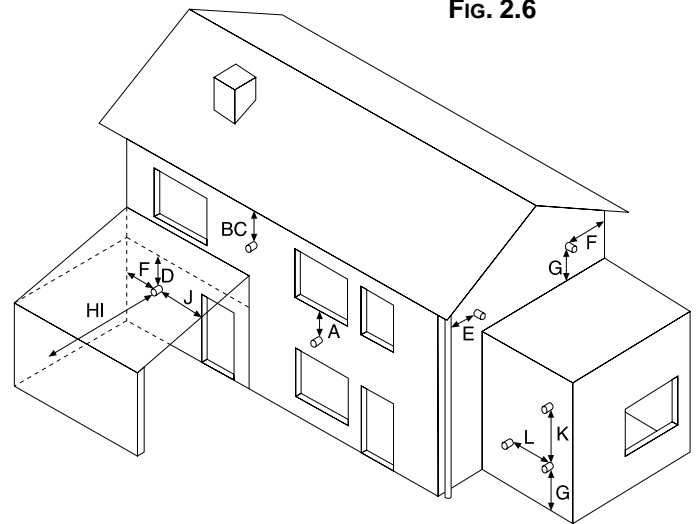
A temporary method for initially filling the system and replacing lost water during servicing and initial filling (in accordance with Water Supply Byelaw 14), is provided as an integral part of the connection kit (see Fig. 2.5). The flexible hose must be removed once the system has been filled. The D.H.W. inlet valve on the connection kit has two positions, one for winter and one for the summer. This enables the flow-rate through the appliance to be adjusted so that a sensible D.H.W. temperature may be achieved throughout the year.

DOMESTIC WATER

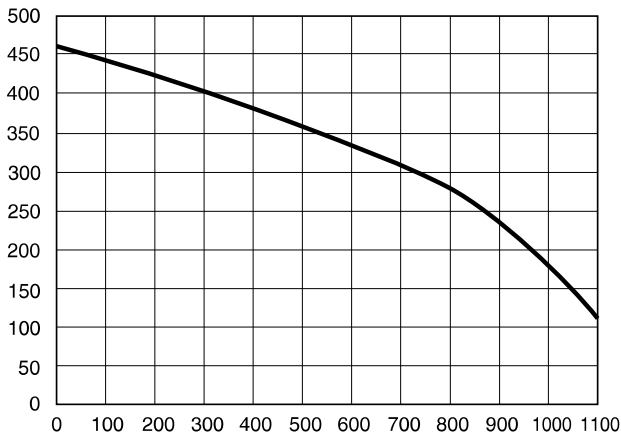
The domestic water must be in accordance with the relevant recommendation of BS 5546:1990. Copper tubing to BS EN 1057:1996 is recommended for water carrying pipe work and must be used for pipe work carrying drinking water.

The minimum acceptable spacing from the terminal to obstructions and ventilation openings are specified in Fig. 2.6

FIG. 2.6



RESIDUAL HEAD OF THE BOILER



TERMINAL POSITION

TERMINAL POSITION	mm
A - Directly below an open window or other opening	300
B - Below gutters, solid pipes or drain pipes	75
C - Below eaves	200
D - Below balconies or car-port roof	200
E - From vertical drain pipes and soil pipes	75
F - From internal or external corners	300
G - Above ground or below balcony level	300
H - From a surface facing a terminal	600
I - From a terminal facing a terminal	1200
J - From an opening in the car port (e.g. door, window) into dwelling	1200
K - Vertically from a terminal in the same wall	1500
L - Horizontally from a terminal in the same wall	300

In Fig. 2.11 below, several different types of flue systems are shown. For additional information regarding the flue accessories, please consult the Flue Pipe Accessories manual.

2.9. FLUE CONNECTIONS

FLUE SYSTEM

The provision for satisfactory flue termination must be made as described in BS 5440-1.

The appliance must be installed so that the flue terminal is exposed to outdoor air.

The terminal must not discharge into another room or space such as an outhouse or lean-to.

It is important that the position of the terminal allows a free passage of air across it at all times.

The terminal should be located with due regard for the damage or discolouration that might occur on buildings in the vicinity.

In cold or humid weather water vapour may condense on leaving the flue terminal.

The effect of such "steaming" must be considered.

If the terminal is less than 2 metres above a balcony, above ground or above a flat roof to which people have access, then a suitable terminal guard must be fitted.

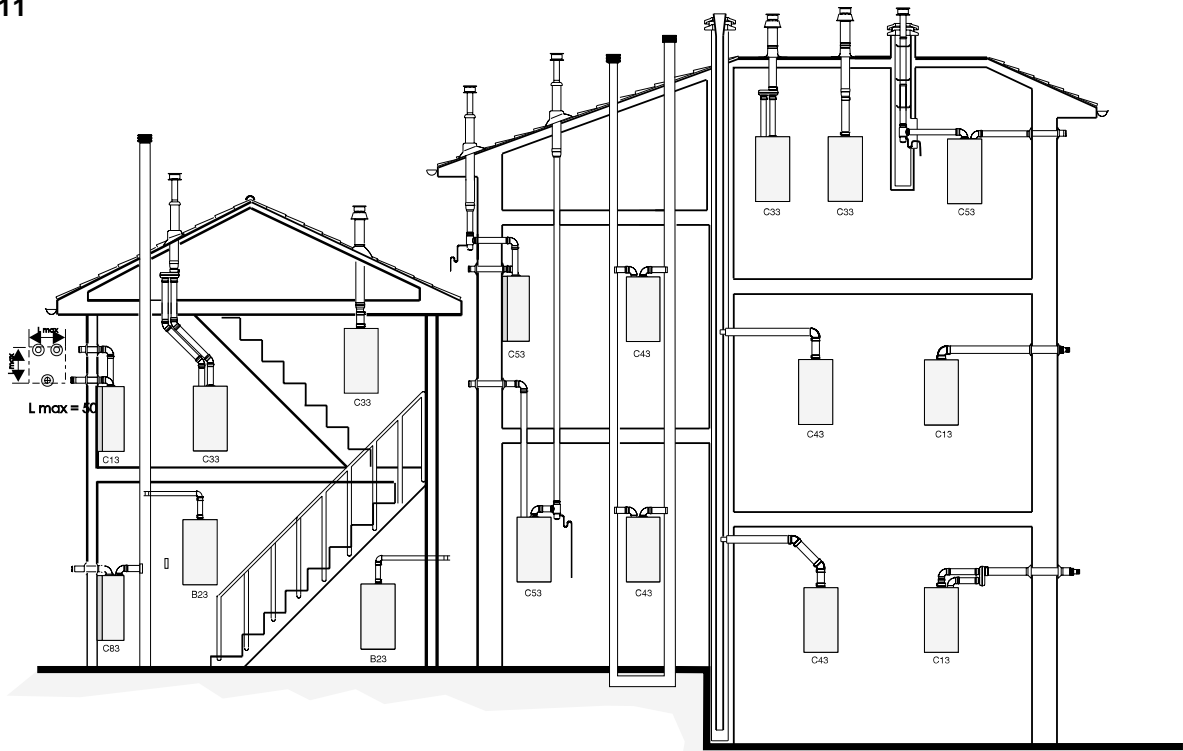
When ordering a terminal guard, quote the appliance model number.

A suitable terminal guard is available from:

TOWER FLUE COMPONENTS
Morley Road
Tonbridge
Kent TN9 1RA

	Exhaust Type	Maximum Extension Exhaust/Air (m)	Diameter of Pipes (mm)
Coaxial Systems	C ₁₃	4	Ø 60/100
	B ₃₃ outlet of fumes in chimney or exhaust flue	4	Ø 60/100
Twin Pipe Systems	C ₁₃ , C ₃₃ , C ₄₃	31 (S1=S2)	Ø 80/80
	C ₅₃ , C ₈₃	55 (S1+S2)	Ø 80/80
	B ₂₃	54 (S2)	Ø 80

Fig. 2.11



2.10. ACCESSORY CONNECTION

To carry out the connection for the roomstat or the outdoor sensor, proceed as follows:

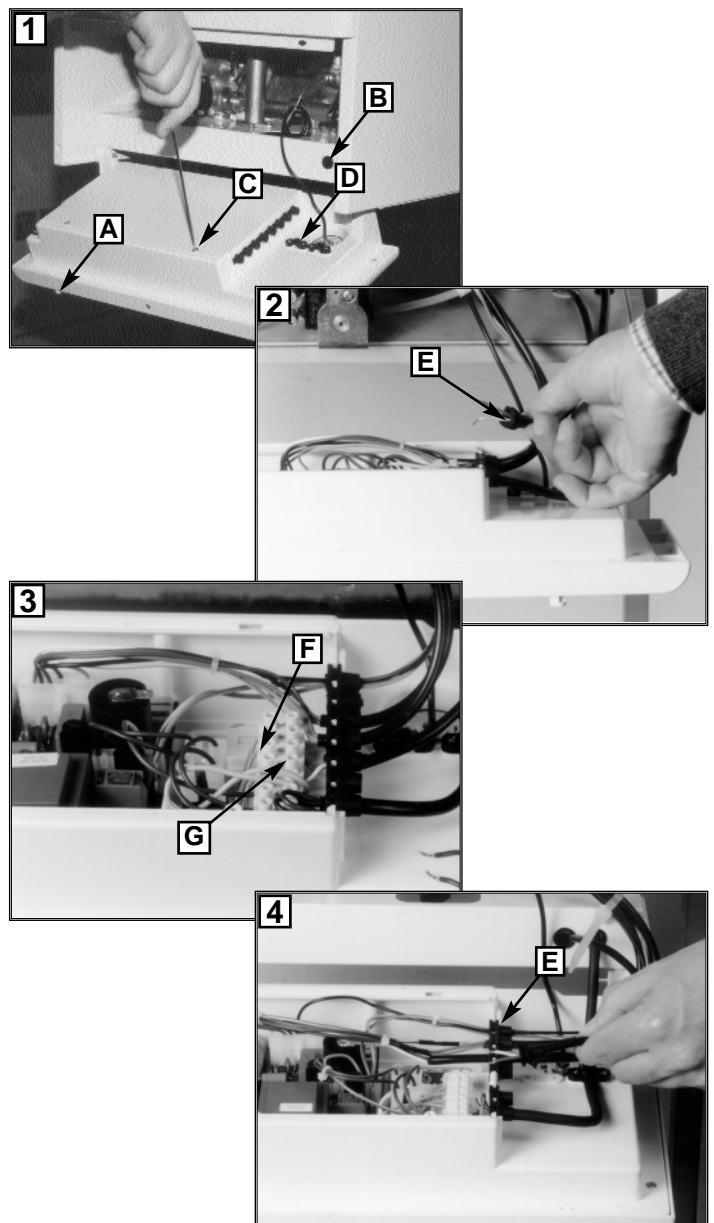
2.10.1. ROOM THERMOSTAT CONNECTION

1. Unscrew the screws "A" and rotate the control panel forwards;
2. Insert the connection cable for the thermostat or the outdoor sensor into the cable gland "B" and open the lid of the control panel after having first unscrewed fastening screws "C".
3. Insert the connecting cable into the cable clamp "D" shown in the figure and fasten it.
4. Remove the grommet "E" shown in the figure, make a hole in it and pass the connecting cable for the roomstat or the outdoor sensor through it.
- 5a. In order to connect up the roomstat, remove the link that is located in the "F" terminal (marked with the initials "TA") and connect the cables.
- 5b. To connect up the outdoor sensor, insert the cables into the "G" clamp (marked with the initials "SE").
6. Return the grommet "E" to its initial position, then close back the lid and lastly return the control panel to its place.
7. If a remote time clock is to be fitted, disconnect the integral time clock plug from the P.C.B.
8. Using a volt-free switching time clock, connect the switching wires from the time clock following points 1-6 above.
9. If using a time clock and room thermostat, these must be connected in series as per points 1-8 above.

Note: Only a two-wire type room thermostat can be used.

For details on fitting the D.H.W. probe (ecoGENUS 27 RFFI only), please consult the separate instruction sheet supplied with the probe.

An anti-frost device is built-in to the appliance's electronic regulation system.



2.10.2. REMOTE CONTROL CONNECTION

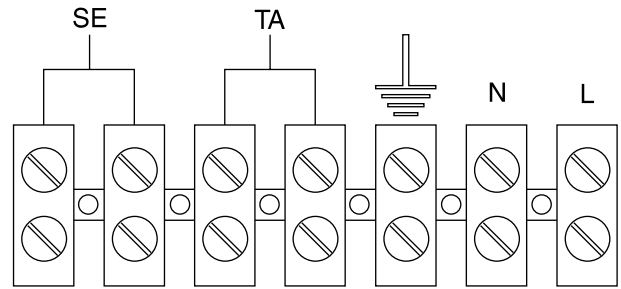
Refer to the illustrations in section 2.10.1.

1. Unscrew the screws "A" and rotate the control panel forwards.
2. Insert the connecting cables of the remote control into the cable gland "B" and open the lid of the control panel after having unscrewed the fastening screws "C".
3. Remove a blind grommet, make a hole in it and pass the connecting cable of the remote control through it.
4. Connect the cables of the remote control to the flying lead (see section 2.11.) connected to position C5 on the P.C.B. (positions with no closed jumper).
5. Bring the grommet back to its initial position, then close the lid and lastly the control panel.

NOTE: The wiring of the RC must be done by using 2 x 0.5 mm² cable this guarantees a maximum length of 500 m. The "BUS" cable of the RC must be wired separately from the 230 VAC cable.



2.10.3. ACCESSORY CONNECTION TERMINAL BLOCK



NOTE: The wiring of the Outdoor Sensor (SE) must be done by using 2 x 0.5 mm² cable this guarantees a maximum length of 50 m. The sensor must be positioned at least 2 - 2.5 m above the ground and where possible facing north. The sensor must not be exposed to direct sunlight.

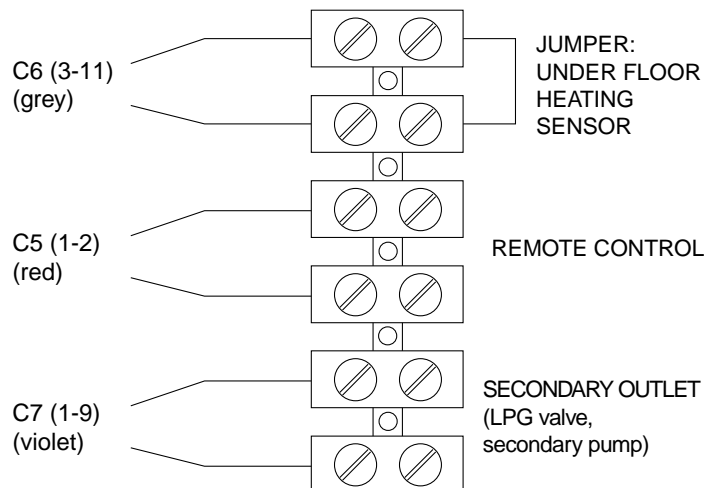
2.10.4. UNDER FLOOR HEATING CONNECTION

Refer to the illustrations in section 2.10.1.

1. Unscrew the screws "A" and rotate the control panel forwards.
2. Insert the connecting cable of the under floor heating sensor into the cable gland "B" and open the lid of the instrument panel after having unscrewed the fastening screws "C".
3. Remove a blind grommet, make a hole in it and insert the connecting cable of the under floor heating sensor through it.
4. Remove the jumper located in the flying clamp
5. Connect the cables of the under floor heating sensor to the flying clamp connected to position C6 on the P.C.B. (in place of the position previously occupied by the jumper).
6. Bring the grommet back to its initial position, close the lid and lastly the control panel.

2.10.5. REMOTE CONTROL TERMINAL BLOCK, CYLINDER PROBE AND SECONDARY OUTLET

CONNECTIONS TO THE P.C.B.

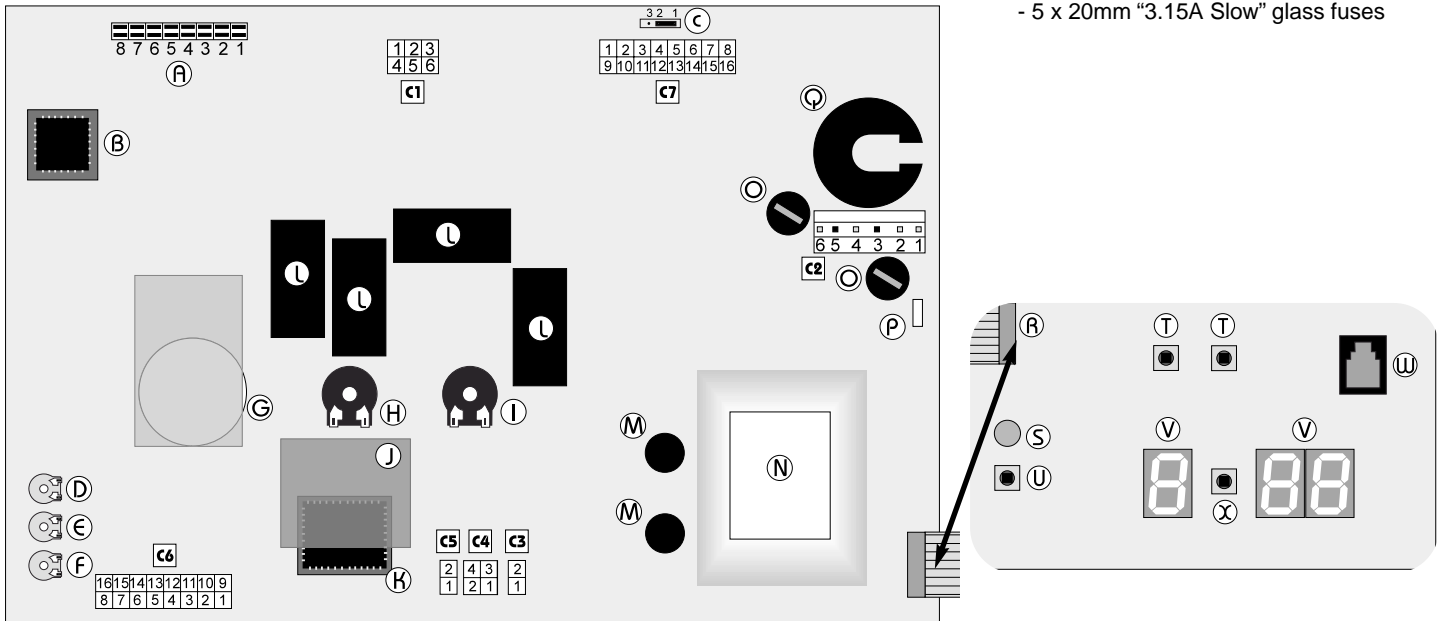


2.11. ELECTRICAL DIAGRAM

The P.C.B. is fitted with 2 fuses, on the live and the neutral.

The fuse holder contains:

- 5 x 20mm "3.15A Slow" glass fuses



LEGEND:

A: JUMPER

When needed, the P.C.B. allows the different options to be selected by means of a wire link.

The boiler has the following basic arrangement:

- 1 OPEN
- 2 CLOSED (jumper)
- 3 OPEN
- 4 OPEN
- 5 OPEN
- 6 OPEN
- 7 CLOSED
- 8 OPEN (MFFI); CLOSED (SYSTEM)

NOTE: under absolutely no circumstances must jumpers 2, 7 and 8 be removed. The opening of such contacts will lead to boiler malfunction.

This is the factory configuration. It is recommended that this set-up not be changed, unless under the following particular circumstances:

JUMPER 3: if the contact is closed, the Secondary Output (flying clamp connected to connection C7; positions 1-9) controls an LPG valve (optional).

JUMPER 4: if the contact is closed, the continuous operation of the pump is selected. If the contact remains open, it has no effect and there is no change in the operation of the boiler.

JUMPER 5: if the contact is closed, the signal transmitted by the connection of the secondary output clasp (connected to C7; positions 1-9) relates to a secondary pump (optional). If the contact remains open, the output signal controls a zone valve (optional).

JUMPER 6: not used

JUMPER 7/8:

7	8	CONFIGURATION
N.I.	N.I.	Central heating only
I.	N.I.	MFFI
N.I.	I.	Not used
I.	I.	RFFI System

I = inserted (contact closed)

N.I = not inserted (contact open)

NOTE: it is essential that the operations involving setting of the jumpers be carried out only with the device turned off.

B: Control microprocessor

C: Flame detection jumper (under no circumstances should this jumper be moved from the 1-2 position)

D: Anti-cycling device (RA)

E: Maximum heating output regulation (PR)

F: Soft-light regulation (RLA)

G: Operating mode selector knob

H: Heating temperature adjustment

I: Domestic hot water temperature adjustment

J: Remote control module

K: Main microprocessor

L: Relay

M: Fuses (2 x 0.54 A SLOW)

N: Transformer (PRI: 230V-50Hz; SEK: 10V-0,8VA; SEK: 10V-3,5VA; SEK: 10V-3,5VA;)

O: Fuses (2 x 3.15 A SLOW)

P: Earth

Q: Spark generator

R: Connection to the main P.C.B.

S: Comfort light

T: Programming keys

U: Comfort key

V: Alpha-numeric display

X: Set and reset key

W: Connection to PC

C1 = FAN

1: "Hall" sensor power supply 12V (red)

2: "Hall" sensor ground (blue)

3: Not used

4: Start of coil (black)

5: "Hall" sensor input (white)

6: End of coil (brown)

C2 = POWER SUPPLY

1: Earth (yellow/green)

2: Earth (yellow/green)

3: Not connected

4: Neutral (blue)

5: Not connected

6: Live (brown)

2.12. WATER CIRCUIT DIAGRAMS

GENUS 24 MFFI

C3 = CONNECTION TO ROOMSTAT

- 1: Input - 1
- 2: Input - 2

C4 = TIMER

- 1: 3 V output
- 2: Timer ground
- 3: Timer output
- 4: Not connected

C5 = REMOTE CONTROL (Bus+/Bus-)

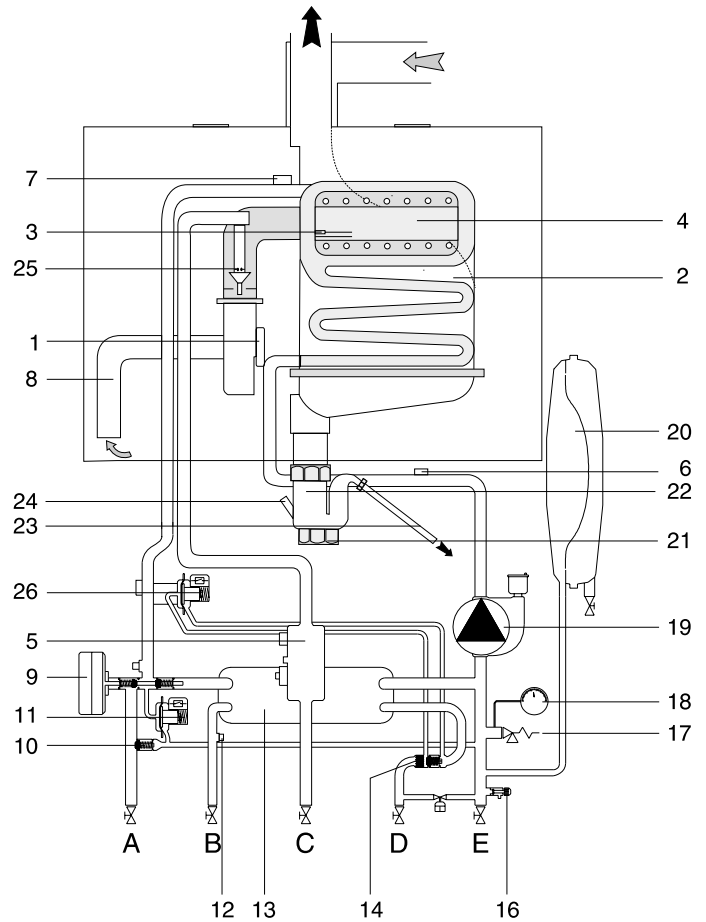
- 1: Input/output-1
- 2: Input/output-2

C6 = SENSOR CONNECTOR

- 1: Domestic hot water flow switch (grey)
- 2: Main circuit flow switch (grey)
- 3: Under floor heating thermostat (grey)
- 4: Heating flow sensor (grey)
- 5: Heating return sensor (grey)
- 6: Domestic hot water sensor (grey)
- 7: Not used: jumper
- 8: Outdoor sensor (grey)
- 9: Domestic hot water flow switch (grey)
- 10: Main circuit flow switch (grey)
- 11: Under floor heating thermostat (grey)
- 12: Flow sensor (grey)
- 13: Heating sensor (grey)
- 14: Domestic hot water sensor (grey)
- 15: Not used: under floor heating
- 16: Outdoor sensor (grey)

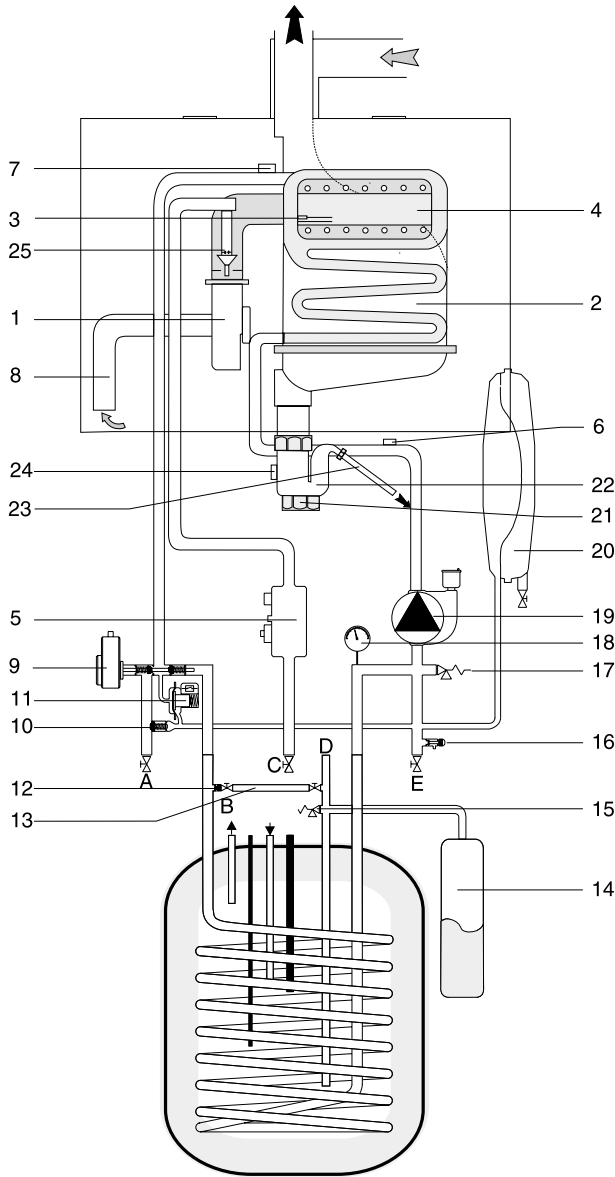
C7 = EQUIPMENT CONNECTIONS

- 1: Secondary output (optional)
- 2: Gas valve (white)
- 3: 3-way valve neutral (white)
- 4: Pump (white)
- 5: Ionisation (black)
- 6: Not connected
- 7: Ground
- 8: Pump earth (yellow/green)
- 9: Secondary output (optional)
- 10: Gas valve (brown)
- 11: 3-way valve (domestic hot water) (brown)
- 12: 3-way valve (heating) (brown)
- 13: Pump (brown)
- 14: Not connected
- 15: Earth
- 16: Gas valve earth (yellow/green)



LEGEND:

- 1 - Fan
- 2 - Main Heat exchanger
- 3 - Ignition/detection electrode
- 4 - Burner
- 5 - Gas valve
- 6 - Heating return temperature probe
- 7 - Heating flow temperature probe
- 8 - Silencer
- 9 - Motorised valve
- 10 - Automatic by-pass
- 11 - Main circuit flow switch
- 12 - Domestic hot water temperature probe
- 13 - Secondary heat exchanger
- 14 - Domestic hot water inlet filter
- 16 - Drain valve
- 17 - Safety valve
- 18 - Pressure gauge
- 19 - Circulation pump with automatic air release valve
- 20 - Expansion vessel
- 21 - Condensate trap inspection cap
- 22 - Condensate trap
- 23 - Condensate discharge tube
- 24 - Condensate trap inlet
- 25 - Injector
- 26 - Domestic hot water flow switch



LEGEND:

- 1 - Fan
- 2 - Main Heat exchanger
- 3 - Ignition/detection electrode
- 4 - Burner
- 5 - Gas valve
- 6 - Heating return temperature probe
- 7 - Heating flow temperature probe
- 8 - Silencer
- 9 - Motorised valve
- 10 - Automatic by-pass
- 11 - Main circuit flow switch
- 12 - Non-return valve (integral to Jig Kit)
- 13 - Filling loop (integral to Jig Kit)
- 14 - Indirect cylinder expansion vessel
- 15 - Expansion relief valve
- 16 - Drain valve
- 17 - Safety valve (3 bar)
- 18 - Pressure gauge
- 19 - Circulation pump with automatic air release valve
- 20 - Expansion vessel
- 21 - Condensate trap inspection cap
- 22 - Condensate trap
- 23 - Condensate discharge tube
- 24 - Condensate trap inlet
- 25 - Injector

3. COMMISSIONING

3.1. INITIAL PREPARATION

MTS (GB) Limited support the *benchmark* initiative. Within the information pack you will find a copy of the *benchmark* logbook. It is important that this is completed in the presence of your customer, they are shown how to use it, and it is signed by them. Please instruct your customer that they must have their *benchmark* logbook with them whenever they contact a service engineer or us. Preliminary electrical system checks to ensure electrical safety must be carried out by a competent person i.e. polarity, earth continuity, resistance to earth and short circuit.

FILLING THE HEATING SYSTEM:

Remove the panels of the case and lower the control panel (see section 3.2. for further information).

Open the central heating flow and return cocks supplied with the connection kit.

Unscrew the cap on the automatic air release valve one full turn and leave open permanently.

Close all air release valves on the central heating system.

Gradually open valve(s) at the filling point (filling-loop) connection to the central heating system until water is heard to flow, do not open fully.

Open each air release tap starting with the lower point and close it only when clear water, free of air, is visible.

Purge the air from the pump by unscrewing the pump plug and also manually rotate the pump shaft in the direction indicated by the pump label to ensure the pump is free.

Close the pump plug.

Continue filling the system until at least 1 bar registers on the pressure gauge.

Inspect the system for water soundness and remedy any leaks discovered.

FILLING OF THE D.H.W. SYSTEM:

Close all hot water draw-off taps.

Open the cold water inlet cock supplied with the connection kit.

Open slowly each draw-off tap and close it only when clear water, free of bubbles, is visible

GAS SUPPLY:

Inspect the entire installation including the gas meter, test for soundness and purge, all as described in BS 6891:1988.

Open the gas cock (supplied with the connection kit) to the appliance and check the gas connector on the appliance for leaks.

When the installation and filling are completed turn on the central heating system (sect. 3.4) and run it until the temperature has reached the boiler operating temperature.

The system must then be immediately flushed through.

The flushing procedure must be in line with BS 7593:1992 Code of practice for treatment of water in domestic hot water central heating systems.

During this operation, we highly recommend the use of a central heating flushing detergent (Ferrox Superfloc or equivalent), whose function is to dissolve any foreign matter that may be in the system.

Substances different from these could create serious problems to the pump or other components.

The use of an inhibitor in the system such as Ferrox MB-1 or equivalent is strongly recommended to prevent corrosion (sludge) damaging the boiler and system.

Failure to carry out this procedure may invalidate the appliance warranty.

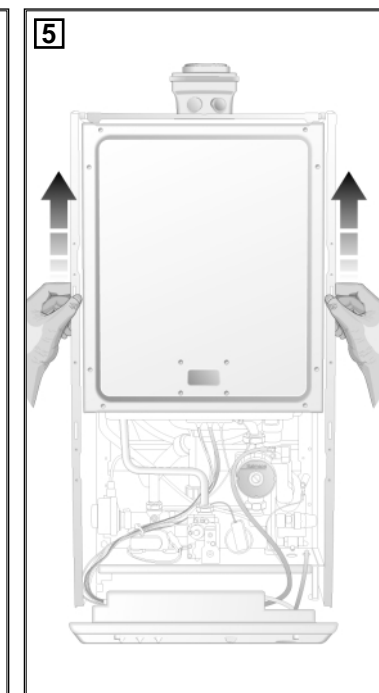
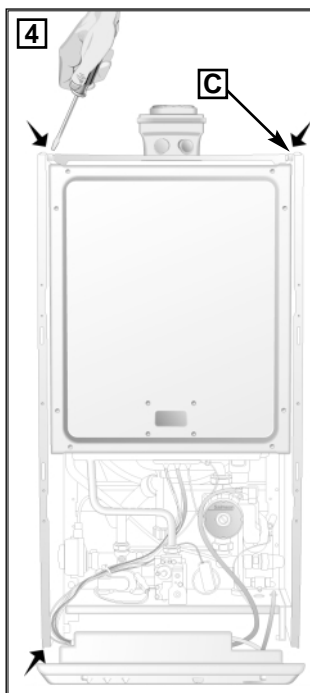
3.2. REMOVING THE CASING

To disassemble the front casing panel, follow these steps:

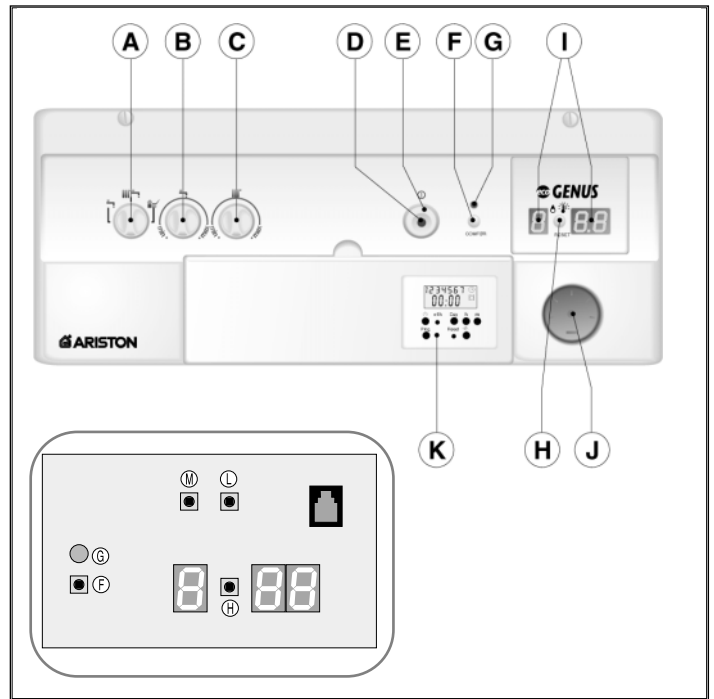
1. Unscrew the screws "A" (1/4 turn only) and rotate the control panel forwards;
2. Unscrew the screws "B";
3. Unhook the front panel of the casing by lifting it.

To disassemble the side panels, follow these steps:

4. Unscrew the screws "C" (at bottom) fastening the side panels;
5. Lift and unhook the panels.



3.3. CONTROL PANEL



- A. Selector Knob for Summer/Winter/Flue Test Modes
- B. Domestic Hot Water Temperature Adjustment Knob
- C. Central Heating Temperature Adjustment Knob
- D. On/Off L.E.D.
- E. On/Off Knob
- F. "COMFORT" Function Push-button/heating only (RFFI SYSTEM)
- G. "COMFORT" Function L.E.D./heating only (RFFI SYSTEM)
- H. Reset Button
- I. Multifunction Display
- J. Heating System Pressure Gauge
- K. Time Clock
- L. Programming "+" key
- M. Programming "-" key

3.4. INITIAL START-UP

When necessary configure the main P.C.B. according to the following diagram (please refer to the legend on page 17)

POSITION	INSERTED	NOT INSERTED
3	Secondary outlet (connection C7; positions 1-9) controls a LPG valve (optional).	The secondary outlet controls what is selected by Jumper 5.
4	Continuous pump operation.	No change in pump operation.
5	Secondary output relates to a secondary pump (optional).	Secondary output controls a zone valve (optional)

7	8	CONFIGURATION
N.I.	N.I.	Central heating only
I.	N.I.	MFFI
N.I.	I.	Not used
I.	I.	RFFI System

I = inserted (contact closed)

N.I = not inserted (contact open)

SECONDARY OUTLET = connection C7 (position 1-9 page 17)

1. Make sure that:

- the cap of the automatic air release valve is loosened;
- the system pressure is at least 1 bar on the pressure gauge;

- the gas cock is closed;
- the electrical connection has been carried out in the correct manner. To allow the air to escape from the system, proceed as follows:
- turn on the On/off knob “D” and position the selector knob “A” in the “winter” position. The boiler pump will start up and three consecutive attempts will be made to ignite the burner. After the third attempt, the electronic system will shutdown the boiler, because the supply of gas has been cut off. The message “A01” will appear on the display;
- let the pump operate until all the air has escaped from the system;
- repeat the procedure for bleeding the radiators of air;
- draw hot water for a short while;
- check the system pressure and, if it has gone down, fill it with water until it returns to 1 bar.

2. Check the flue system for products of combustion.
3. Check that any required local ventilation inlets are open.
4. **Fill the boiler condensate trap with water.**

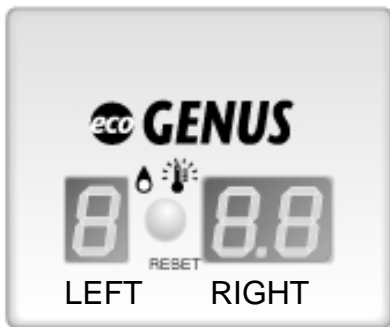
N.B. In the event of prolonged period of system shutdown, the condensate trap should be filled before any renewed use. A shortage of water in the trap is dangerous because it could possibly lead to a leakage of fumes into the air.

5. Turn on the gas cock and check the seals on the connections, including the one for the burner, making sure that the meter does not signal the passage of gas. Check the connections with a soap solution and eliminate any leaks.
6. Press the reset button “H” for the lighting system; the spark will light the main burner. If the burner does not light the first time, repeat the procedure.

The boiler is configured in the factory for the gas type in question. It is not necessary to regulate the gas type on installation.

NOTE: the reference values of the CO₂ are contained in the **TECHNICAL INFORMATION** section on page 4.

3.5. DISPLAY: MESSAGES SHOWN DURING NORMAL OPERATION



During operation of the boiler, while it is carrying out its normal operations, the left-hand display shows a series of characters that refer to the operations indicated below:

- Diagnostics phase (precedes the other operations)
- D* No request for heat
- L* Heating, burner off
- L* Heating, burner on
- c* Pump overrun for heating
- d* Domestic hot water, burner off
- d* Domestic hot water, burner on
- h* Pump overrun for domestic hot water
- b* Storage cylinder, burner off (SYSTEM version)
- b* Storage cylinder, burner on (SYSTEM version)

NOTE: the **flashing dot** on the left-hand display always indicates “burner off”; if the **still dot** indicates “burner on”.

The right-hand display (two-digit) shows:

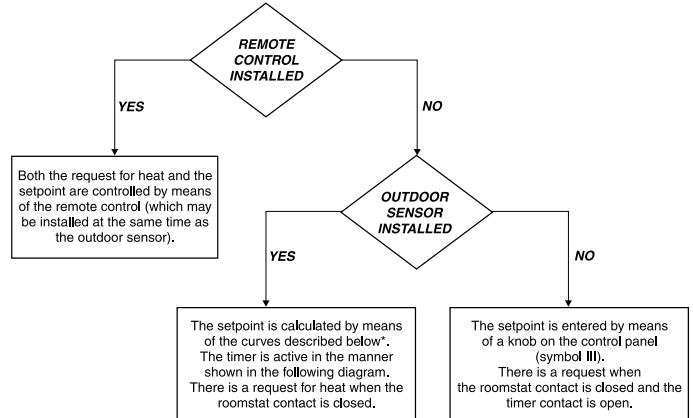
- in HEATING mode: temperature of the heating system flow;
- in DOMESTIC HOT WATER mode: temperature of domestic hot water.

3.6. OPERATING PARAMETERS

The boiler has been designed to allow easy intervention with regard to the operating parameters.

3.6.1. CONTROL MODES

The generation of the set-point and the request for heat are clarified in the following diagram, with regard to the heating mode.



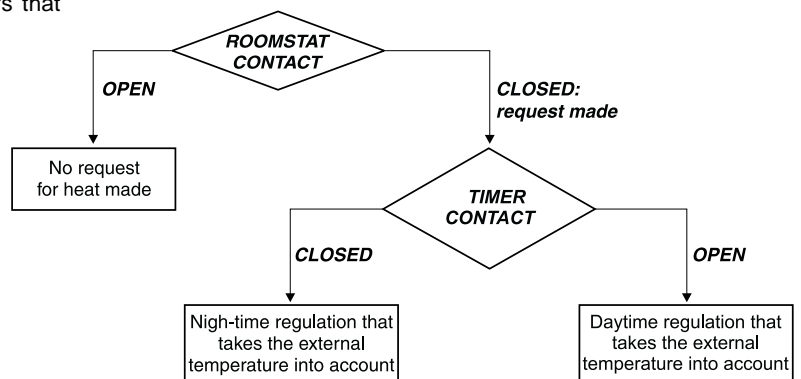
* See section 3.6.2.

The remote control and the timer are available as an accessory Kit: in the preceding diagram, it is clear that in the event that a device of this type is not installed, the calculation of the set-point depends on an outdoor sensor (if installed) and is carried out by the P.C.B.

NOTE: a configuration is also possible which allows for the simultaneous presence of a remote control and an outdoor sensor. In this case, the flow temperature is calculated as a function of the external temperature and the room temperature. In this manner, it is possible to carry out a particularly efficient modulation, which allows considerable comfort to be obtained, combined with savings in fuel. The influence of the roomstat and the timer are shown in the following diagram, taking into consideration the fact that:

- ON/OFF Room thermostat installed: contact open or closed, controlled by the room thermostat temperature sensor.
- ON/OFF Room thermostat not installed: contact closed (jumper).
- Timer installed: contact open or closed, controlled by the timer settings entered by the user.
- Timer not installed: contact open.

Schematic representation of the influence exerted by the roomstat and by the timer on the request for heat and on the calculation of the set-point (flow temperature of the primary circuit) by means of the external temperature values:

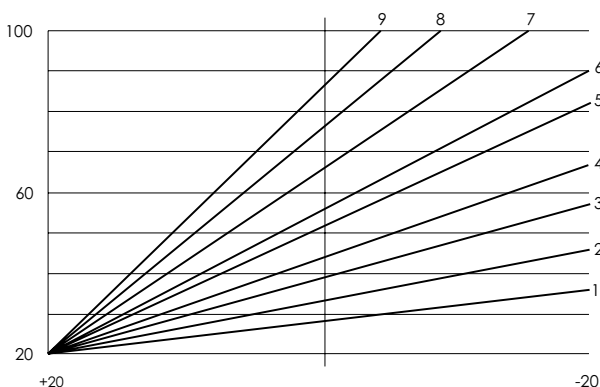


3.6.2. OUTDOOR SENSOR

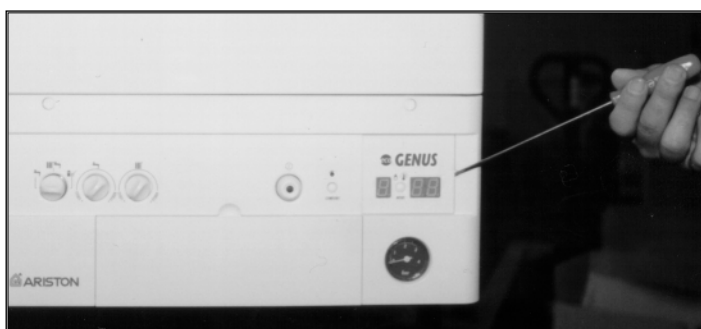
In the case of the use of an outdoor sensor, the microprocessor-controlled P.C.B. calculates the most suitable flow temperature, taking into account the external temperature and the type of system. The microprocessor is capable of doing this because it is possible to establish a link between the external temperature and the flow temperature of the heating system water. This link translates into a "thermal curve".

The type of curve should be chosen in correspondence with the planned temperature of the system and the nature of the heat loss present in the building.

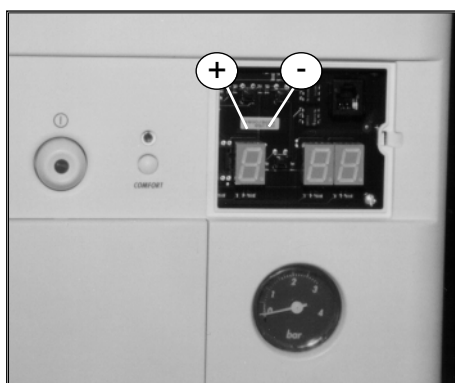
The flow temperature directly influences the room temperature, therefore making reference to the room temperature is equivalent to indicating variations in the temperature of the building.



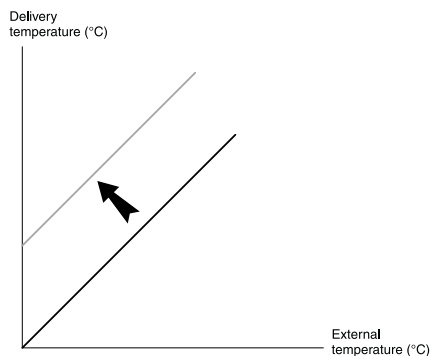
The type of curve is entered by means of the controls of the display P.C.B located under the lid of the P.C.B. itself. To access the programming buttons (+ / -), raise the lid with a screwdriver as shown in the illustration.



In the event of the chosen curve not being the most suitable for the type of system, it may be changed (selecting a more appropriate one) or moved until the desired thermal behaviour is obtained for the boiler and the system.



NB: The last effect achieved by adjusting the thermal curves is to change the behaviour of the system in relation to the room temperature. If the curve used has been selected underestimating the thermal needs of the building, i.e. it is too "low", it is possible that the building will not heat up sufficiently (the boiler will arrive to the set-point before the building reaches the desired temperature); the result is that the building will feel cold.

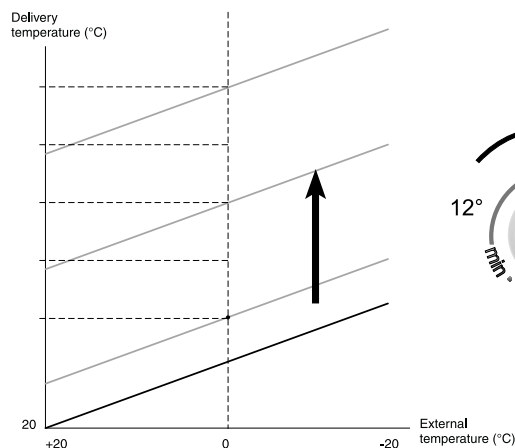


PROCEDURES AND PRACTICAL EXAMPLES:

If the building is always cold, under all external temperature conditions (and therefore in all seasons), the steps to take are as follows:

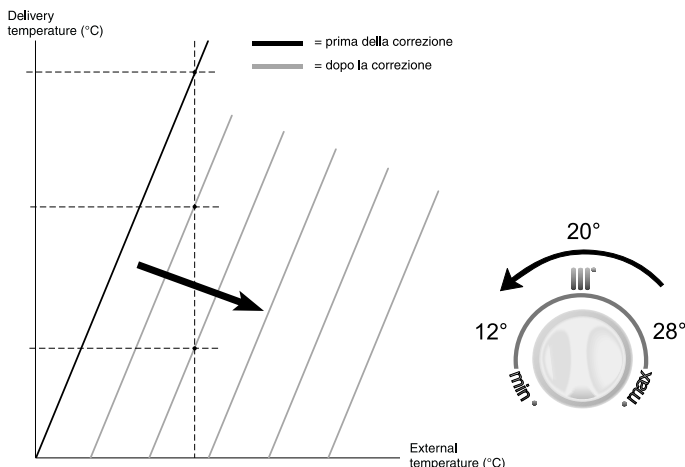
The curve must be translated parallel to itself, i.e. raising the flow temperature (and thereby the room temperature) in parity with the external temperature.

It is possible to carry out this operation by heating temperature knob. The knob in vertical position set a temperature of 20°C. Turning the knob on the right it's possible to set a higher room temperature.

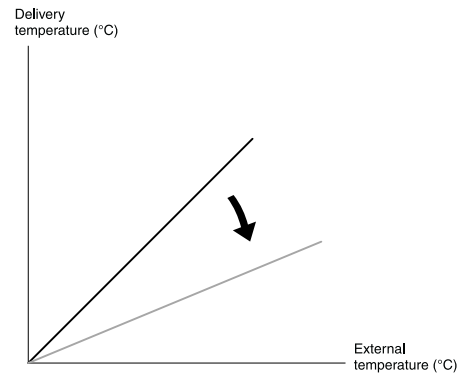
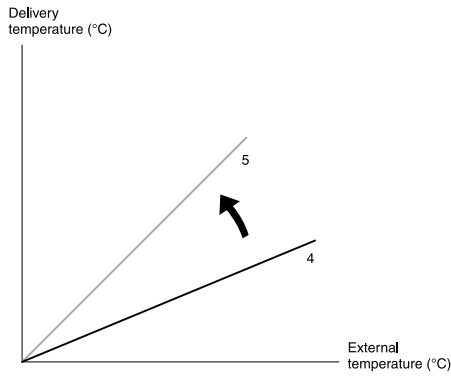


In this manner, temperatures for the water coming out of the boiler are set successively higher, which then influence the room temperature increasing it to the desired settings.

While turning the knob the display shows "d.xx" for few seconds, "xx" is the room temperature set. Alternatively, it is possible to lower the output temperature of the boiler if the room temperature is too hot. It is possible obtain this turning the knob on the left translating lower the curve.



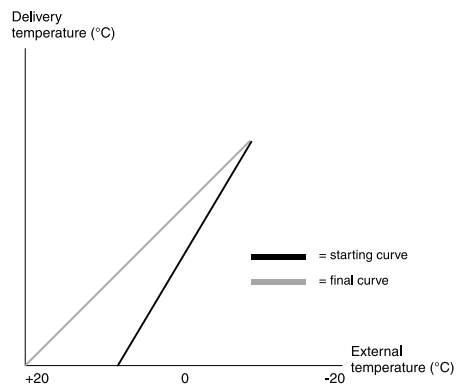
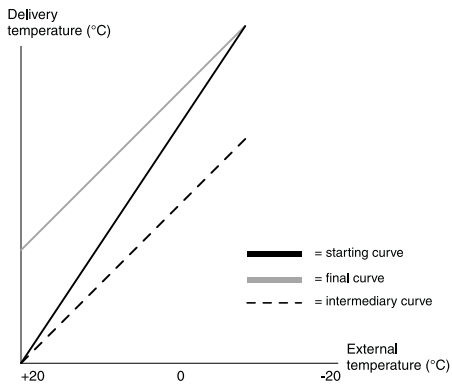
If the room temperature is too cold during the winter (while in spring the temperature is adequate), it is necessary to enter a steeper curve. To do this, press the reset button for 5 seconds and then press it repeatedly until the letter "F" appears (using the "+" and "-" keys). In this manner, the curves may be selected from 1 to 5.



Alternatively, if the building is too warm in the winter, while the room temperature is adequate in warmer seasons, it is necessary to choose a less steep curve, adjusting it in the same manner as above.

If the following situation occurs: with low external temperatures (e.g: winter, -20°C) the building is adequately heated, but with favourable climatic conditions (e.g: spring, +20°C) it is not sufficiently heated, it is necessary first to choose a lower curve ("F" on the display and then "-") and then turning the heating temperature knob.

In the opposite situation (in which the building is too hot in spring and adequately heated in winter), a higher curve ("d" and "+") must first be chosen and then "moved" turning the heating temperature knob.



The general conditions to follow upon installation are the following:
Warning (see 3.7.2)

- * The curves 1,2,3,4,5,6 could be set in the lower temperature;
- * The curves 5,6,7,8,9 could be set in the upper temperature;

CURVE 1: under floor heating (radiant panels at ultra-low temperature). Planned temperature 30/20°C.

CURVE 2-3: under floor heating (radiant panels, low temperature radiant plate systems). Planned temperature 40/30°C.

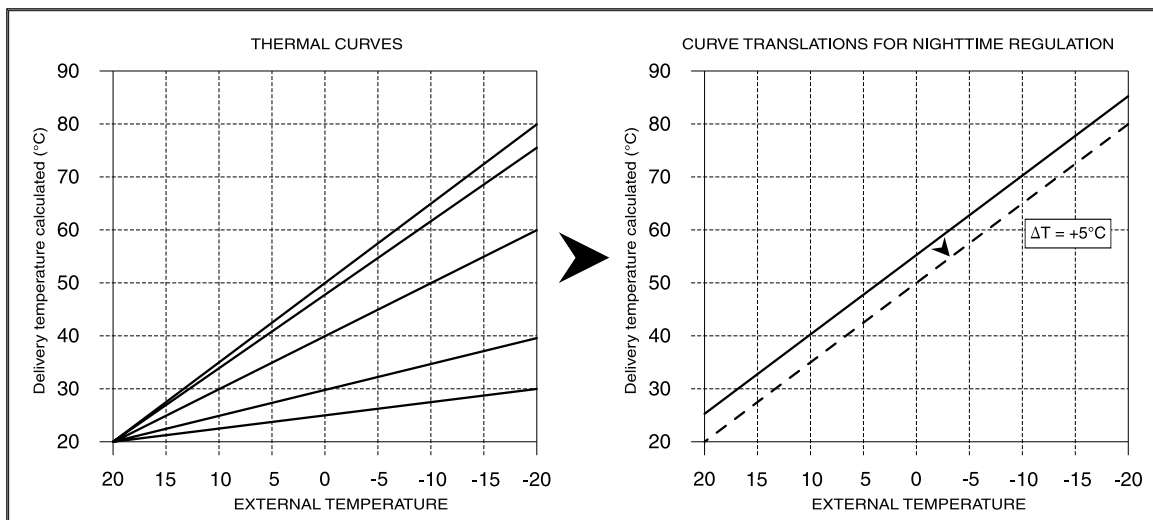
CURVE 4-5: conventional low temperature boilers (cast iron and aluminum radiators, radiant plate systems). Planned temperature 60/45°C.

CURVE 6-7: conventional low temperature boilers (cast iron and aluminum radiators, radiant plate systems). Planned temperature 75/60°C.

CURVE 8-9: boilers with higher temperatures (radiators, convectors, fan coils). Planned temperature 90/75°C.

For buildings with standard insulation, materials and exposure, it is recommended initially that the straight line not be moved parallel to itself. If a timer is installed, it is possible to set different temperatures for daytime and night-time. It is therefore possible to lower the temperature that the P.C.B. calculates in relation to the values provided by the outdoor sensor by a quantity decided by the user for night-time operation. To do this, it is necessary to select the night function "n", in the following manner:

- press the reset key for 5 seconds;
- press the same key again once to make the "n" character appear;
- using the programming keys "+" and "-", select a value from 0 to 12 depending on the amount of night-time lowering of the temperature desired.



3.6.3. SETTINGS DISPLAY

The boiler is designed to monitor some operating variables and settings by means of the display on the front control panel. Keeping the reset key pressed for over 10 seconds allows access to the "readout" function of the main system variables. By pressing the button repeatedly after that, it is possible to read the following information in sequence:

Indication on the left-hand display	Value read on right-hand display
U1	Flow temperature of the heating circuit (C°)
U2	Return temperature of the heating circuit (C°)
U5	Domestic hot water output temperature (C°)
UF	Ionisation current (expressed in bT)
U+	Main circuit flow switch
P/R	Heating ignition delay (see section 3.6.4. - expressed in min.x10)
P/-	Maximum thermal power for heating (expressed in a percentage of the difference between the maximum power allowed by the boiler and the minimum)
P/L	Soft light power (expressed in a percentage of the difference between the maximum power allowed by the boiler and the minimum)
b	Last safety shut-off (see section 3.7.)
l	Last shutdown (see section 3.7.)

To return to the normal display, press the "H" reset key repeatedly until all the sequence of "readout" functions have scrolled through the display and until one of the "display of normal operations" has appeared (the message that appears will depend on the current operating mode of the boiler).

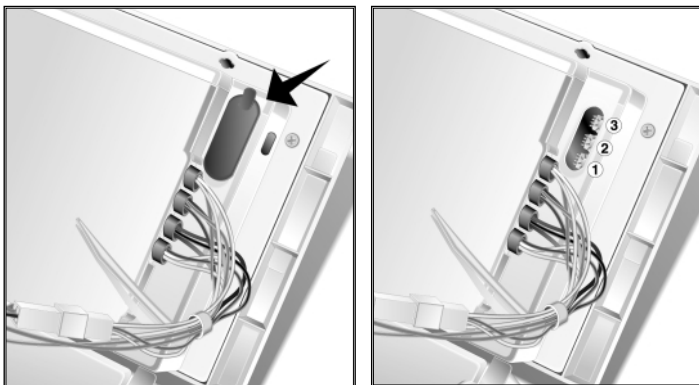
* **NOTE 1:** U/1 means that "u" and "1" blink alternately on the display

NOTE 2: the value 100% appears as "00" on the display

3.7. REGULATIONS

3.7.1. POTENTIOMETERS

To access the areas reserved for the regulation and control, open the control panel, after having first unscrewed the plastic fastening screws, and raise the rubber protection stopper for the potentiometers, as shown in the illustration.



This allows access to the three regulation potentiometers:

1. RA - Ignition delay (anti-cycling device) potentiometer

It is possible to set the ignition delay by adjusting the potentiometer with a screwdriver. The values that may be selected range from 0 to 15 min.

The delay has been set at 15 minutes in the factory. The value

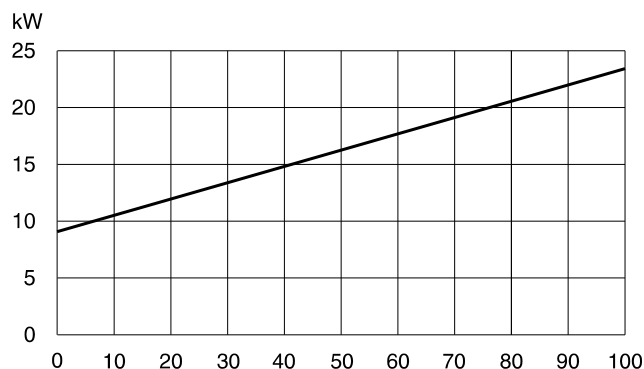
entered may be viewed in the manner described in section 3.6.3. (the display shows the value with steps of 10).

2. **PR - Maximum heating circuit power potentiometer**, variable between the maximum allowed by the boiler and the minimum (see "TECHNICAL INFORMATION" table). The boiler is calibrated in the factory at 70%.

3. **RLA - Soft-light potentiometer**, variable between the maximum power (shown on the display as "00", i.e. 100%) and minimum power (shown on the display as "01", i.e. 1%). The boiler is calibrated in the factory at a value which is suitable for ignition with any type of gas (approx. 70%).

The display shows the value between 100% ("00" on the display) and 1% ("01") of this interval. The indications on the display with regard to the power are shown in the graph:

DISPLAY MESSAGE REFERENCE



3.7.2. SETTING THE TEMPERATURE FIELD

Remove the protection of the display using a screwdriver as a lever. Press the reset button for over 5 seconds. The display will show "R03". On pressing the reset button again the display will change to "R00" (R indicates the setting of the field of regulation of the flow temperature). Using the button "E", the setting may be changed. It is possible to choose two fields of regulation of the flow temperature. "00" signifies that the flow temperature (which may be set by means of the knob on the front control panel) may be regulated from 30 to 75°C. "01" signifies that the flow temperature (which also may be set by means of the knob on the front control panel) may be regulated from 42 to 82 °C. The factory setting is "00".

3.7.3. COMFORT KEY:

GENUS 24 MFFI

The boiler allows the convenience level to be increased in the output of domestic hot water by means of the "COMFORT" function. This function keeps the secondary exchanger warm during the periods in which the boiler is inactive, thereby allowing the initial water drawn to be at a higher temperature. The function may be activated by pressing the "H" key on the control panel (see section 3.3.). When the function is active, a green light comes on, again located on the control panel.

NOTE: During the overrun period of the pump, the "COMFORT" function, if selected, is temporarily deactivated. The L.E.D. light remains on to indicate that the boiler will return to the "COMFORT" mode once the pump overrun is terminated.

HEATING ONLY KEY:

GENUS 24 RFFI

This function may be activated by pressing the "H" key on the control panel (see section 3.3.). When the function is active, a green light comes on, again located on the control panel. This indicates that the external indirect cylinder is not maintained at the set temperature, only the anti-frost protection of the indirect cylinder is active. When the temperature goes below 5°C, the boiler turns itself on and heats up the indirect cylinder until the temperature goes over 10°C.

3.7.4. PUMP OVERRUN

The pump overrun may be varied (after the burner has been turned off). To access this function, it is necessary to press the reset button for over 5 seconds and then press it repeatedly until the character "A" appears on the left-hand display.

The following modes are available:

A	1 minute of pump overrun
B	3 minutes of pump overrun
C	6 minutes of pump overrun
D	9 minutes of pump overrun
E	12 minutes of pump overrun
F	15 minutes of pump overrun
G	24 hours of pump overrun

It is also possible to set a continuous pump operation by closing the contact of jumper 4 (see section 2.12.).

3.7.6. REGULATION MENU TABLE

Summary of the functions accessed when the RESET button is pushed for 5 seconds.

Right Display	Left Display	Function	Note
A	01...24	pump overrun	see section 3.7.4.
r	00,01	period flow temperature	see section 3.7.2.
n	0...12	night-time lowering of the temperature	outdoor sensor parameters (section .3.6.2.)
F	1...5	curve incline	outdoor sensor parameters (section .3.6.2.)
S	81...89	do not use	the set value is 81
+	— --	test mode	see section 3.7.5.

3.8. BOILER SAFETY SYSTEMS

The boiler is protected from malfunctioning by means of internal checks by the P.C.B., which brings the boiler to a stop if necessary. In the event of the boiler being shut off in this manner, a code appears on the display which refers to the type of shut-off and the reason behind it.

There are two types of shut-off:


- **SAFETY SHUTDOWN**: these group of errors (characterised on the display by the letter "E") this situation is automatically removed as soon as the cause behind it is resolved. As soon as the origin of the shutdown disappears, the boiler starts up again and returns to its normal operation.
- **SHUTDOWN**: (characterised on the display by the letter "A"), it is not removed unless a manual intervention is made. The boiler may return to operation only if reset by means of pressing the button "H" (see illustration on page 18) located at the centre of the display.

There follows a list of the shutdown modes and the respective codes shown on the display.

Shutdown ("A" type): if such a situation occurs, it is necessary to reset the boiler using the appropriate key. If this shutdown occurs again, an Authorised Service Centre should be contacted.

3.7.5. TEST MODE

The P.C.B. allows the boiler to be forced to the maximum or minimum power.

To make the boiler operate at maximum power (100%: 24kW), it is necessary to turn the selector knob "A" (section 3.3.) and, using a light pressure, bring it to the <  > position. To return the boiler to its normal function, turn the selector "A" to the summer or winter position.

NOTE: To force the boiler to its maximum output it is necessary to completely rotate the potentiometer for maximum heating output regulation (PR).

DISPLAY	CAUSE
A01	<i>Too many attempts to ignite on starting up</i>
A02	<i>After three attempts at ignition, no increase in DT was detected</i>
A03	<i>The heating flow temperature exceeds 100°C during operation</i>
A07	<i>Too many failures to flame in one period during operation</i>
A1A	<i>The flame was detected after the gas valve had closed</i>
A20	<i>The flame was detected before the gas valve opened</i>
A21	<i>The flow switch does not close</i>
A22	<i>The flow switch does not open</i>
A33	<i>Problem with the fan</i>
A3A	<i>Problem with the electronic monitoring</i>

NOTE: When there is no ignition, check that the gas cock is open.

Safety shutdown: In the event that a safety shutdown occurs, it is necessary to contact an Authorised Service Centre.

DISPLAY	CAUSE
E03	Flow temperature over 100°C while boiler is not in operation (stand-by)
ESb	Heating flow temperature probe in open circuit
Ebb	Heating flow temperature probe short-circuited
EO4	Domestic hot water temperature probe in open circuit
EO5	Domestic hot water temperature probe in short circuit
EO8	Under floor heating temperature probe in open circuit
E20	Flame detected with gas valve closed
E21	Error in the electrical connection (live and neutral crossed)
E22	Problem with the 50Hz power supply
E23	Flame detection electrode short-circuited
Eb4	Heating return temperature probe in open circuit
ET4	Heating return temperature probe in short circuit
E99	Problem within the electronic system

There follows a description of the safety functions that most influence the behaviour of the boiler.

- 1. FLOW SWITCH.** At the beginning of every ignition sequence, the P.C.B. checks the operation of the main circuit flow switch. Initially, the pump is off and the flow switch must be open (not giving consent); if this does not occur within the space of a minute, the system carries out a shutdown. When the flow switch is open, the pump is turned on and within one minute the flow switch must close; if it does not do so, the monitoring mechanism shuts down the boiler (with the pump off). During normal operation, the flow switch must remain closed; if it opens for over two seconds, the boiler shuts down, then the monitoring mechanism will attempt to turn it back on.
- 2. FAN.** On ignition, the fan must rotate at the correct speed, otherwise the boiler will not attempt to turn itself on. During operation, the fan rotates at the speed set by the control P.C.B.; if the number of rotations deviates by more than 300 rpm from this setting, the boiler shuts off.
- 3. OVERHEATING.** This device shuts down the boiler in the event that the primary circuit reaches a temperature that exceeds 100°C. The operation of the overheat monitoring mechanism also includes the following precautionary measures:
 - After every ignition, the system flow temperature or the flow/return difference must increase by 3°C in 20 seconds. Until an increase of 3°C is reached, the boiler remains at the ignition power. If the increase in temperature does not come about, the boiler shuts down and will not attempt to re-ignite until the flow temperature is below 50°C. If after three attempts the temperature does not increase, the boiler shuts down.
 - Before the boiler attempts ignition, the system flow/return temperature difference must be below 20°C. In order for a successive attempt at ignition to be carried out, the system must register that once every 2 hours the flow/return temperature difference is below 5°C.
 - If, during operation the return temperature becomes greater than the flow temperature by more than 5°C, the boiler shuts down immediately.
- 4. DAILY TEST.** In order to prevent the shutdown of the components, the boiler carries out a self-diagnosing test every 24 hours: the pump turns on for 3 seconds and the diverter valve moves.
- 5. ANTI-FROST DEVICE.** The boiler is fitted with an anti-frost device consisting of three separate functions:
 - Monitoring of the system flow temperature: if this temperature goes below 5°C, the pump turns on (heating system circulation). If the temperature goes below 2°C, the boiler turns on at the minimum power and remains on until the return temperature is over 10°C.
 - Outdoor sensor installed: the pump turns on if the external

temperature goes below -3°C, it turns off when the external temperatures raises above -1°C.

- Continuous operation of the pump: select by means of jumper 4 (see paragraph 3.6.6.).

NOTE: In all cases, the circulation takes place in the heating system. The anti-frost device activates only when (with the boiler operating correctly):

- the system pressure is correct;
- the boiler is electrically powered;
- there is a supply of gas.

- 6. ANTI-SCALE DEVICE.** When producing domestic hot water, the burner shuts off whenever the output temperature of the hot water exceeds 62°C or the flow temperature of the primary circuit exceeds 72°C. It will not turn on if the temperature of the primary circuit is greater than 72°C.

3.9. COMBUSTION ANALYSIS

The boiler is designed to allow for easy analysis of the products of combustion.

Using the special traps, it is possible to detect the temperature of the burnt gas, the combustion air, the concentrations of O₂, CO₂, etc.



The maximum heating power test conditions may be optimised by turning the selector knob "C" to the flue test position.

3.5. DRAINING

The draining of the heating system must be carried out as follows:

- Turn off the boiler and the bipolar switch;
- Loosen the automatic air release valve (27);
- Open the system's discharge valve (18) and gather the water that comes out in a container;
- Empty out from the lowest points of the system (where provided).

If the system is to be left active in areas where the room temperature may go below 0°C during winter, it is recommended that anti-freeze liquid be added to the water in the heating system in order to avoid the need for repeated draining.

Draining the domestic hot water system

Every time that there is a danger of freezing, the domestic hot water system must be drained as follows:

- close the water mains stop-cock;
- open all the hot and cold water outlets;
- empty out from the lowest points (where provided).

4. GAS ADJUSTMENTS

4.1. OVERALL VIEW

NOTE: the values refer to the upper calorific power

Type of appliance	Natural Gas		LPG
Marking on the label of characteristics	LL	E	LPG
Further indications	Yellow adhesive label: calibrated for 'L' type methane Wo=11.5 Kw/m ³ (from 9.5 to 12.4 kWh/m ³)	Yellow adhesive label: calibrated for 'H' type methane Wo=14.1 Kw/m ³ (from 11.4 to 15.2 kWh/m ³)	Yellow adhesive label: calibrated for LPG Wo=24.3 Kw/m ³ (from 20.2 to 24.3 kWh/m ³)
Factory setting for the Wobbe Wo index in kWh/m ³	20mbar 11.5	20mbar 14.1	50mbar 24.3
Factory setting of the thermal capacity for the production of hot water	Maximum thermal power		
Factory setting of the thermal capacity for the heating	70% Maximum thermal power		

4.2. PRELIMINARIES

Check that the indication for type of appliance (category and type of gas calibration) reported on the label of characteristics corresponds to the gas family / group of the gas supply.

A	The type of of appliance does not correspond to the gas family of the gas supply	The appliance cannot be installed or put into operation.	
B	The type of appliance corresponds to the gas family of the gas supply	Domestic hot water: Heating:	Check the regulation according to section 4.3 In the event of the heating power setting being different from the thermal power setting required, the gas must be adjusted as in section 4.3. Otherwise, it is enough to check the correspondence.
C	The type of appliance does not correspond to the gas supply group (but corresponds to the family).	Domestic hot water: Heating:	Transform the boiler in accordance with section 4.5, after which: Check the regulation in accordance with 4.3 Carry out the gas regulation in accordance with point 4.3 in keeping with the thermal power requested.

4.3. GAS REGULATION

To regulate the gas, the sequence described below must be followed.

- Unscrew by 2 to 3 rotations the sealing screws marked "PE" of the pressure measurement inlet nipple
- Connect up a pressure gauge
- Place the appliance in operation in accordance with the usage manual
- Measure the connection pressure (dynamic pressure)

4.3.1. INLET PRESSURE TEST

This pressure, for methane gas, must be between 18 and 25 mbar. In the event that the pressure is outside of the above range, the boiler must not be placed in operation.

- Turn off the boiler.
- Remove the pressure gauge.
- Screw in the sealing screws of the pressure measurement inlet nipple and check the seal.

If it proves impossible to eliminate the defect, contact the gas supply board.

4.3.2. REGULATION OF THE THERMAL POWER

For the regulation of the gas in the ecoGENUS, two separate operations are required.

- Domestic hot water side (test only)
- Heating side (regulation and test)

A) DOMESTIC HOT WATER:

The thermal power for the hot water is set in the factory at the maximum power.

For this reason the boiler does not need any regulation of the gas from the "domestic hot water" side, just a test using the volumetric method at the gas meter:

- Make sure that there are no other gas appliances in operation during the test.
- Place the boiler in operation in accordance with the usage manual and draw hot water (tap totally open, temperature knob at 9).

NOTE: the test of the volumetric rate of flow must be carried out for at least two minutes of boiler operating time.

- Identify the volumetric rate of flow for the maximum thermal power from the table at the end of this section.

- Make a note of the value here. Value from table:l/min.
- Identify the volumetric rate of flow at the gas meter and compare it with that of the table.
- Differences greater than +/- 5 % are not allowed: contact the Authorised Service Centre and do not place the boiler in operation.

B) HEATING:

The thermal power is set in the factory at 70% of the maximum power (the potentiometer corresponds to the value on the display). In the event that this setting has to be changed, these steps should be followed:

- open the control panel after having unscrewed the plastic

fastening screws and lift up the rubber stopper protecting the potentiometers (see section 3.7.1.). Rotate the potentiometer PR to the desired point, checking the set thermal power on the display (as described in section 3.6.3.) and on the table below.

Test:

- Turn the selector knob "A" to the flue test position.
- Do not draw hot water.

NOTE: The test of the volumetric rate of flow must be carried out for at least five minutes of boiler operation.

- Identify the volumetric rate of flow from the table and make a note of it here.

Value from the table:l/min.

- Identify the volumetric rate of flow at the gas meter and compare it with that of the table.

Power in kW	8	10	12	14	16	18	20	22	24
Display message	01	13	25	39	50	68	74	88	00
Gas consumption (Natural Gas)	14.11	17.64	21.17	24.70	28.22	31.75	35.28	38.80	42.34
Gas consumption (LPG)	4.14	5.17	6.20	7.24	8.27	9.30	10.34	11.37	12.40

4.4. CHANGING THE TYPE OF GAS

The boiler may be transformed for use with LPG (G30-G31); the operation must be performed by an Authorised Service Centre.

The operations to carry out are the following:

1. Replacement of the nozzle (see table);
2. Replacement of the gas label;
3. Regulation of the slow ignition (refer to section 3.7 and the table in 4.3)

CATEGORY	NATURAL GAS	LPG	
	G20	G30	G31
• Diameter of 6 nozzle holes (mm)	2.7	1.7	1.7
• Display of recommended soft-light	70 (about 19 kW)	70 (about 19 kW)	70 (about 19 kW)

4.5. OPERATING TESTS

- Place the boiler in operation in accordance with the User's Manual.
- Check the seal on the gas and water sides.
- Check that the ignition operates correctly and visually check the burner flame.
- Check that the domestic hot water is being correctly produced by drawing hot water. Check the rate of flow and/or temperature of the water, depending on the case.
- Check that the condensate drips without difficulty into the discharge.

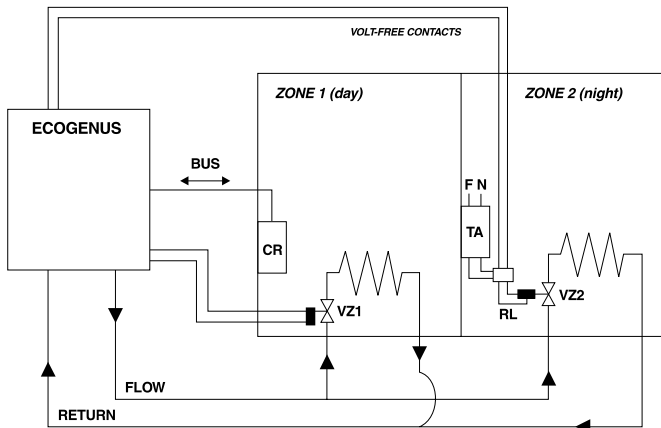
5. ZONE VALVES


The boiler is capable of managing a heating system that uses zone valves. The electrical connection of these valves is carried out by means of the appropriate terminal board (indicated in the “ELECTRICAL CONNECTION” section).

By way of example, two possible types of systems would be:

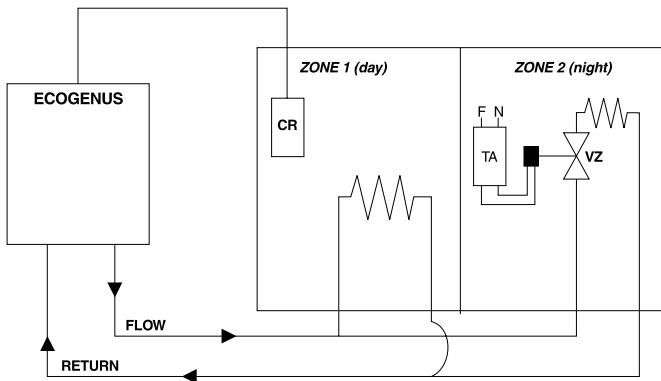
1. System with 2 valves with independent regulation of the zones (day and night).
2. System with 1 valve (regulation of the night zone subordinated to that of the day).

A possible set-up for the first type of system is as follows:



- CR = remote control
 VZ1,2 = zone valve 1 and 2
 TA = roomstat or timer-thermostat
 = radiators
 F,N = electrical connection (live and neutral)
 RL = relay

A possible set-up for the system with a single zone valve is as follows:



This set-up is simpler and more economical because it does not involve the use of the special relay. The night zone, however, may only be heated during the time periods in which the remote control timer gives consent to the heating of the day zone. Example:

- day zone programming (remote control): 8-22
- night zone programming (timer-thermostat): 20-22

6. MAINTENANCE

6.1. GENERAL REMARKS

It is recommended that the following inspections be carried out on the boiler at least once a year:

1. Check the seals in the water group and, if necessary, replace the gaskets and restore the seal to perfect working order.
2. Check the seals in the gas group and, if necessary, replace the gaskets and restore the seal to perfect working order.
3. Visually check the overall state of the boiler.
4. Visually check the combustion and, if necessary, disassemble and clean the burner.
5. Following inspection 3, disassemble and clean the combustion chamber, if necessary.
6. Following inspection 4, disassemble and clean the injector, if necessary.
7. Clean the primary heat exchanger (see section 6.2)
8. Regulate the correct rate of flow of the gas: rate of flow on ignition, partially loaded and at maximum load.
9. Check the correct functioning of the heating safety devices:
 - temperature limit safety device.
10. Check the correct functioning of the gas group safety devices:
 - absence of gas or flame safety device (Ionisation).
11. Check that the electrical connections are correct (in conformity with the instructions manual).
12. Check the efficiency of the production of domestic hot water (test the rate of flow and temperature).
13. Carry out a general inspection of the functioning of the boiler.
14. Check the characteristics for expulsion of the products of combustion.
15. Remove the oxide from the detection electrode by means of an emery cloth.

6.2. CLEANING THE PRIMARY EXCHANGER

CLEANING THE EXHAUST SIDE

Remove the combustion chamber inspection hatch (20) (see section 1.3). Check that the exhaust passages between the blades of the block are free; if there are deposits present, wash the blades with compressed air, water or a vinegar-based detergent.

NOTE: it is possible to use a brush in order to mechanically remove the residues.

Use of detergents:

- soak the blades well
- allow the detergent to act for about 20 minutes
- rinse with a strong jet of water to remove the deposits (the control panel must be kept closed)
- make sure that there are no traces of detergents in the exchanger.

CLEANING THE WATER SIDE

Use detergents that dissolve CaCO₃. Leave to act for a short time (in order not to damage the aluminum) and then rinse. Make sure that the detergent does not remain inside the exchanger.

6.3. CLEANING THE CONDENSATE TRAP

Unscrew the lower part of the condensate trap and clean it. Lastly, fill it with water and replace the stopper.


NB: if the boiler is not to be used for a prolonged period, the condensate trap should be filled before igniting it again. A shortage of water in the trap is dangerous because there is the risk of exhaust fumes escaping into the air.

6.4. OPERATIONAL TEST

After having carried out the maintenance operations, fill the heating circuit to a pressure of approx. 1.5 bar and release the air from the system. Also fill the domestic hot water system.

- Place the boiler in operation.
- If necessary, release the air again from the heating system.
- Check the settings and the correct functioning of all the control, regulation and monitoring parts.
- Check the seal and the correct functioning of the system for expelling fumes/drawing of combustion air.
- Check that the boiler ignites properly and carry out a visual check on the burner flame.

7. TECHNICAL INFORMATION

		24 MFFI	24 RFFI SYSTEM
Certification		63AT4528	63AT4528
Category		I12H3B/P	I12H3B/P
Thermal Capacity min/max	kW	8/24	8/24
Usable Thermal Power min/max (30/40°C)	kW	8.8/26.1	8.8/26.1
Usable Thermal Power min/max (60/80°C)	kW	7.9/23.3	7.9/23.3
Usable Thermal Power min/max (30/50°C)	kW	-/24.5	-/24.5
Power for Hot Water Production min/max	kW	7.9/23.3	7.9/23.3
Efficiency at Nominal Thermal Capacity (30/50°C)	%	102.2	102.2
Efficiency at 30% of Nominal Thermal Capacity (47°C of return)	%	96.4	96.4
Efficiency at 30% of Nominal Thermal Capacity (30°C of return)	%	103.6	103.6
Gas Consumption after 10 Minutes*	m ³	0.42	0.42
Maximum Heat Loss to the Casing ($\Delta T=50^{\circ}C$)	%	0.6	0.6
Flue Heat Loss with Burner Operating	%	2.1	2.1
Flue Heat Loss with Burner Off	%	0.2	0.2
Maximum Discharge of Fumes	Kg/h	35.1	35.1
Maximum Temperature of Discharge Fumes	°C	66.7	66.7
Temperature of Discharge Fumes when Heating 30/40°C (1 m of coax.)	°C	42.9	42.9
Minimum Room Temperature	°C	5	5
Heating Temperature min/max (High Temperature range)	°C	42/82	42/82
Heating Temperature min/max (Low Temperature range)	°C	30/75	30/75
Temperature of Water for Domestic Use min/max	°C	36/56	36/56
Class NOX		5	5
CO ₂ Content	%	9.3	9.3
O ₂ Content	%	4	4
CO Content	ppm	53.5	53.5
Inlet Pressure/Methane Gas G20 (boiler at maximum)	mbar	20	20
Inlet Pressure/Liquid Gas G30 - G31 (boiler at maximum)	mbar	30	30
Residual Discharge Head	mbar(Pa)	0.65(64)	0.65(64)
Maximum Head Loss on Water Side ($\Delta T=20^{\circ}C$)	mbar	200	200
Residual Head of System (60/80°C)	bar	0.2	0.2
Maximum Heating Pressure	bar	3	3
Maximum Water Content in System	l	130	130
Expansion Vessel Capacity	l	7	7
Expansion Vessel Pre-load Pressure	bar	1	1
Pressure of Water for Domestic Use min/max	bar	0.2/8-10	0.2/8-10
Nominal Capacity of Hot Water for Heating (residual head 0.25 bar)	l/h	820	820
D.H.W. Flow Rate: $\Delta T=25^{\circ}C$	l/min	13.4	---
$\Delta T=30^{\circ}C$	l/min	11.1	---
$\Delta T=35^{\circ}C$	l/min	9.6	---
D.H.W. Flow Minimum Rate	l/min	2.5	---
Quantity of Condensed Water with a (30/40°C)	l/h	1.8	1.8
pH Condensation Value		3.5÷4	3.5÷4
Electrical Supply	V/Hz	230/50	230/50
Power Consumption	W	130	130
Protection Grade of Electrical System	IP	4XD	4XD
Internal Fuse Rating	A	3.15 SLOW	3.15 SLOW
Width	mm	465	465
Height	mm	890	890
Depth	mm	385	385
Central Heating Connections	BSP	3/4	3/4
Domestic Hot Water Connections	BSP	1/2	1/2
Gas Connection	BSP	3/4	3/4
Net Weight	Kg	45	44.5
G.C. Number		41-116-17	41-116-03

Manufacturer: **Merloni TermoSanitari SpA - Italy**

*Calculated at 70% maximum output

Commercial subsidiary: **MTS (GB) LIMITED**

MTS Building
Hughenden Avenue
High Wycombe
Bucks HP13 5FT

Telephone: (01494) 755600

Fax: (01494) 459775

Internet: <http://www.mts.gb.ltd.uk>

E-mail: info@mtsgb.ltd.uk

Technical Service Hot Line: (01494) 539579

23 99 84 1439 112

eco **GENUS**

Condensing

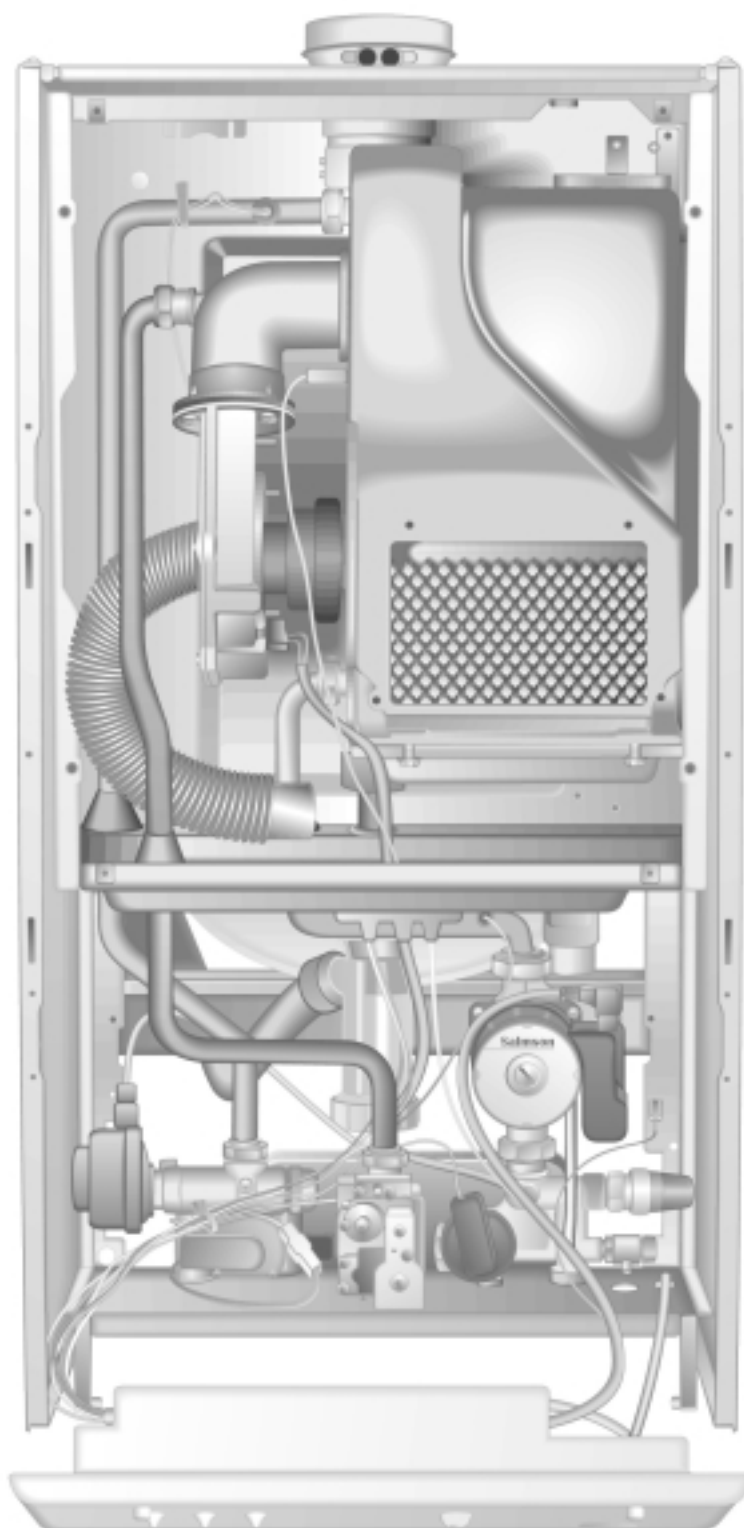
**Servicing
Instructions**

Type C Boilers

G.C.N: 41-116-03

47-116-17

**LEAVE THESE INSTRUCTIONS
WITH THE END-USER**



 **ARISTON**

Country of destination: GB

TABLE OF CONTENTS

1. **SERVICING INSTRUCTIONS**
 - 1.1 REPLACEMENT OF PARTS
 - 1.2 TO GAIN GENERAL ACCESS
 - Lowering the control panel and removing the front panel
 - Removing the side panels
 - 1.3 ACCESS TO THE COMBUSTION CHAMBER
 - Removing the sealed chamber front cover
 - Removing the fan
 - Removing the burner
 - Removing the electrodes
 - Removing the heat exchanger inspection panel
 - Removing the condensate collector
 - Removing the condensate trap
 - Removing the injector
 - 1.4 ACCESS TO THE GAS VALVE
 - Removing the gas valve
 - 1.5 ACCESS TO THE WATER CIRCUIT
 - Removing the D.H.W. (secondary) exchanger
 - Removing the safety valve
 - Removing the automatic air vent
 - Removing the main circuit flow switch
 - Removing the diverter valve actuator
 - Removing the D.H.W. flow switch
 - Removing the pump
 - Removing the pressure gauge
 - Removing the expansion vessel
 - Removing the D.H.W. temperature sensor (N.T.C.)
 - Removing the C.H. flow temperature sensor (N.T.C.)
 - Removing the C.H. return temperature sensor (N.T.C.)
 - 1.6 ACCESS TO THE CONTROL SYSTEM
 - Checking the fuses
 - Removing the time clock
 - Removing the P.C.B.s
2. **FAULT FINDING**
 - 2.1 FAULT FINDING GUIDE (FLOW-CHART)
3. **ELECTRICAL DIAGRAMS**
4. **SHORT SPARE PARTS LIST**

1. SERVICING INSTRUCTIONS

To ensure efficient safe operation, it is recommended that the boiler is serviced annually by a competent person.

Before starting any servicing work, ensure both the gas and electrical supplies to the boiler are isolated and the boiler is cool.

Before and after servicing, a combustion analysis should be made via the flue sampling point (please refer to the Installation Manual for further details).

After servicing, preliminary electrical system checks must be carried out to ensure electrical safety (i.e. polarity, earth continuity, resistance to earth and short circuit).

1.1 REPLACEMENT OF PARTS

The life of individual components vary and they will need servicing or replacing as and when faults develop.

The fault finding sequence chart in chapter 2 will help to locate which component is the cause of any malfunction, and instructions for removal, inspection and replacement of the individual parts are given in the following pages.

1.2 TO GAIN GENERAL ACCESS

All testing and maintenance operations on the boiler require the control panel to be lowered. This will also require the removal of the casing.

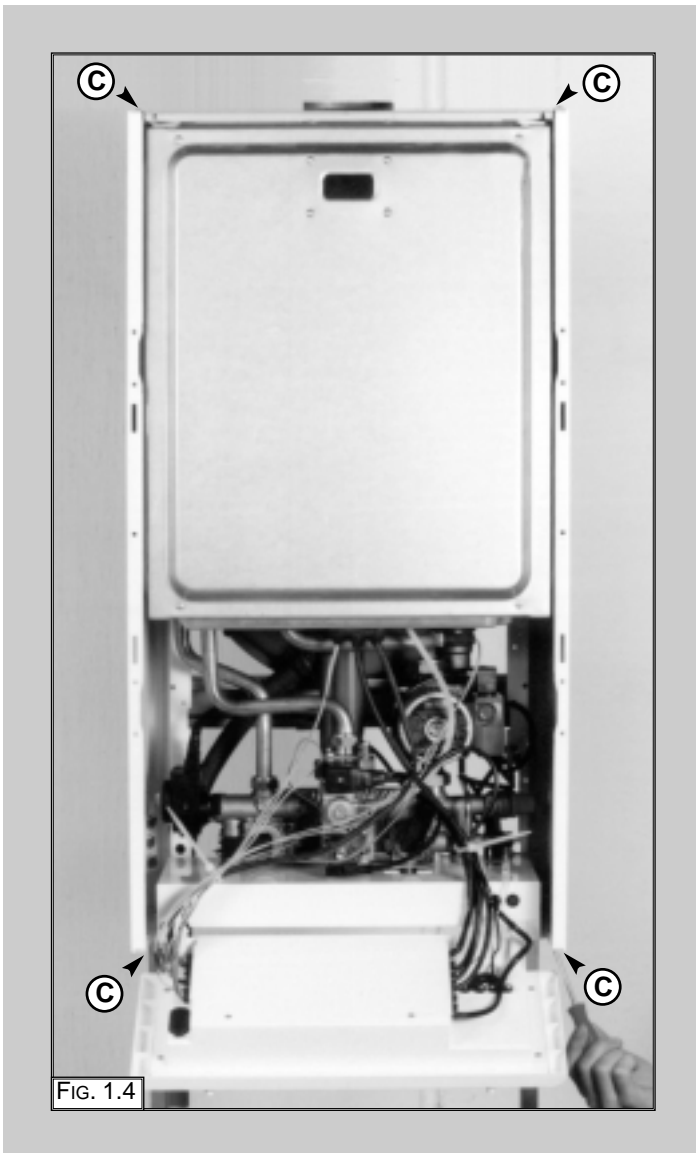
To lower the control panel and dismantle the front part of the casing, proceed as follows:

1. Unscrew screws "A" (1/4 turn only) (FIG. 1.1 + FIG. 1.2) and rotate the control panel forward;
2. Unscrew the screws "B" (FIG. 1.3) and unhook the front panel by lifting it.



Removing the side panels

1. Remove the screws "C" (FIG. 1.4);
2. Pull each panel away from the boiler, then lift the panel up and away from the boiler.



1.3 ACCESS TO THE COMBUSTION CHAMBER

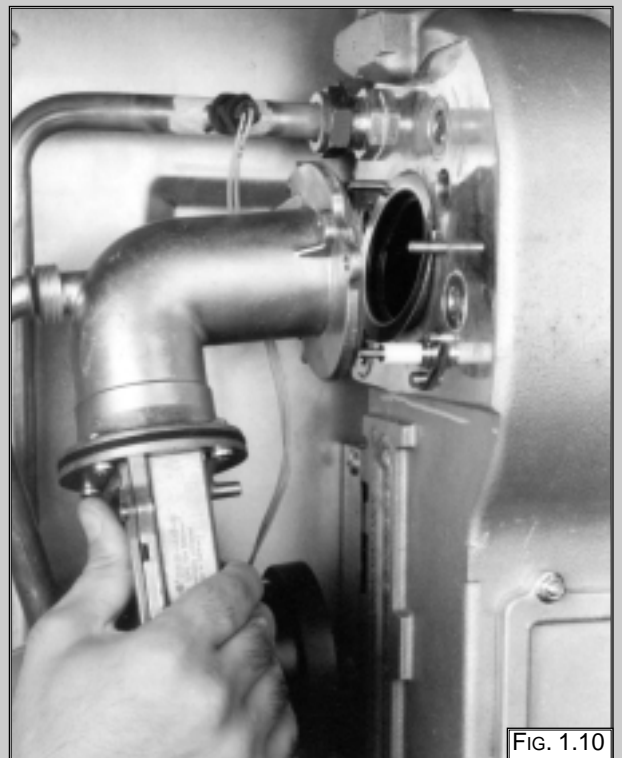
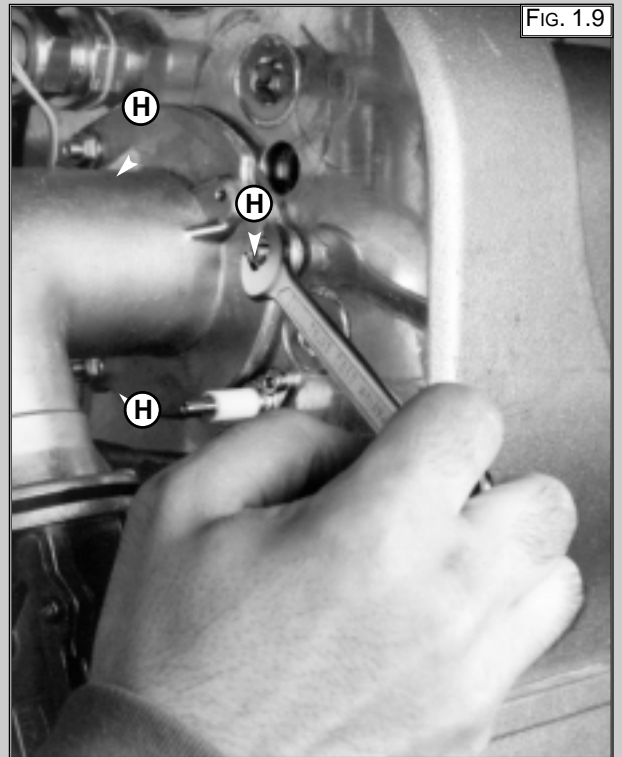
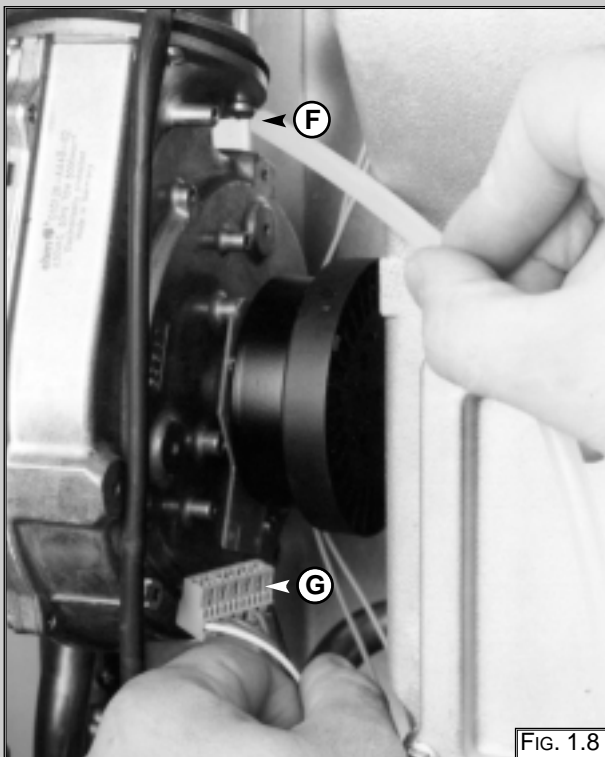
Removing the sealed chamber front cover

1. Remove the screws "D" (FIG. 1.5);
2. Pull the cover away from the boiler (FIG. 1.6).



Removing the fan

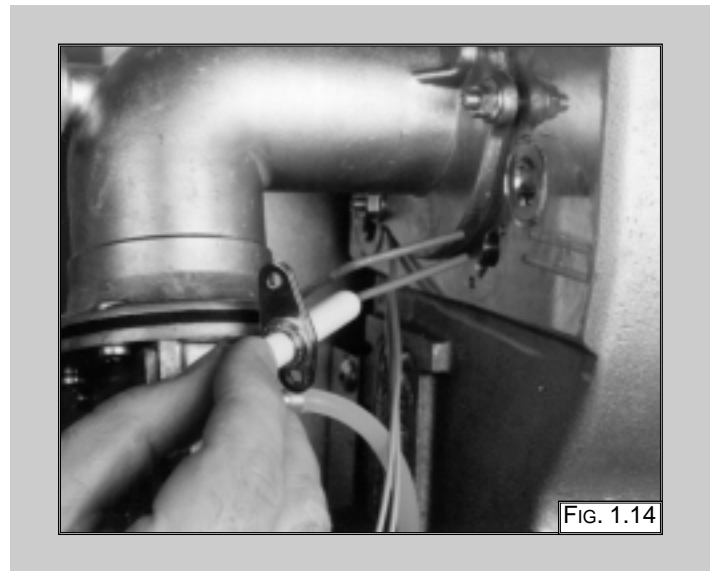
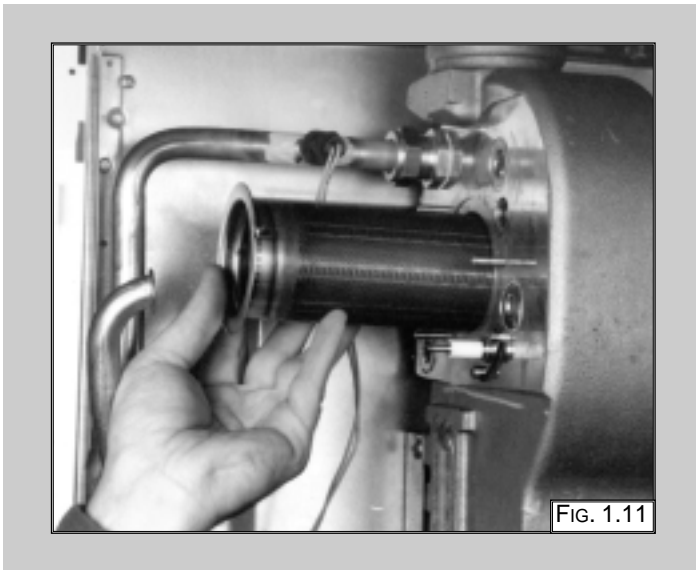
1. Loosen nut "E" (FIG. 1.7);
2. Pull off the hose "F" and disconnect the electrical connector "G" (FIG. 1.8);
3. Remove the nuts "H" (FIG. 1.9);
4. Pull the fan away from the exchanger (FIG. 1.10).



Removing the burner

With the fan removed (see previous section);

1. Slide the burner from its housing (FIG. 1.11).

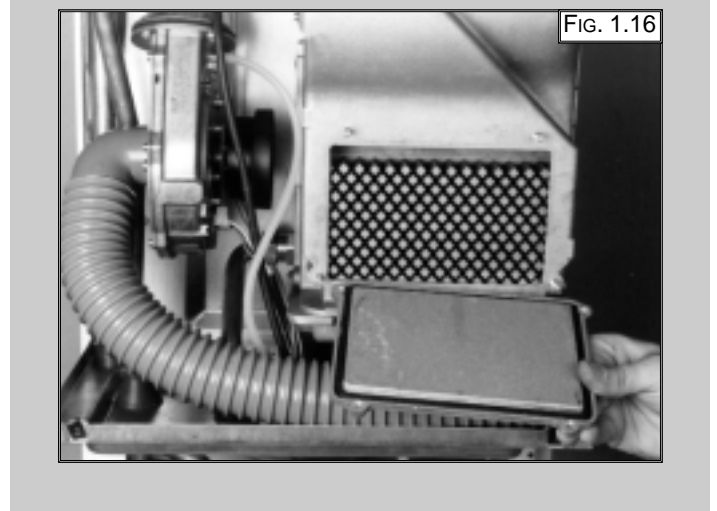
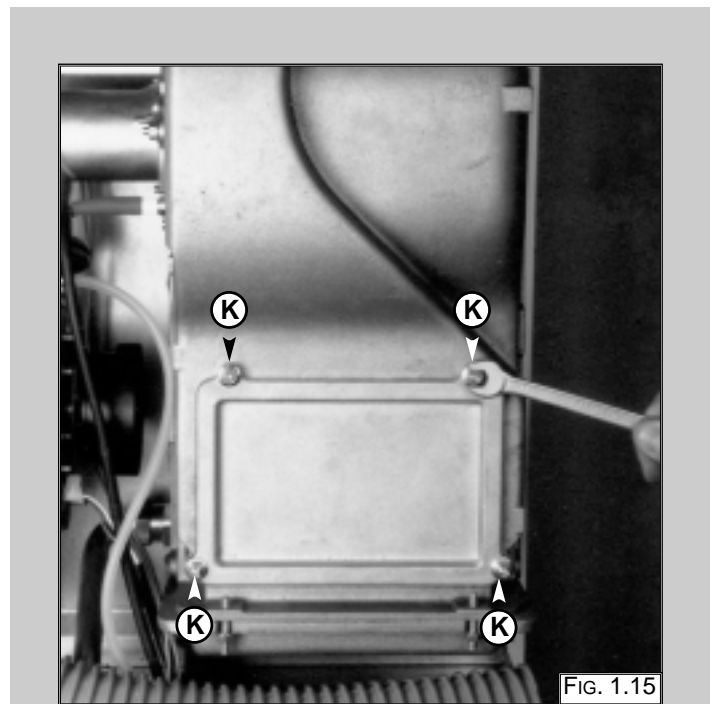
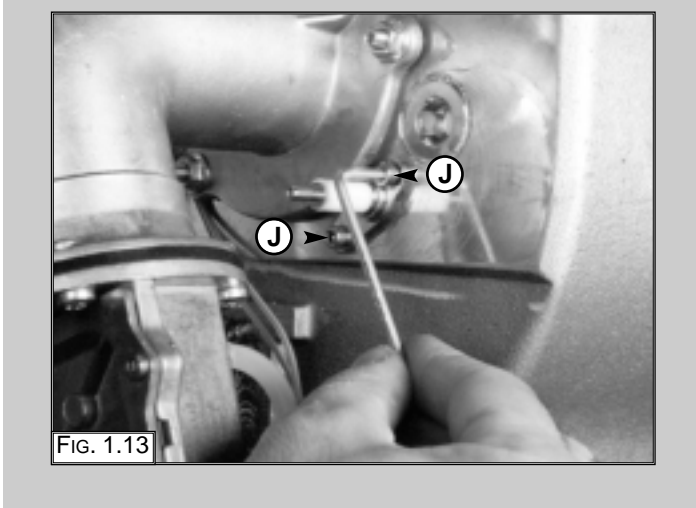
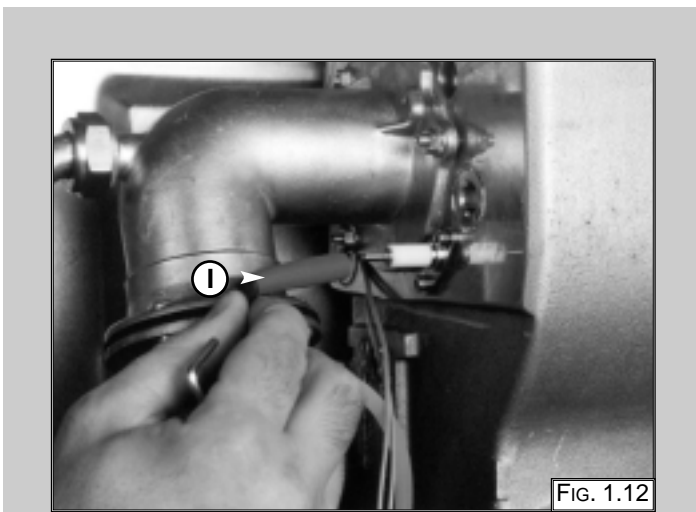


Removing the combustion chamber inspection panel

1. Remove the four nuts "K" (FIG. 1.15);
2. Remove the inspection panel (FIG. 1.16).

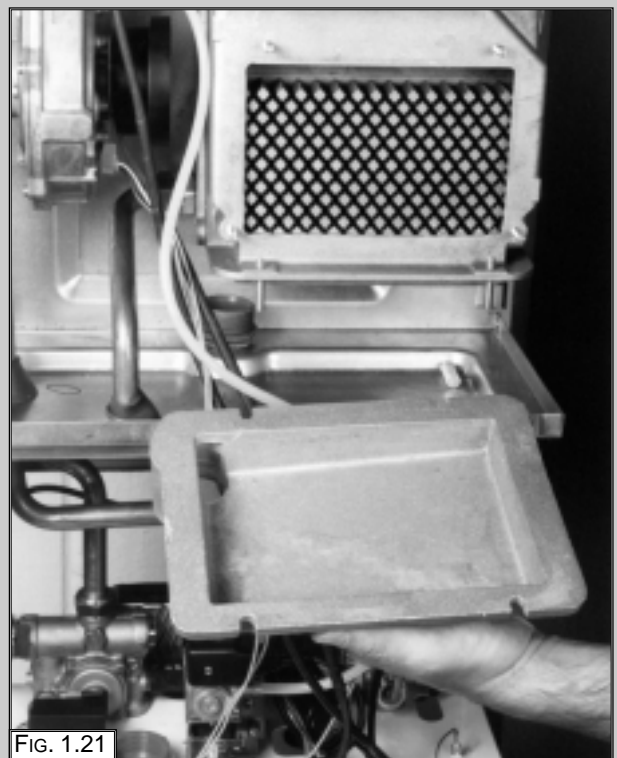
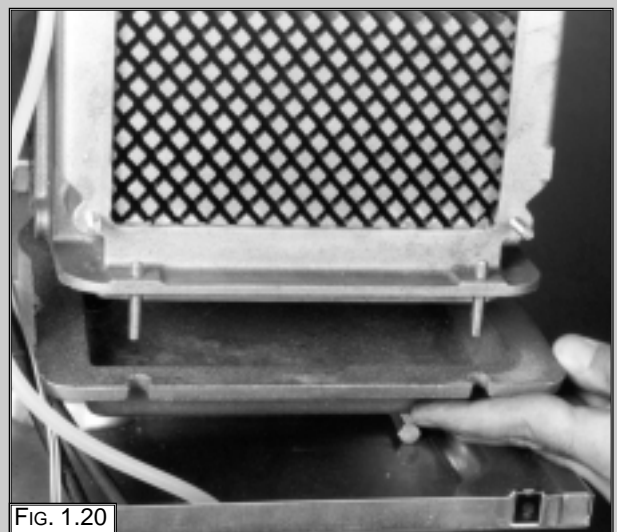
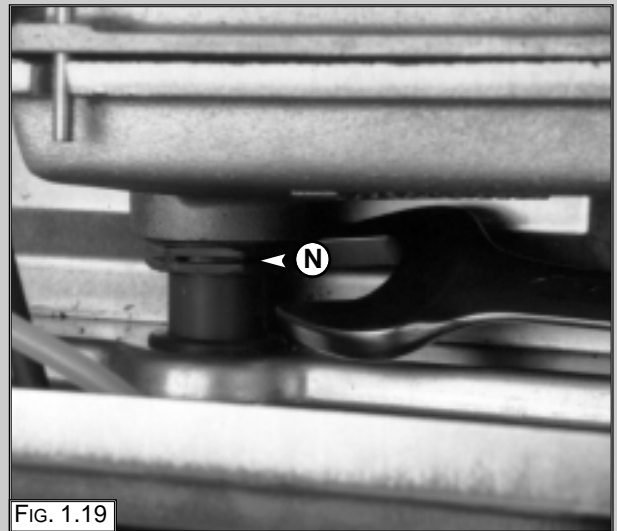
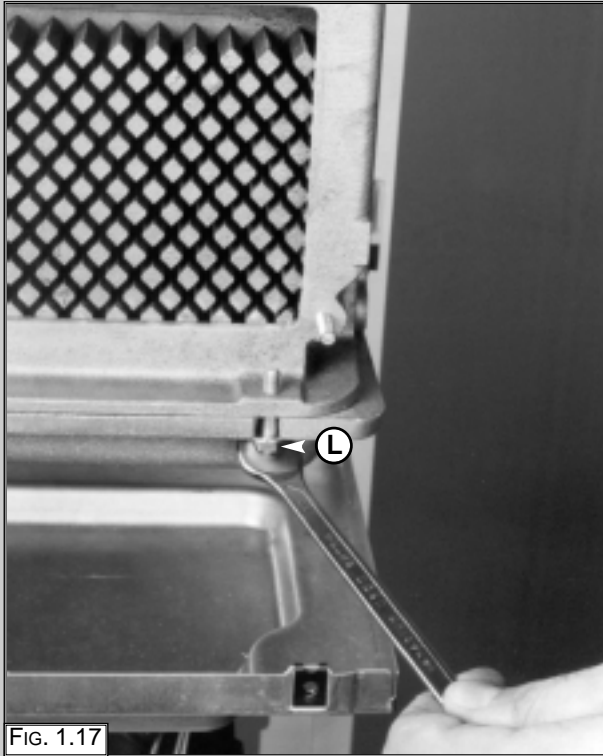
Removing the electrodes

1. Pull off the ignition cable "I" (FIG. 1.12);
2. Remove the two allen bolts "J" (FIG. 1.13);
3. Extract the electrodes (FIG. 1.14).



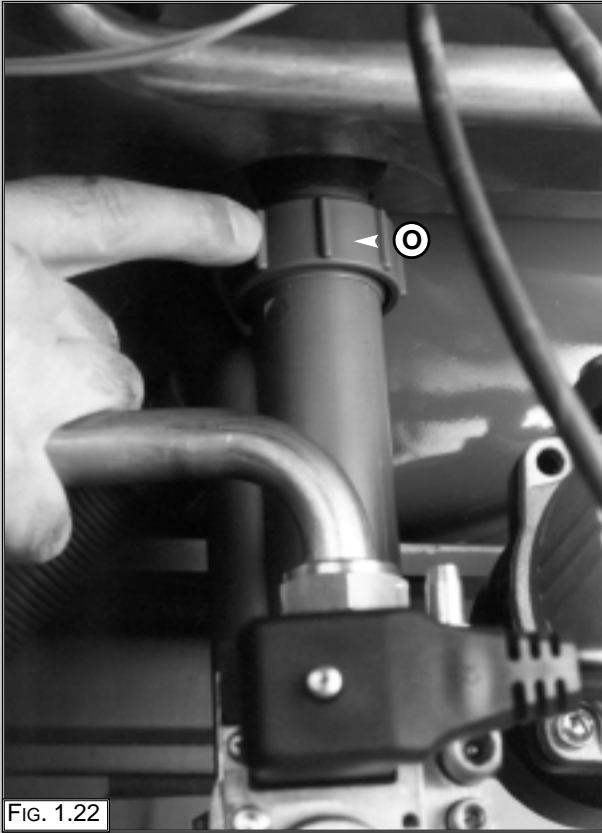
Removing the condensate collector

1. Remove the nuts "L" from each side of front of the collector (FIG. 1.17);
2. Remove the nuts "M" from each side of rear of the collector (FIG. 1.18);
3. Release the condensate trap union "N" (FIG. 1.19);
4. Separate the collector from the combustion chamber(FIG. 1.20);
5. Remove the condensate collector (FIG. 1.21).



Removing the condensate trap

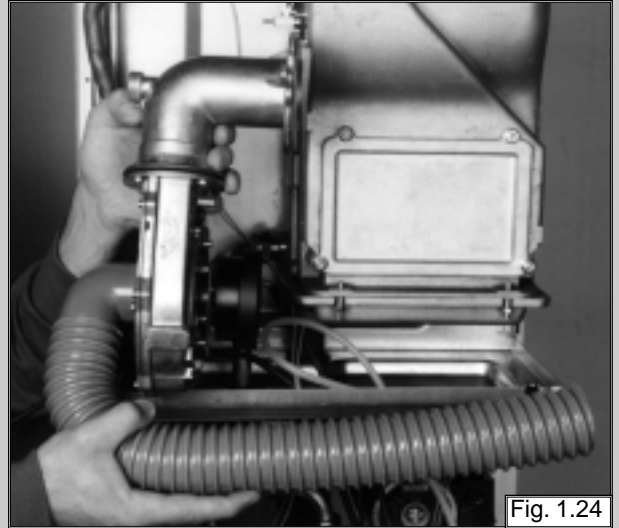
1. Loosen the union "O" (FIG. 1.22);
2. Remove the condensate trap (FIG. 1.23).



Removing the injector

See the section on removing the fan before carrying out this procedure

1. Disconnect all connections from the fan and remove (FIG. 1.24);
2. Remove the four screws "P" (FIG. 1.25);
3. Unscrew the injector "Q" using a suitable screwdriver (FIG. 1.26);
4. Remove the injector (FIG. 1.27).



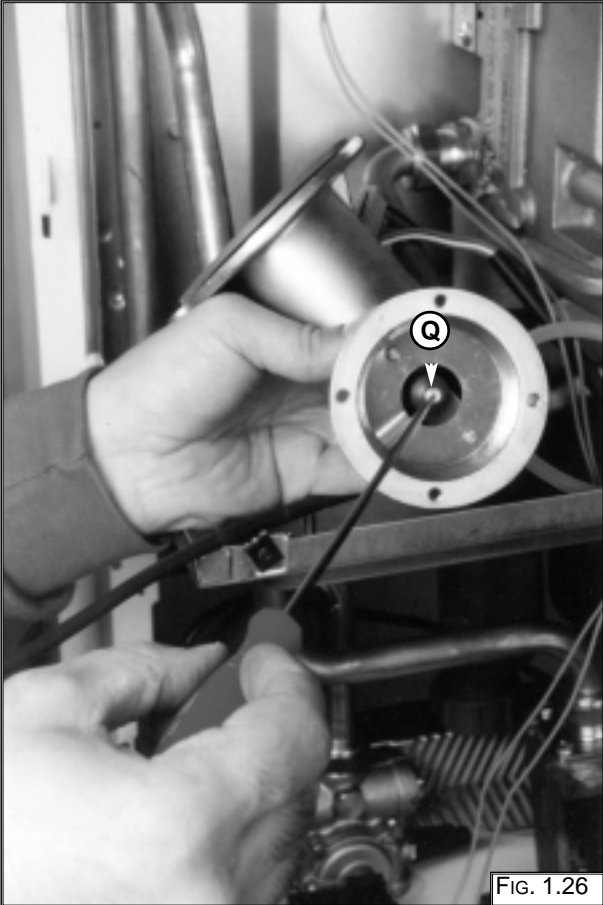


FIG. 1.26

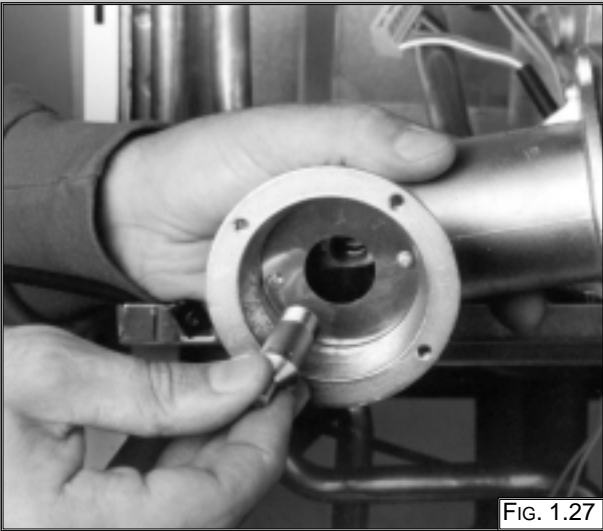
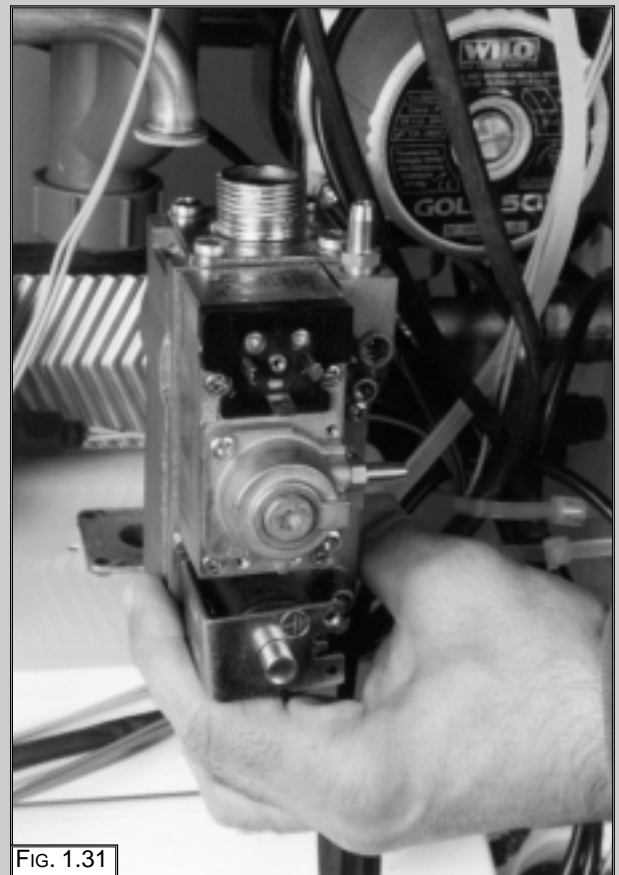
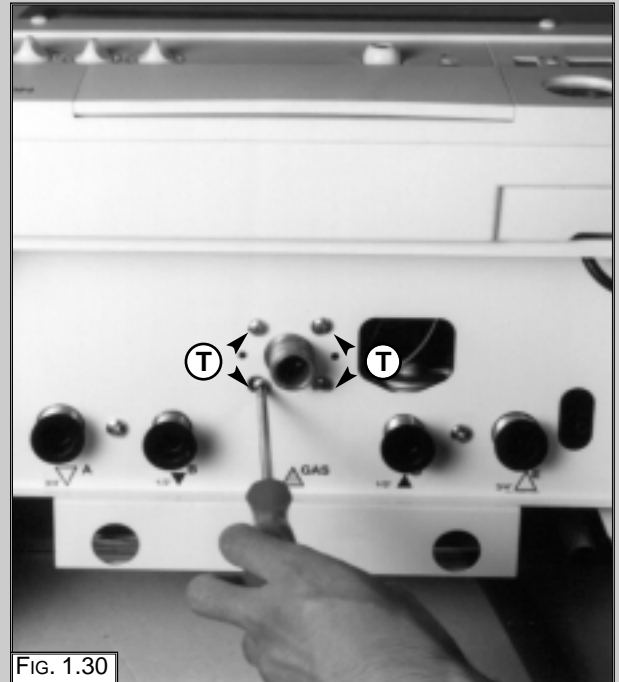
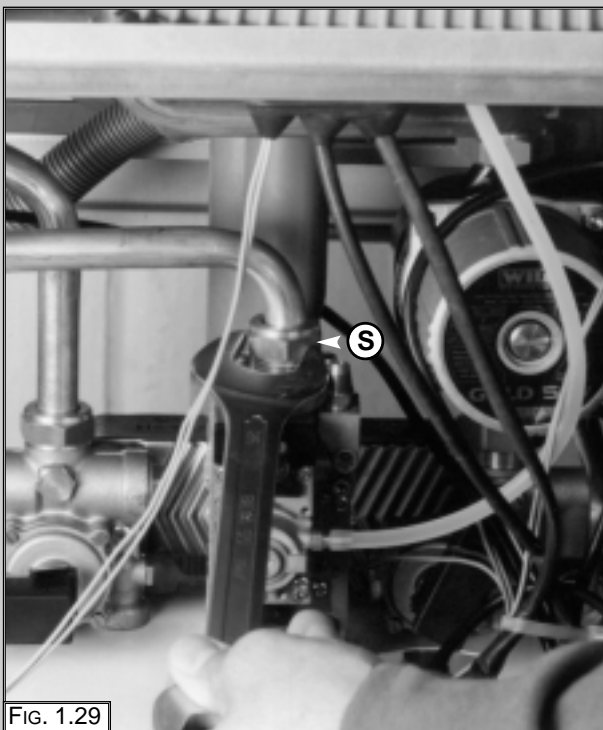
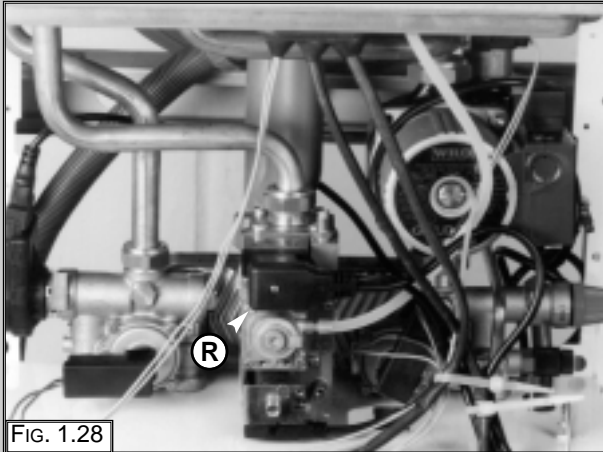


FIG. 1.27

1.4 ACCESS TO THE GAS VALVE

Removing the gas valve

1. Disconnect the electrical connection "R" from the gas valve (FIG. 1.28);
2. Release the top nut "S" (FIG. 1.29);
3. Remove the screws "T" from the bottom of the gas valve pipe (FIG. 1.30);
4. Remove the gas valve (FIG. 1.31).

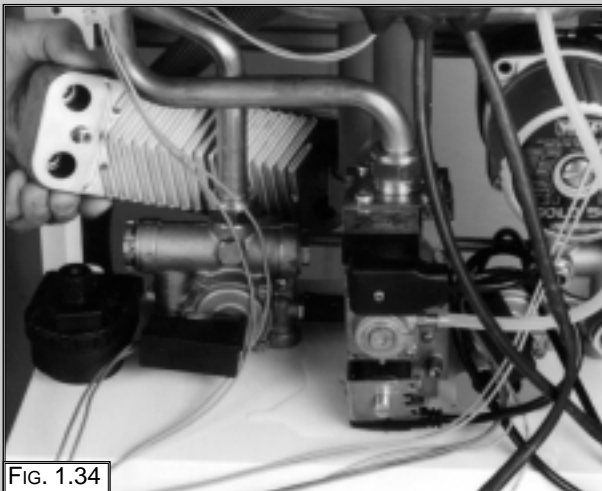
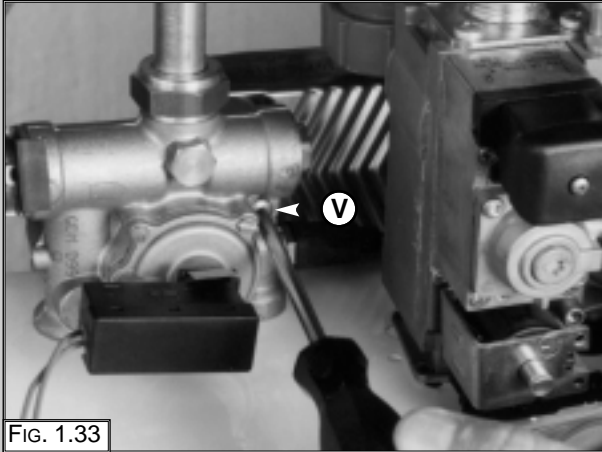
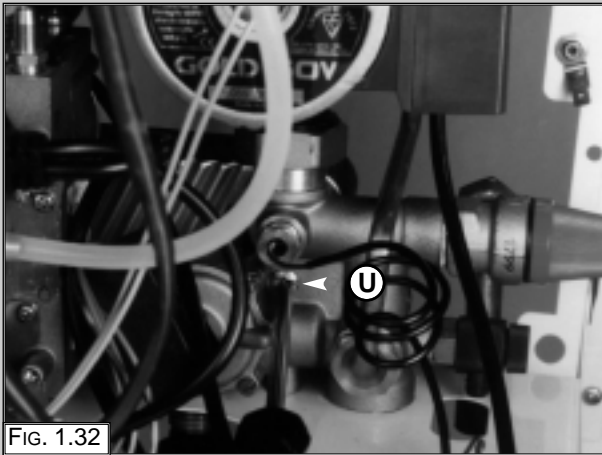


1.5 ACCESS TO THE WATER CIRCUIT

Important! Before any component is removed, the boiler must be drained of all water.

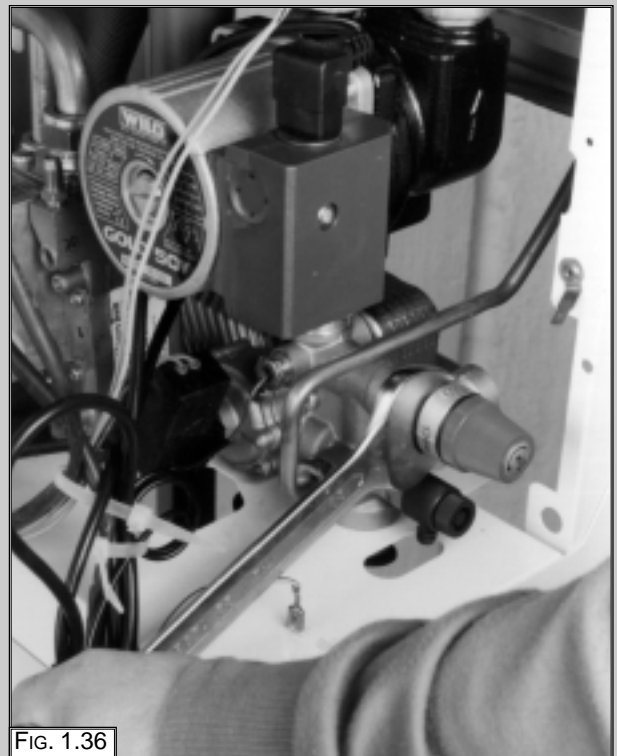
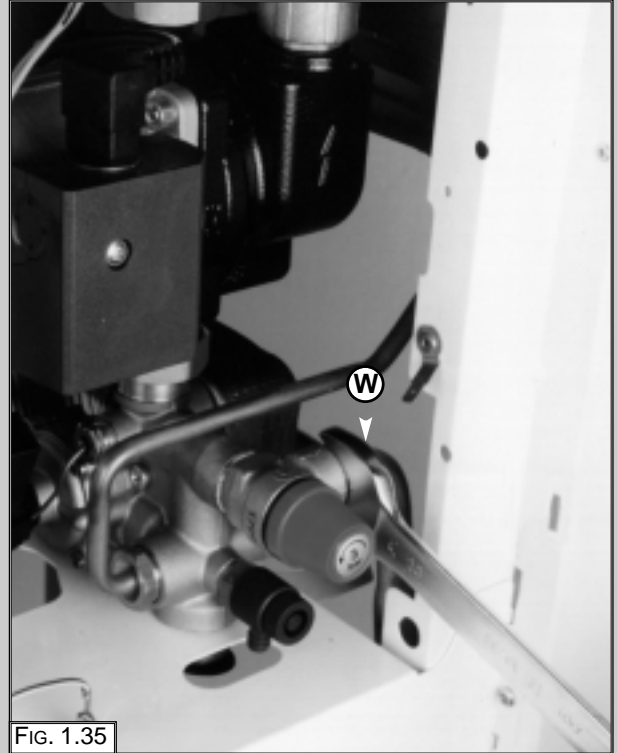
Removing the D.H.W. (secondary) exchanger

1. Remove the screw "U" (FIG. 1.32);
2. Remove the screw "V" (FIG. 1.33);
3. Push the exchanger towards the rear of the boiler, lift upwards and remove from the front of the boiler (FIG. 1.34);
4. Before replacing the exchanger ensure that the O-rings are in good condition and replace if necessary.



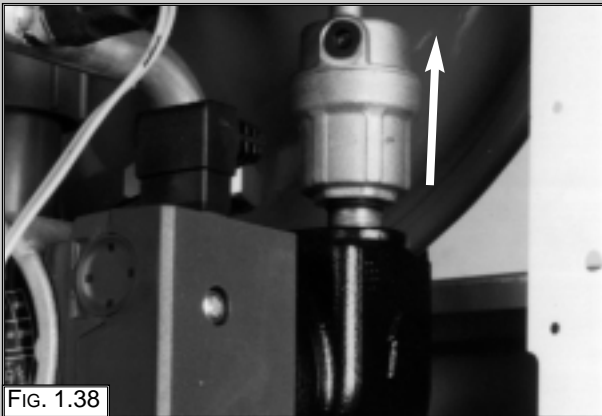
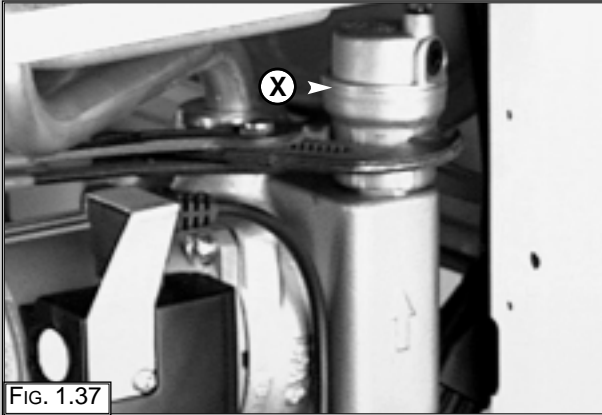
Removing the safety valve

1. Loosen union "W" (FIG. 1.35);
2. Unscrew and remove the valve (FIG. 1.36).



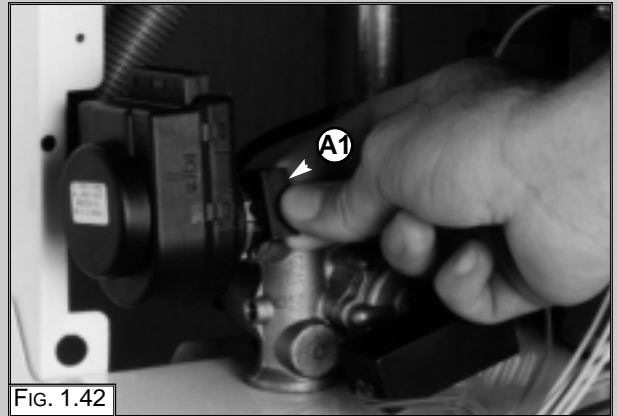
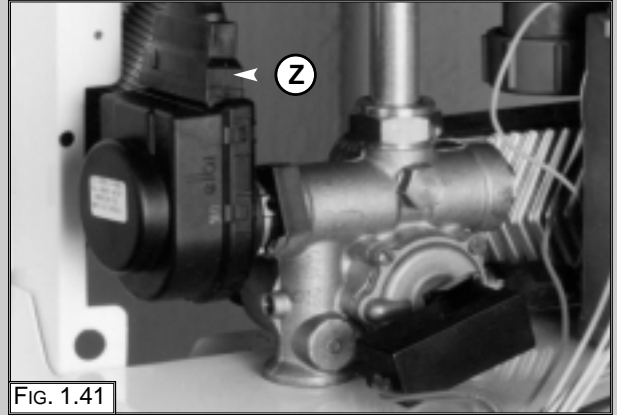
Removing the automatic air vent

1. Unscrew valve "X" (FIG. 1.37);
2. Remove (FIG. 1.38).



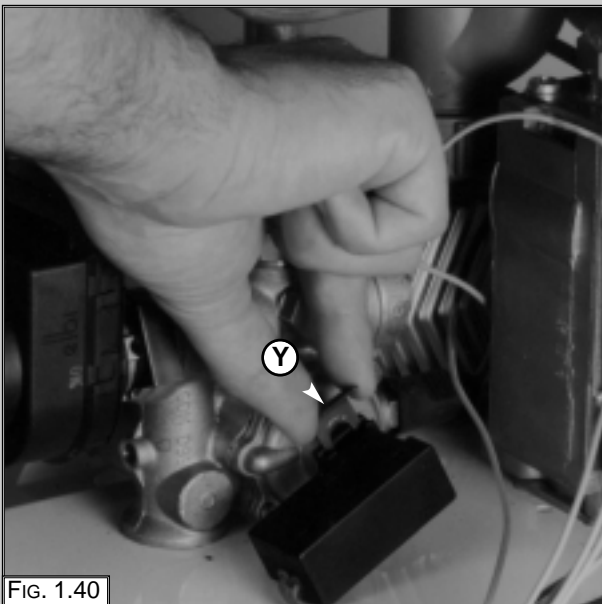
Removing the diverter valve actuator

1. Unplug the electrical connector "Z" (FIG. 1.41);
2. Release the retaining clip "A1" and remove the diverter valve actuator (FIG. 1.42).



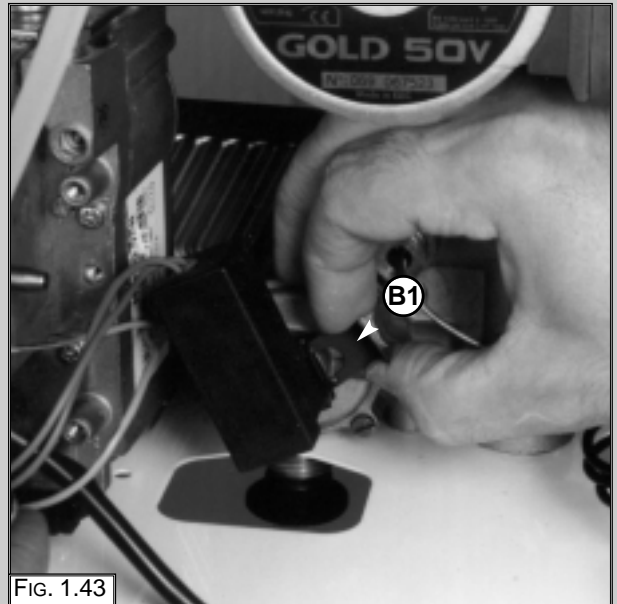
Removing the main circuit flow switch

1. Release the retaining clip "Y" (FIG. 1.40);
2. Remove the main circuit flow switch.



Removing the D.H.W. flow switch

1. Release the retaining clip "B1" (FIG. 1.43);
2. Remove the D.H.W. flow switch.



Removing the pump

1. Unplug the electrical connection "C1" (FIG. 1.44);
2. Release the nut "D1" (FIG. 1.45);
3. Release the nut "E1" (FIG. 1.46);
4. Remove the pump (FIG. 1.47).



FIG. 1.44



FIG. 1.45

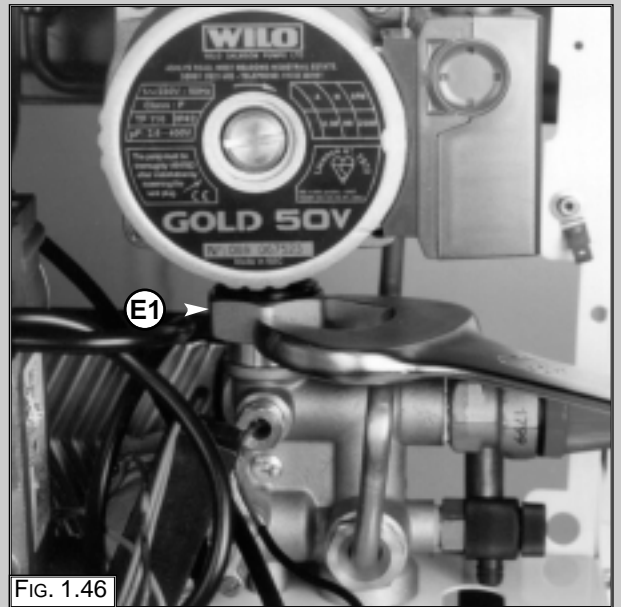


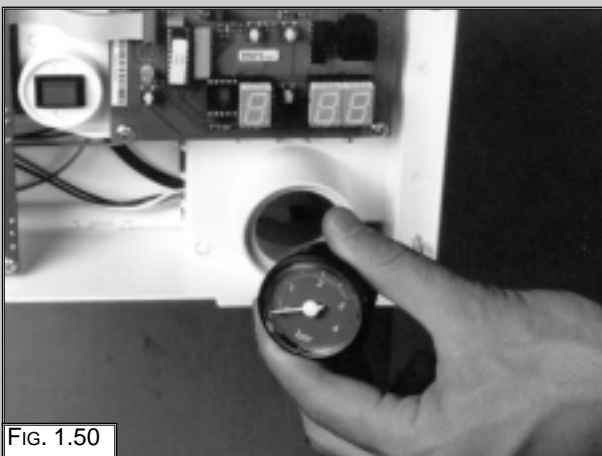
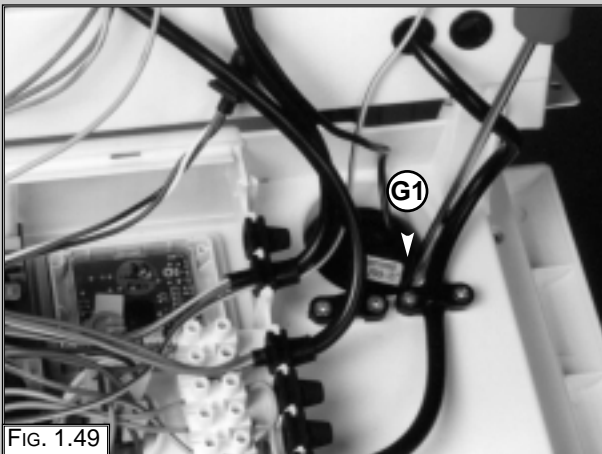
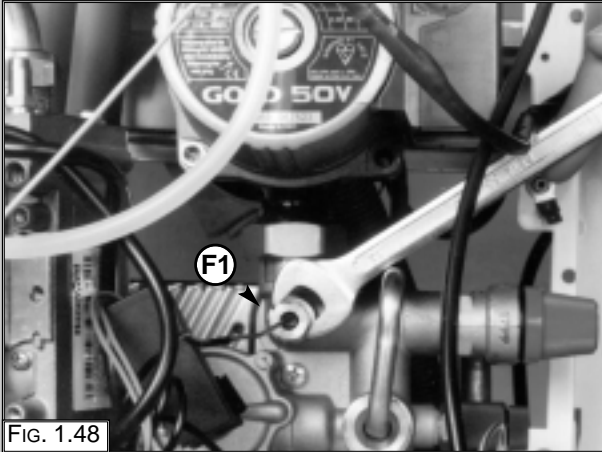
FIG. 1.46



FIG. 1.47

Removing the pressure gauge

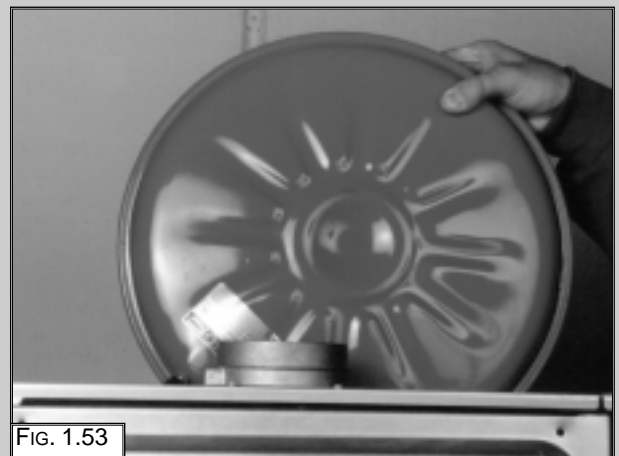
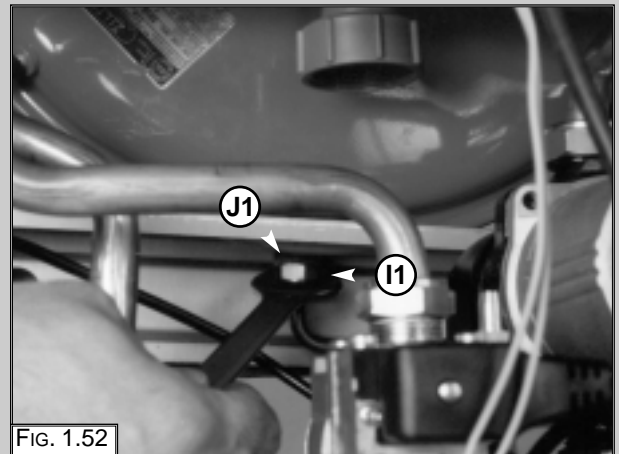
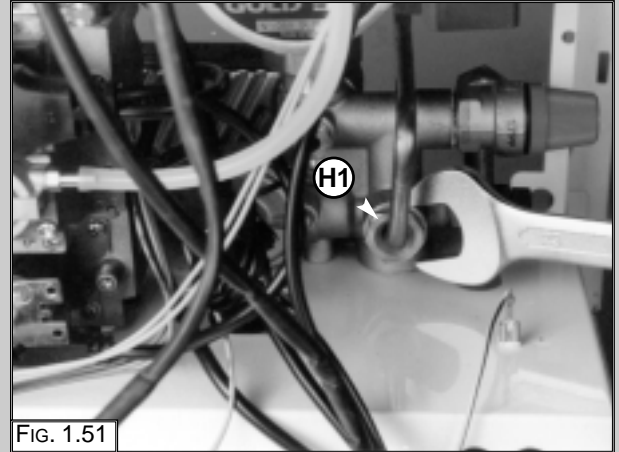
1. Release coupling "F1" (FIG. 1.48);
2. Ease the pressure gauge "G1" through the control panel from the rear (FIG. 1.49);
3. Remove the pressure gauge. (FIG 1.50).



Removing the expansion vessel

See the section on removing the condensate trap before carrying out this procedure

1. Loosen nut "H1" (FIG. 1.51);
2. Loosen nut "I1" and remove backnut "J1" (FIG. 1.52);
3. Remove the expansion vessel (FIG. 1.53).



Removing the D.H.W. temperature probe (N.T.C.) (MFFI only)

1. Remove the electrical connector "K1" by pulling off (Fig. 1.54);
2. Unscrew and remove the D.H.W. temperature probe "L1" (Fig. 1.55).

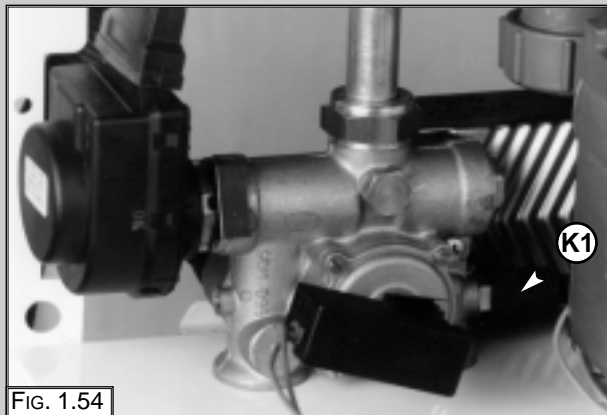


FIG. 1.54

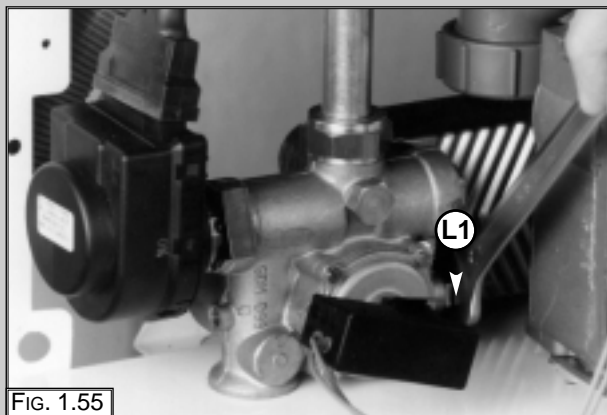


FIG. 1.55

Removing the C.H. flow temperature probe (N.T.C.)

1. Remove the electrical connector "M1" by pulling off (Fig. 1.56);
2. Unscrew and remove the C.H. flow temperature probe "N1" (Fig. 1.57).

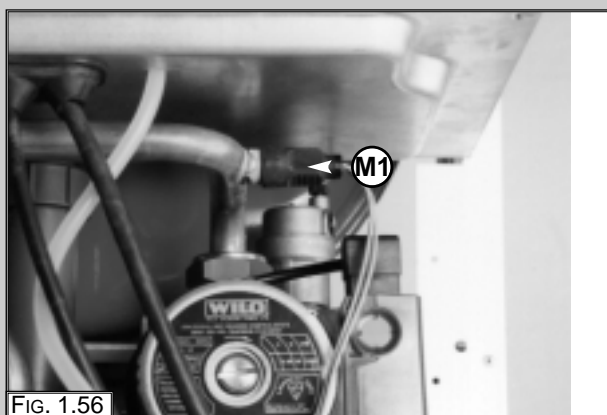


FIG. 1.56

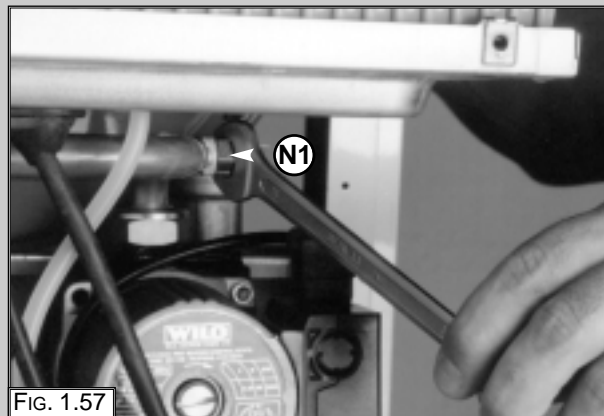


FIG. 1.57

Removing the C.H. return temperature probe (N.T.C.)

1. Remove the electrical connector "O1" by pulling off (Fig. 1.58);
2. Unscrew and remove the C.H. return temperature probe "P1" (Fig. 1.59).

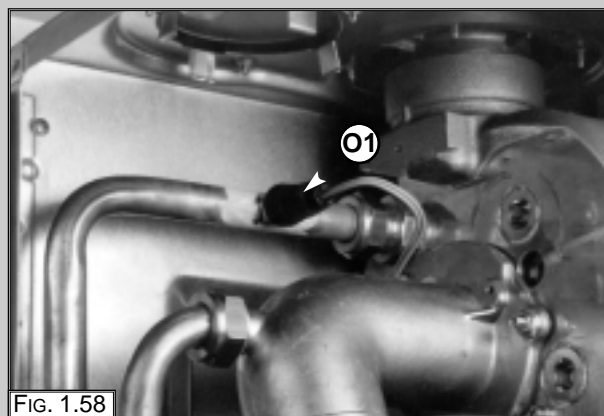


FIG. 1.58

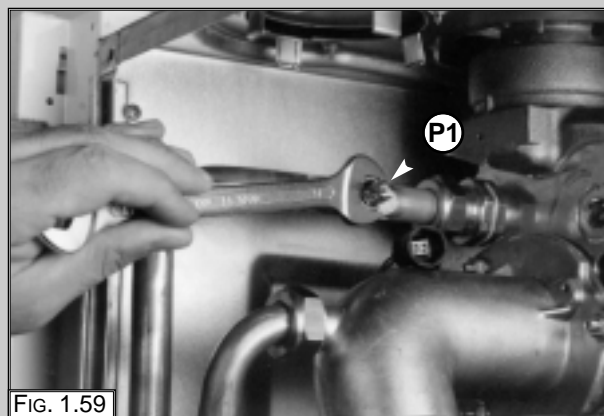
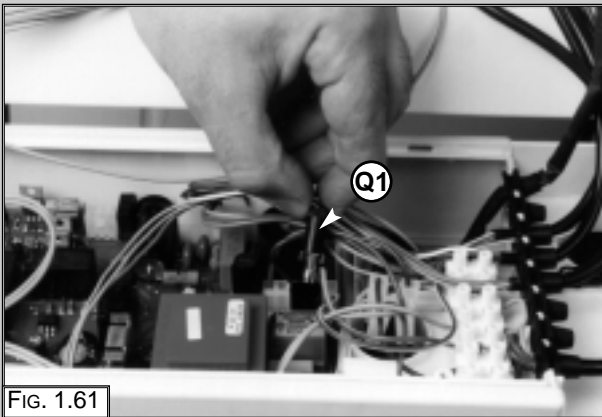
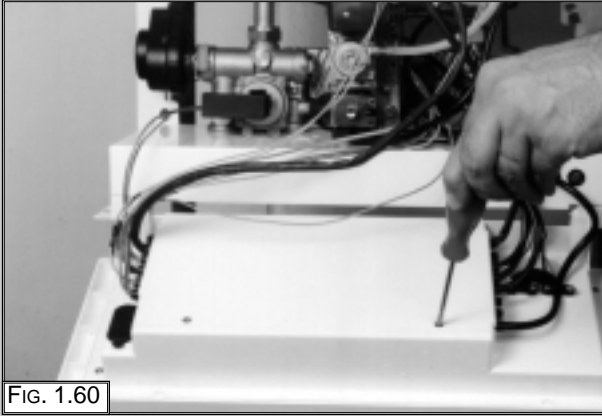


FIG. 1.59

1.6 ACCESS TO THE CONTROL SYSTEM

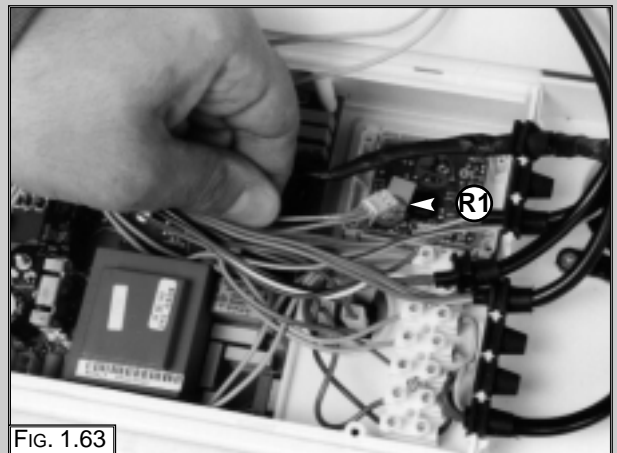
Checking the fuses

1. Remove the inspection cover on the reverse of the control panel (FIG. 1.60);
2. Remove the fuses by pushing and rotating fuse holders "Q1" (FIG. 1.61).



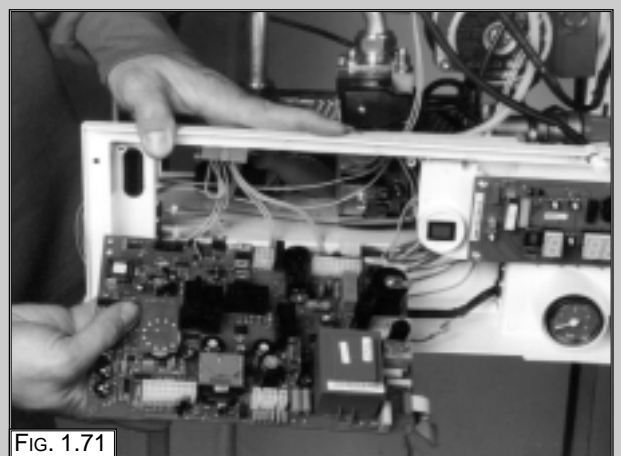
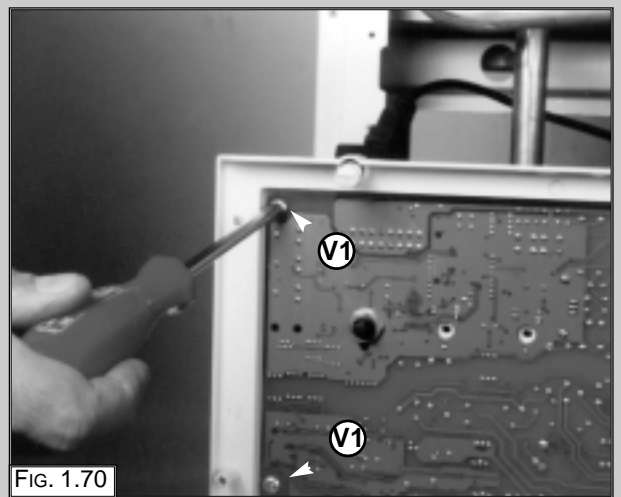
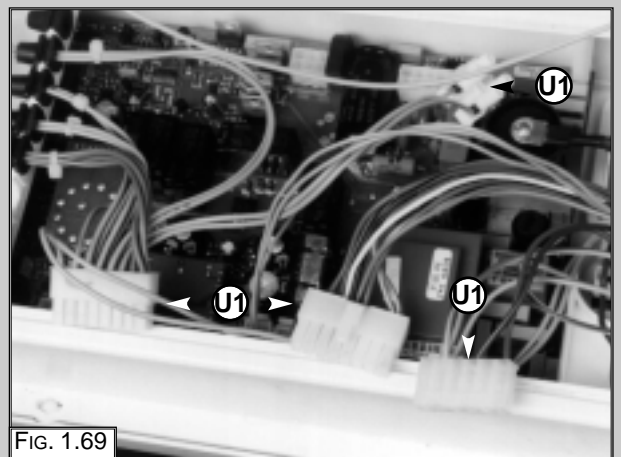
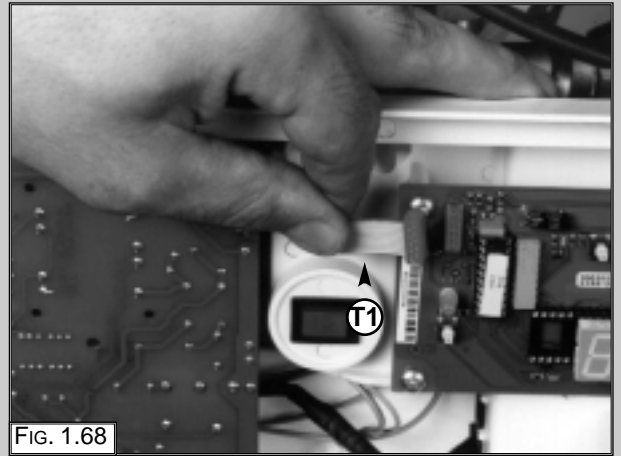
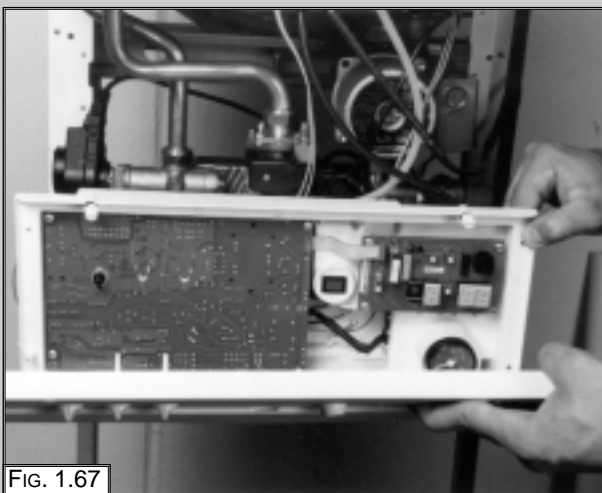
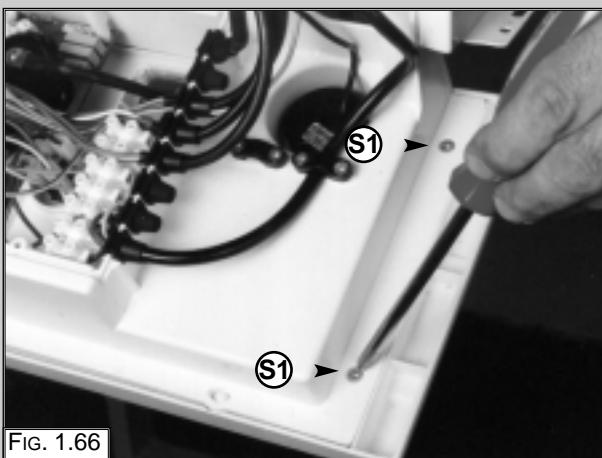
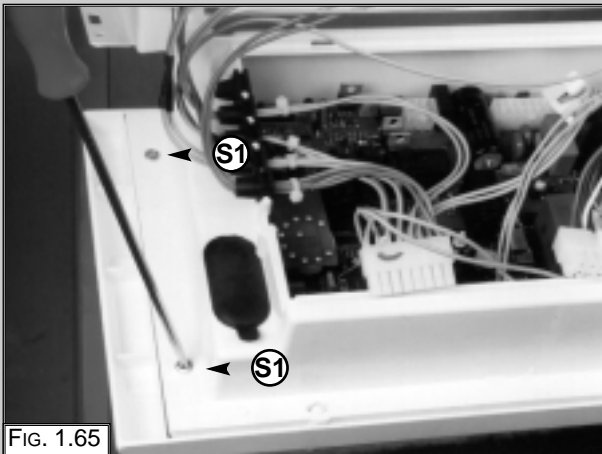
Removing the time clock

1. Remove the inspection cover on the reverse of the control panel (FIG. 1.60);
2. Lower the time clock door (FIG. 1.62);
3. Unplug the electrical connection "R1" from the time clock (FIG. 1.63);
4. Gently squeeze each end of the time clock and push through the control panel (FIG. 1.64).



Removing the P.C.B.s

1. Remove the inspection cover on the reverse of the control panel (FIG. 1.60);
2. Remove the screws "S1" (FIG. 1.65 & FIG. 1.66);
3. Remove the facia panel (FIG. 1.67);
5. Disconnect the connection cable "T1" (FIG. 1.68);
6. Unplug the electrical connectors "U1" from the main P.C.B. (FIG. 1.69);
7. Remove the main P.C.B. mounting screws "V1" (four in total) (FIG. 1.70);
8. Remove the main P.C.B. (FIG. 1.71);
9. Remove the display P.C.B. mounting screws "W1" (FIG. 1.72);
10. Remove the display P.C.B. (FIG. 1.73);
11. Replace either P.C.B. in reverse order.



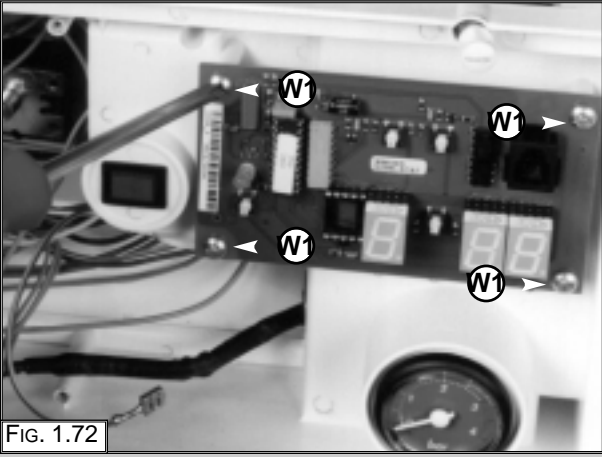


FIG. 1.72

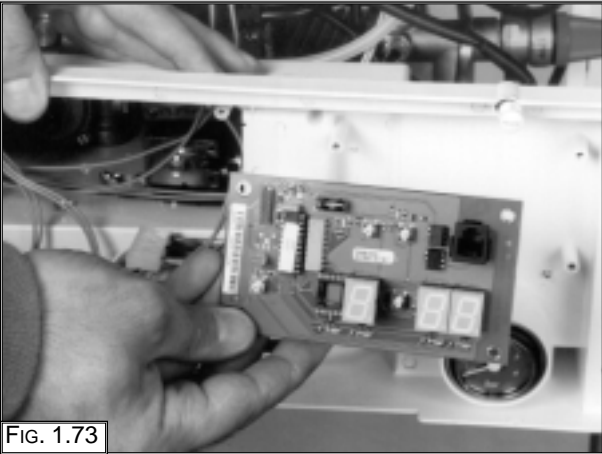


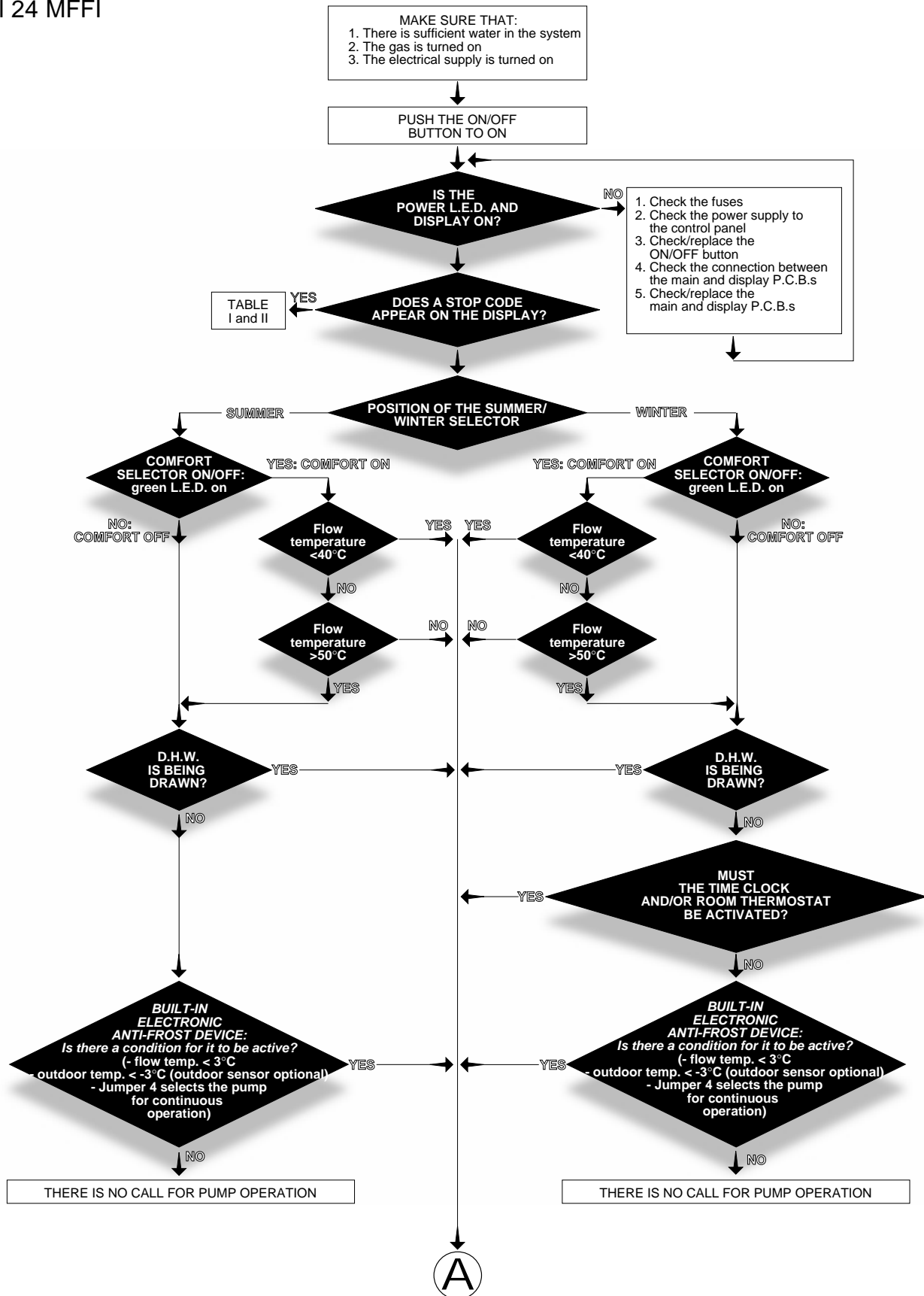
FIG. 1.73

2. FAULT FINDING

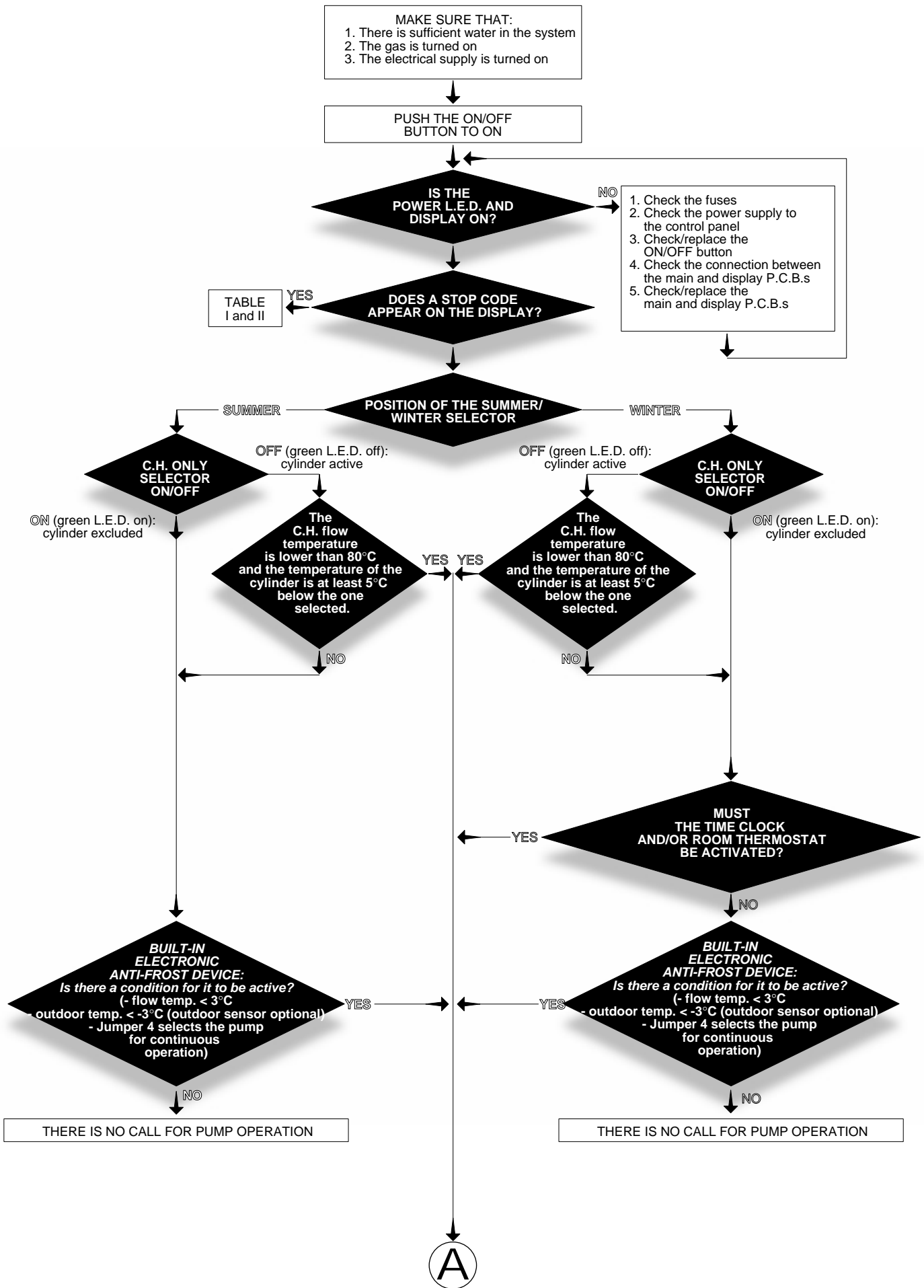
2.1 FAULT FINDING GUIDE (FLOW-CHARTS)

It is possible to detect and correct any defect by using the standard fault finding diagrams described in this chapter.

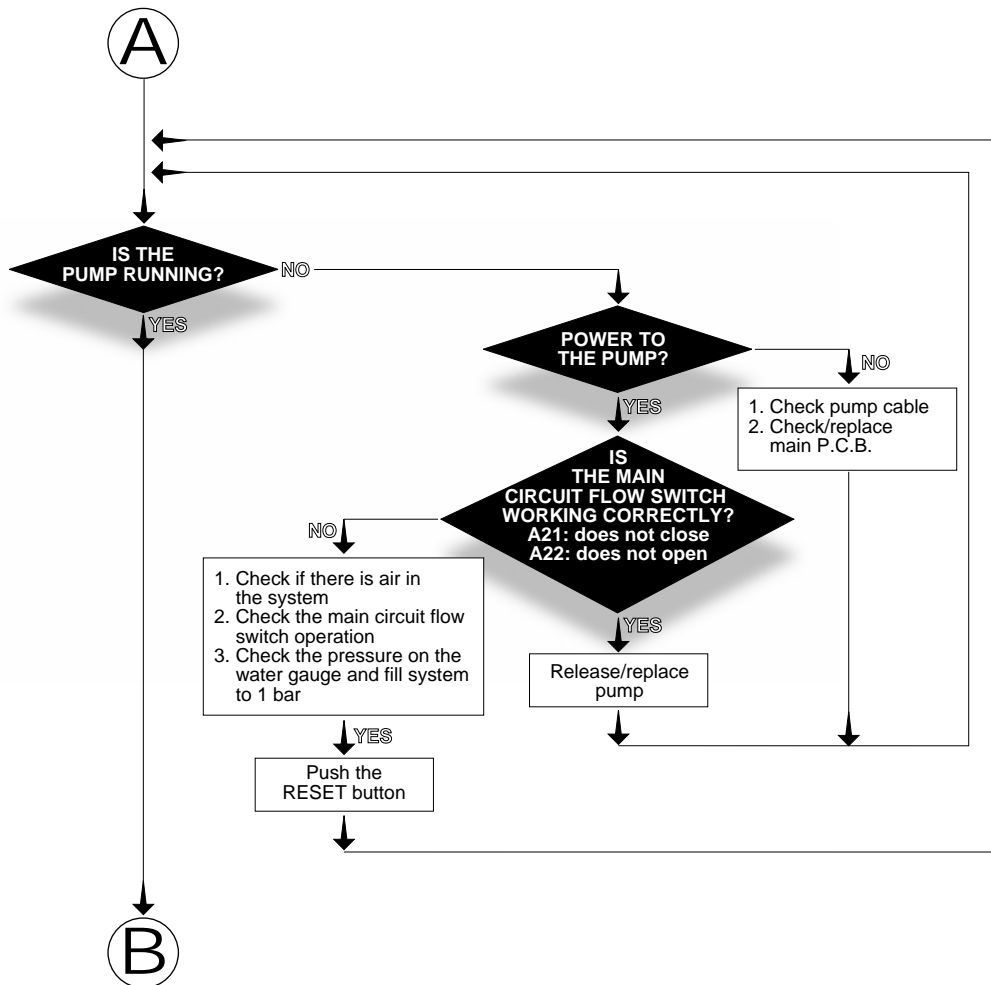
Model 24 MFFI



Model 24 RFFI System



Model 24 MFFI/24RFFI System



Model 24 MFFI/24RFFI System

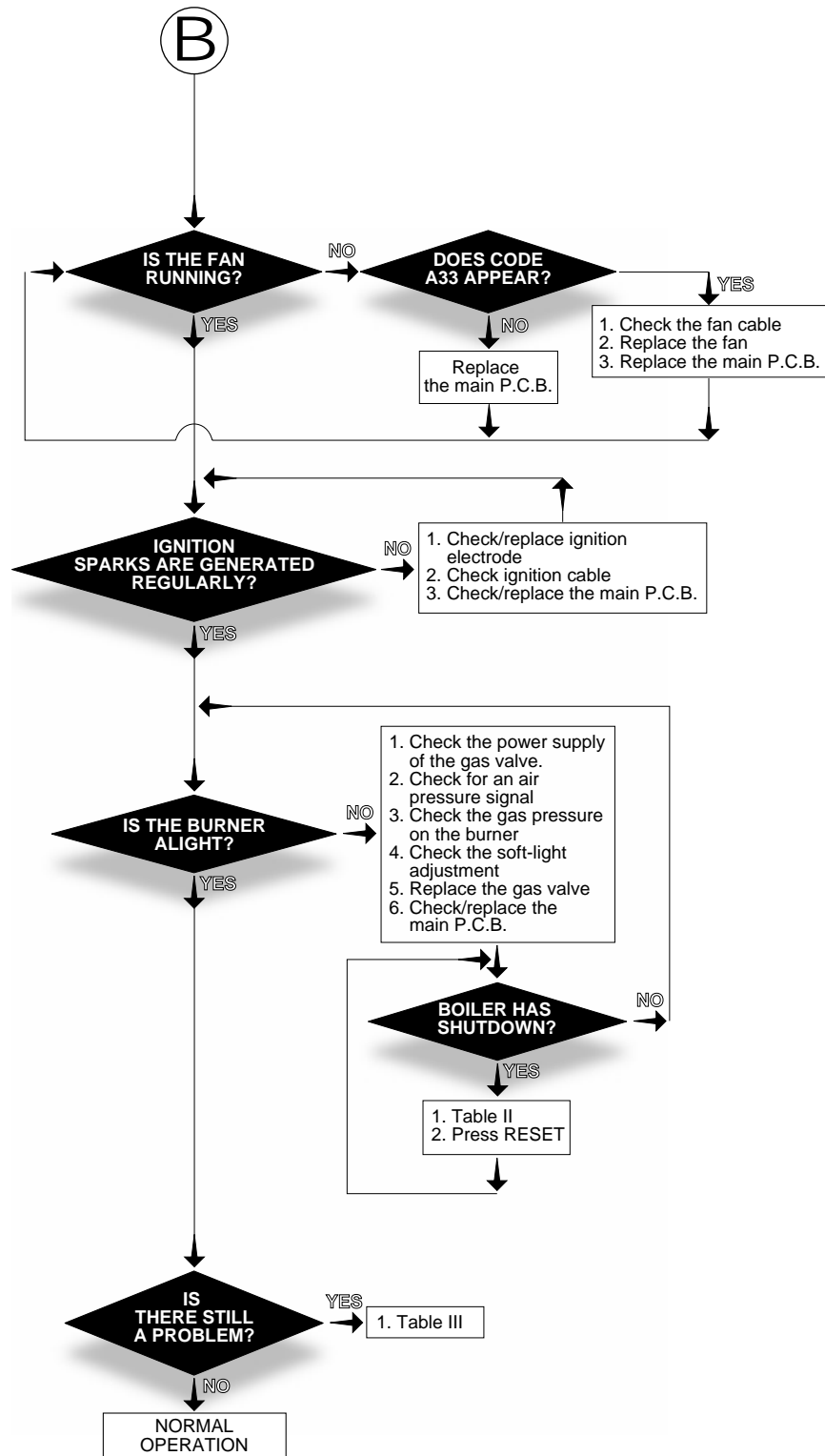


TABLE I	
DISPLAY	CAUSE
A01	Too many attempts to ignite on starting up
A02	After three attempts at ignition, no increase in ΔT was detected
A03	The heating flow temperature exceeds 100°C during operation
A07	Too many failures to flame in one period during operation
A19	The flame was detected after the gas valve had closed
A20	The flame was detected before the gas valve opened
A21	The flow switch does not close
A22	The flow switch does not open
A33	Problem with the fan
A99	Problem with the electronic monitoring

TABLE II	
DISPLAY	CAUSE
E03	Flow temperature over 100°C while boiler is not in operation (stand-by)
E5b	Heating flow temperature probe in open circuit
E6b	Heating flow temperature probe
E04	Domestic hot water temperature probe in open circuit
E05	Domestic hot water temperature probe in short circuit
E08	Under floor heating temperature probe in open circuit
E20	Flame detected with gas valve closed
E21	Error in the electrical connection (live and neutral crossed)
E22	Problem with the 50Hz power supply
E23	Flame detection electrode short-circuited
E64	Heating return temperature probe in open circuit
E74	Heating return temperature probe in short circuit
E99	Problem within the electronic system

TABLE III	
FAULTS	POSSIBLE CAUSES
1. Drawing D.H.W: Radiators heat up in summer mode	- faulty 3-way valve
2. Drawing D.H.W: Insufficient hot water temperature	- check C.H./D.H.W. temperature probes - check gas pressures - check water flow rate - check secondary heat exchanger
3. Drawing D.H.W: Noisy operation	- primary heat exchanger faulty or lime-scale deposits - low heating system water pressure - check gas pressures - check C.H./D.H.W. temperature probes
4. Decrease/increase heating circuit pressure	- check for leaks on the heating circuit - faulty filling-loop - faulty secondary heat exchanger - expansion vessel faulty
5. When cold water tap turned off, the boiler ignites	- drop in pressure in the water mains, with consequent water hammer
6. Insufficient radiator temperature	- check C.H. temperature probe - check by-pass - check gas pressures

3. ELECTRICAL DIAGRAMS

LEGEND:

A: JUMPER

When needed, the P.C.B. allows the different options to be selected by means of a wire link.

The boiler has the following basic arrangement:

- 1 OPEN
- 2 CLOSED (*jumper*)
- 3 OPEN
- 4 OPEN
- 5 OPEN
- 6 OPEN
- 7 CLOSED
- 8 OPEN (*MFFI*); CLOSED (*SYSTEM*)

NOTE: under absolutely no circumstances must jumpers 2, 7 and 8 be removed. The opening of such contacts will lead to boiler malfunction.

This is the factory configuration. It is recommended that this set-up not be changed, unless under the following particular circumstances:

JUMPER 3: if the contact is closed, the Secondary Output (flying clamp connected to connection C7; positions 1-9) controls a LPG valve (optional).

JUMPER 4: if the contact is closed, the continuous operation of the pump is selected. If the contact remains open, it has no effect and there is no change in the operation of the boiler.

JUMPER 5: if the contact is closed, the signal transmitted by the connection of the secondary output clasp (connected to C7; positions 1-9) relates to a secondary pump (optional). If the contact remains open, the output signal controls a zone valve (optional).

JUMPER 6: not used

JUMPER 7/8:

7	8	CONFIGURATION
N.I.	N.I.	Central heating only
I.	N.I.	MFFI
N.I.	I.	Not used
I.	I.	RFFI System

I = inserted (contact closed)
N.I = not inserted (contact open)

NOTE: it is essential that the operations involving setting of the jumpers be carried out only with the device turned off.

B: Control microprocessor

C: Flame detection jumper (under no circumstances should this jumper be moved from the 1-2 position)

D: Anti-cycling device (RA)

E: Maximum heating output regulation (PR)

F: Soft-light regulation (RLA)

G: Operating mode selector knob

H: Heating temperature adjustment

I: Domestic hot water temperature adjustment

J: Remote control module

K: Main microprocessor

L: Relay

M: Fuses (2 x 0.54 A SLOW)

N: Transformer (PRI: 230V-50Hz; SEK: 10V-0,8VA; SEK:10V-3,5VA; SEK:10V-3,5VA;)

O: Fuses (2 x 3.15 A SLOW)

P: Earth

Q: Spark generator

R: Connection to the main P.C.B.

S: Comfort light

T: Programming keys

U: Comfort key

V: Alpha-numeric display

X: Set and reset key

W: Connection to PC

C1 = FAN

- 1: "Hall" sensor power supply 12V (red)
- 2: "Hall" sensor ground (blue)
- 3: Not used
- 4: Start of coil (black)
- 5: "Hall" sensor input (white)
- 6: End of coil (brown)

C2 = POWER SUPPLY

- 1: Earth (yellow/green)
- 2: Earth (yellow/green)
- 3: Not connected
- 4: Neutral (blue)
- 5: Not connected
- 6: Live (brown)

C3 = CONNECTION TO ROOMSTAT

- 1: Input - 1
- 2: Input - 2

C4 = TIMER

- 1: 3 V output
- 2: Timer ground
- 3: Timer output
- 4: Not connected

C5 = REMOTE CONTROL (Bus+/Bus-)

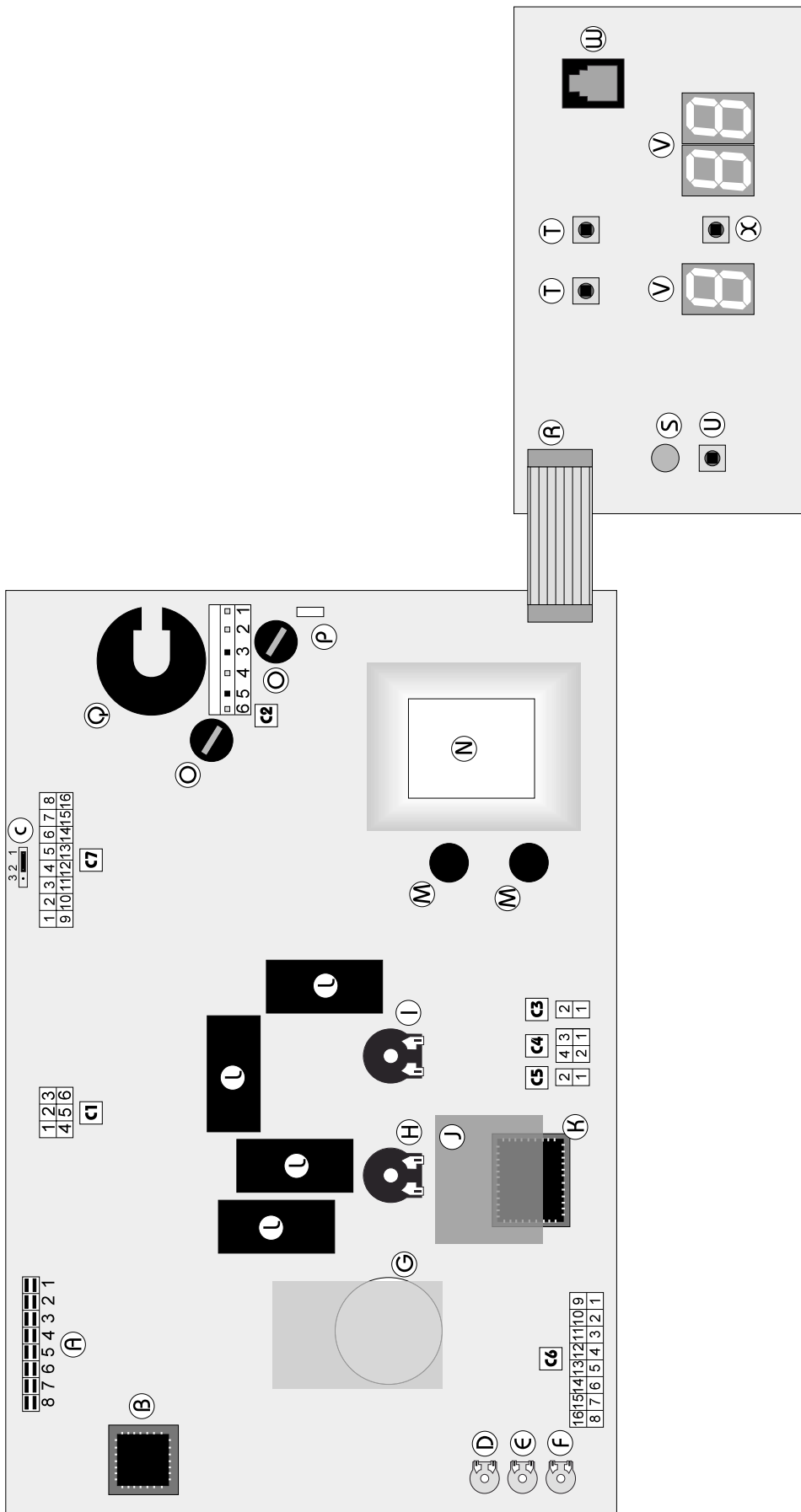
- 1: Input/output-1
- 2: Input/output-2

C6 = SENSOR CONNECTOR

- 1: Domestic hot water flow switch (grey)
- 2: Main circuit flow switch (grey)
- 3: Under floor heating thermostat (grey)
- 4: Heating flow sensor (grey)
- 5: Heating return sensor (grey)
- 6: Domestic hot water sensor (grey)
- 7: Not used: jumper
- 8: Outdoor sensor (grey)
- 9: Domestic hot water flow switch (grey)
- 10: Main circuit flow switch (grey)
- 11: Under floor heating thermostat (grey)
- 12: Flow sensor (grey)
- 13: Heating sensor (grey)
- 14: Domestic hot water sensor (grey)
- 15: Not used: under floor heating
- 16: Outdoor sensor (grey)

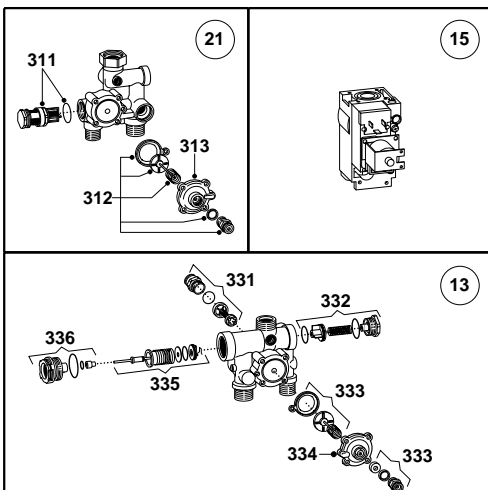
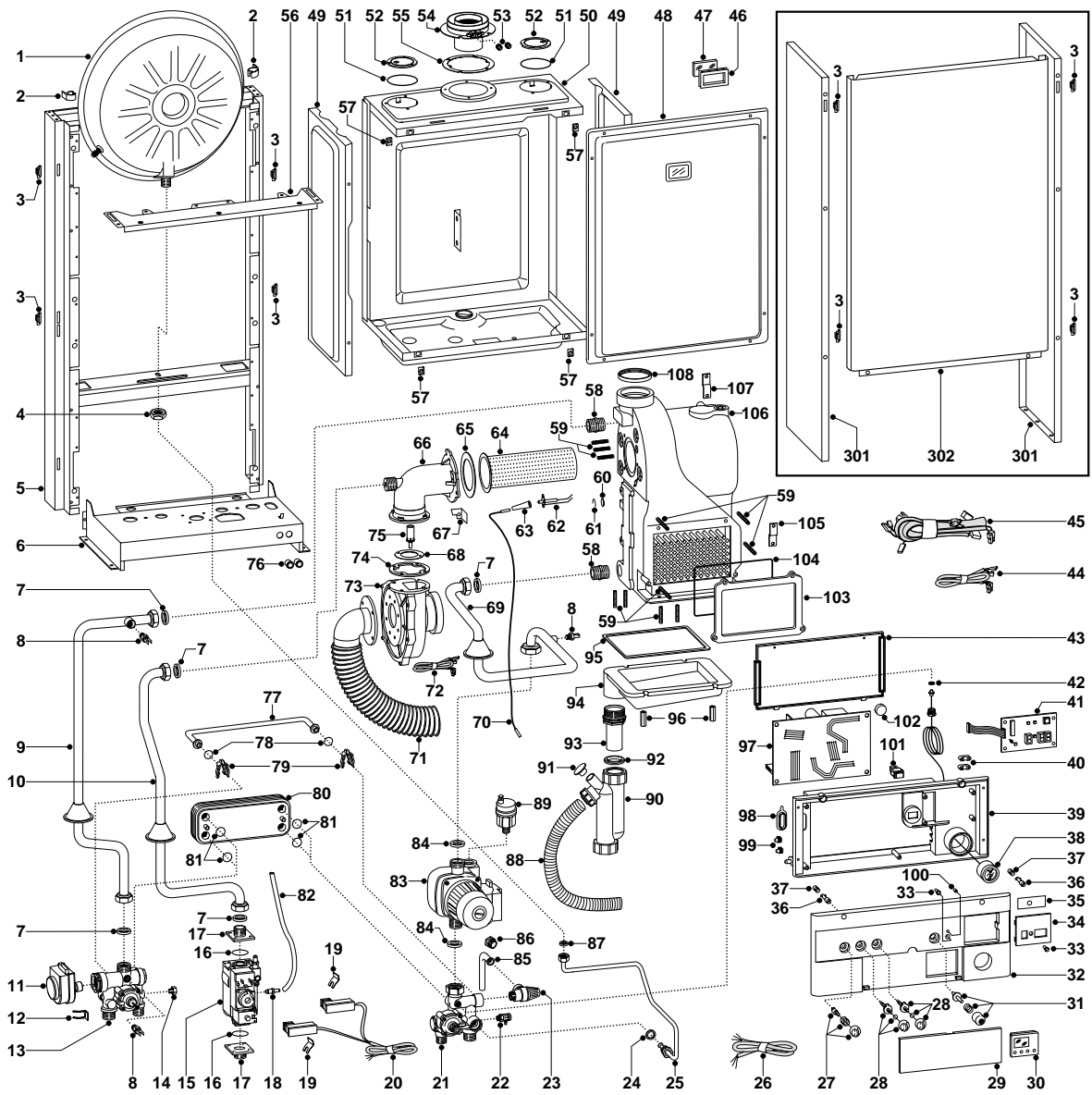
C7 = EQUIPMENT CONNECTIONS

- 1: Secondary output (optional)
- 2: Gas valve (white)
- 3: 3-way valve neutral (white)
- 4: Pump (white)
- 5: Ionisation (black)
- 6: Not connected
- 7: Ground
- 8: Pump earth (yellow/green)
- 9: Secondary output (optional)
- 10: Gas valve (brown)
- 11: 3-way valve (domestic hot water) (brown)
- 12: 3-way valve (heating) (brown)
- 13: Pump (brown)
- 14: Not connected
- 15: Earth
- 16: Gas valve earth (yellow/green)

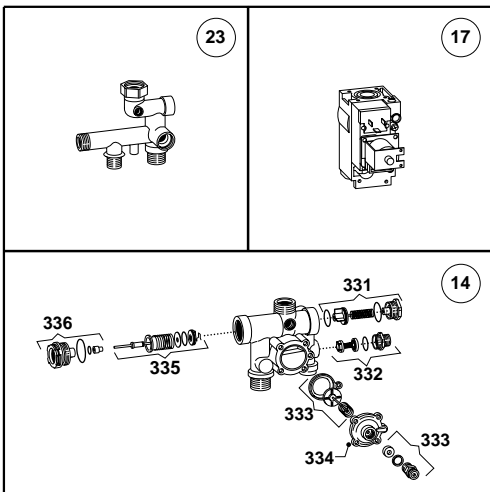
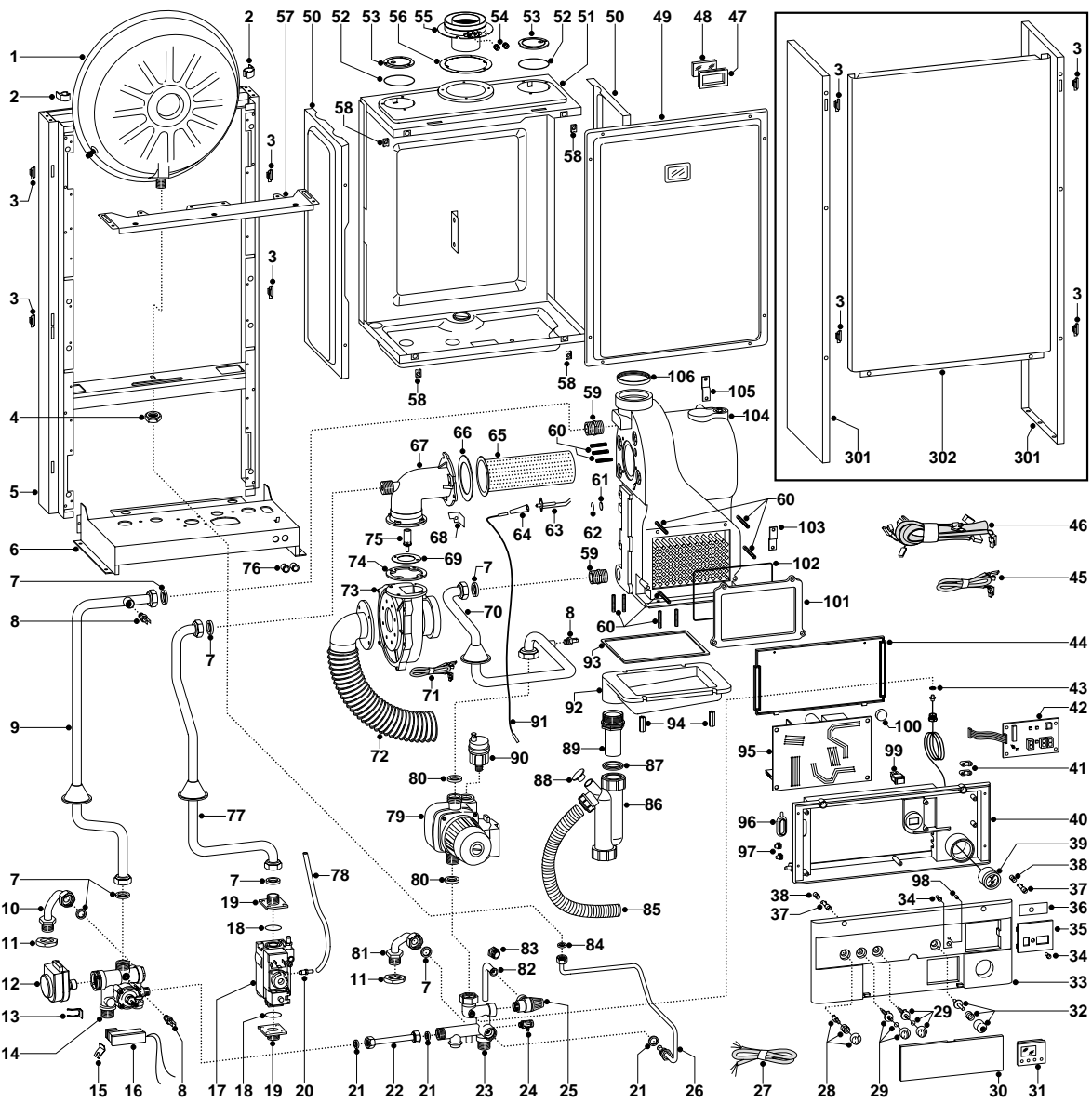


4. SHORT SPARE PARTS LIST

ecoGENUS - 24 MFFI



ecoGENUS - 24 RFFI SYSTEM



ecoGENUS - 24 RFFI SYSTEM

Key no.	G.C. part no.	Description	ARISTON Part No.
1	E25 417	Expansion vessel	573294
7	164 225	Gasket 3/4"	573520
8	164 338	Temperature probe (C.H.W.)	569236
12	E25 427	Motor (3- Way valve)	997147
13	E25 429	Fixing clip (motor)	997077
14		Flow group	998456
17		Gas valve	571438
21	164 229	Gasket 1/2"	573528
23		Return group	997828
24	378 814	Manual vent cock	573727
25	E26 378	Safety valve 1/2" 3 bar	573172
31	E26 819	Time clock	997207
39	E25 437	Pressure gauge	571649
42		P.C.B. (display)	998765
43	164 261	Gasket 1/4"	569390
63		Electrode (ignition/detection)	998672
65		Burner	998668
71		Fan cable & sensor	998889
73		Fan	998888
75A		Injector (G20)	998651
75B		Injector (G30)	998783
79	E25 518	Pump	997151
80	164 230	Gasket 1"	569387
84	164 282	Gasket 3/8"	573521
86		Condensate Trap	998791
87		Gasket (airtight - condensate trap)	573768
88		Cap (trap filling)	998792
90	379 079	Auto air vent	564254
91		Electrode cable (resistive)	998459
95		P.C.B. (main)	998801
104		Main exchanger (aluminium)	998670
331		D.H.W. pressure switch kit	571987
332		Central heating by-pass kit	571443
333		Heating pressure switch kit	571441
334		Pressure cover	574248
335	E24 077	3-way spring kit	571447
336		Heating actuator bush	998013

Manufacturer: **Merloni TermoSanitari SpA - Italy**

Commercial subsidiary: **MTS (GB) LIMITED**

MTS Building
Hughenden Avenue
High Wycombe
Bucks HP13 5FT

Telephone: (01494) 755600

Fax: (01494) 459775

Internet: <http://www.mtsgb.ltd.uk>

E-mail: info@mtsgb.ltd.uk

Technical Service Hot Line: (01494) 539579



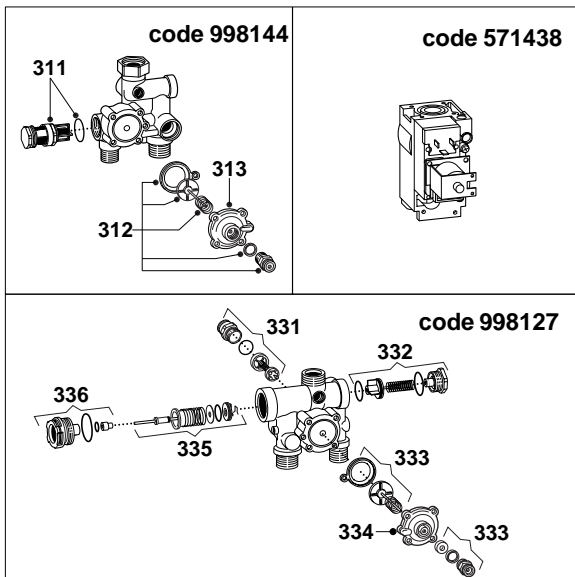
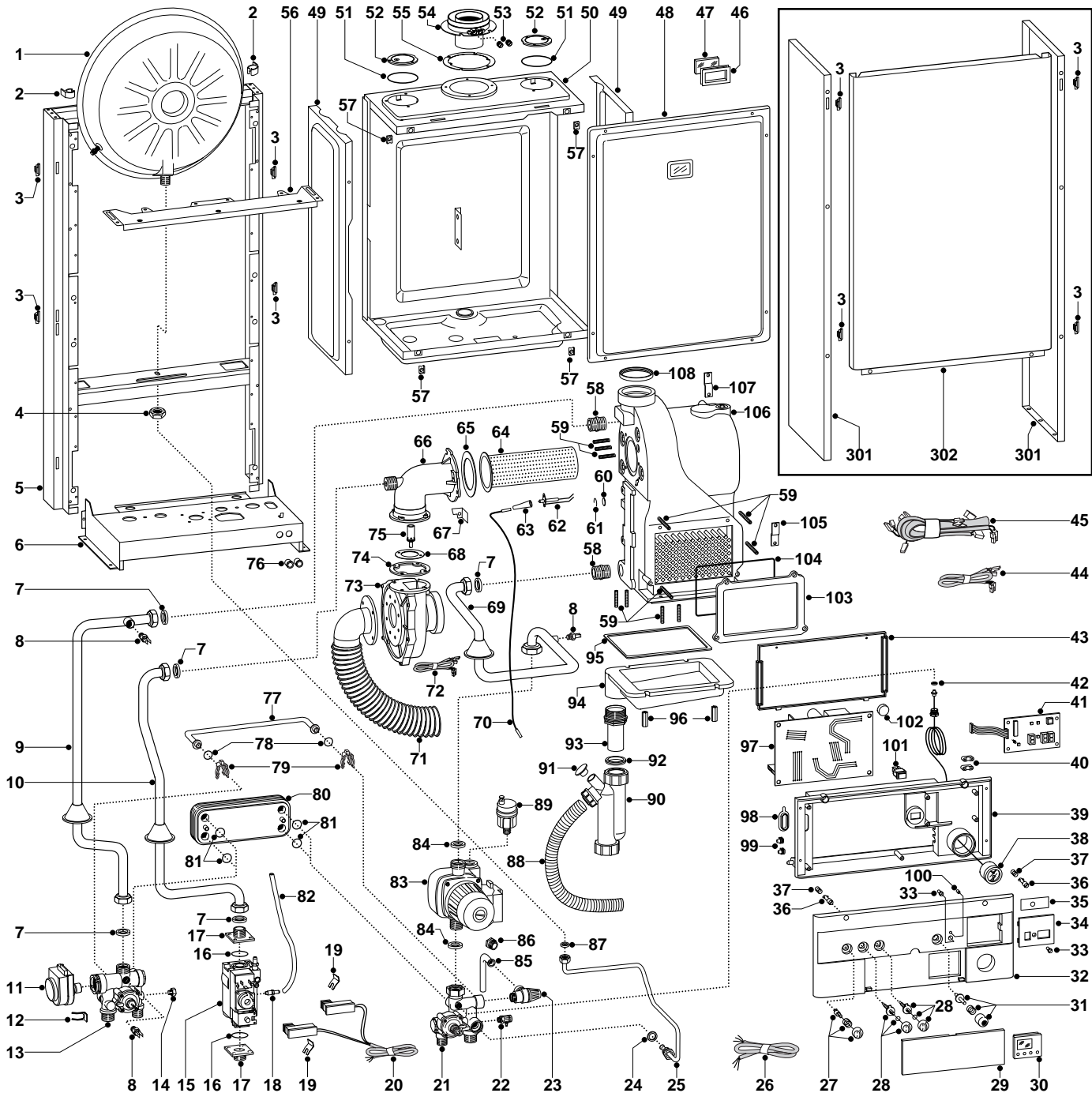
SPARE PARTS EXPLODED VIEW
GAS WALL BOILERS

Models

ECOGENUS 24 MFFI

Edition 1 of 1 December 1999





MODELS	CHARACTERISTICS	SERIAL NO: VALIDITY	REF.
ECOGENUS 24 MFFI	METHANE	9933500098	A

PART.	CODE	DESCRIPTION	REF.	NOTE
1	573294	Expansion vessel		
2	573310	Expansion vessel insert		
3	574302	Casing support bracket (Plastic)		
4	573244	3/8" lock nut		
5	-----	Frame		11
6	-----	Hydraulic group support		11
7	573520	Gasket 3/4"		
8	569236	Temperature probe (C.H.W.)		
9	998655	Pipe (C.H. flow)		
10	998656	Pipe (gas valve/burner jet)		
11	997147	Motor (3-Way valve)		
12	997077	Fixing clip (motor)		
13	998127	Flow group		
14	570615	1/8" Brass plug		
15	571438	Gas valve		
16	565048	O-ring gasket (gas valve)		
17	998665	Union (gas valve)		
18	573793	Intake (pressure - control valve)		
19	573824	Bracket (M/Flow Micro Switch)		
20	998802	Micro switch set (main flow & D.H.W.)		
21	998144	Return group		
22	573727	Manual vent cock		
23	573172	Safety valve (1/2" 3 bar)		
24	573528	Gasket 1/2"		
25	573311	Pipe (expansion vessel)		
26	998674	Wiring (power supply)		
27	573302	Summer/Winter selector kit		
28	998747	Control knob kit		
29	998661	Door (instruction/time clock)		
30	997207	Time clock		
31	998772	On/off push button kit		
32	998778	Control panel (front)		
33	998751	Button (reset)		
34	999073	Cover (display)		
35	998766	Film (display)		
36	998381	Pin (front cover)		
37	998739	Fixing spring (front cover)		
38	571649	Pressure gauge		
39	-----	Control panel		11
40	571562	Cable clamp		
41	998765	P.C.B. (display)		
42	569390	Gasket 1/4"		
43	-----	Cover (connectors)		11
44	999060	Low voltage wiring		
45	998676	High voltage wiring		
46	998076	View window glass gasket		
47	998075	View window glass		
48	574104	Panel (sealed chamber - front)		
49	573247	Panel (sealed chamber - side)		
50	-----	Sealed chamber		11
51	573865	Flue gasket		
52	573330	Air return cover		
53	573326	Flue intake plug		
54	998474	Flue exhaust manifold / header		
55	573337	Gasket (flue manifold)		
56	572984	Casing support bracket		
57	570717	Spring (fastening)		
58	998666	Nipple (gas - 3/4" M/M)		
59	998785	Dowel (M6x35)		
60	998782	View window glass		
61	998775	Retaining ring (D=16mm)		
62	998672	Electrode (Ignition/Detection)		
63	998767	Cap (electrodes)		
64	998668	Burner		
65	998680	Gasket (elbow)		

PART.	CODE	DESCRIPTION	REF.	NOTE
66	998788	Elbow (fan)		
67	-----	Flame mirror		11
68	998786	Diaphragm (condensing boiler)		
69	998654	Pipe (C.H. return)		
70	998459	Electrode cable (resistive)		
71	999071	Pipe (fan suction silencer)		
72	998889	Fan cable & sensor		
73	998888	Fan		
74	998681	Gasket (fan inlet)		
75	998651	Injector (G20)		
76	570772	Cable holder		
77	998065	By-pass pipe		
78	998077	O-ring gasket		
79	998064	Spring (by-pass pipe)		
80	573295	Secondary exchanger (p-type 27kW)		
81	573825	O-Ring (secondary exchanger)		
82	573576	Compensation tube		
83	997151	Pump		
84	569387	Gasket 1"		
85	998019	Pipe (safety valve outlet)		
86	998567	Safety valve outlet pipe ring nut		
87	573521	Gasket 3/8"		
88	998413	Pipe (condensate - plastic)		
89	564254	Auto air vent		
90	998791	Condensate Trap		
91	998792	Cap (trap filling)		
92	573768	Gasket (airtight - condensate trap)		
93	998412	Pipe (drain - plastic)		
94	998787	Condensate tray (aluminium)		
95	998808	Gasket (adhesive - 10x5 mm)		
96	998784	Fixing nut (tray rear)		
97	998801	P.C.B. (main)		
98	998382	Grommet (regulation access)		
99	569720	Blind grommet		
100	998653	L.E.D. lens		
101	569424	On/off neon switch		
102	998460	Gasket (igniter insulation)		
103	998777	Aluminium inspection lid		
104	573766	Front cover gasket		
105	-----	Bottom fixing bracket		11
106	998670	Main exchanger (aluminium)		
107	-----	Top fixing bracket		11
108	998423	Lip gasket (D=66 mm)		
301	998414	Case panel (side)		
302	998478	Case panel (front)		
311	571444	D.H.W. actuator Kit		
312	571441	Heating pressure switch kit		
313	574248	Pressure cover		
331	998490	Central heating by-pass kit		
332	571987	D.H.W. pressure switch kit		
333	571441	Heating pressure switch kit		
334	574248	Pressure cover		
335	571447	3-Way spring kit		
336	998013	Heating actuator bush		

NOTE	DESCRIPTION
11	Not supplied as a spare part