

## CIAO S 20 - 24 C.S.I. CIAO S 24 R.S.I.



**EN** Installation and User Manual

**FR** Manuel d'Utilisation et d'Installation

**ES** Manual de Instalación y Uso

**PT** Manual Usuário e Instalação

**SRB** Priručnik za Montažu i Korišćenje

**TR** Kurulum ve Kullanım Kılavuzu

**EN**

**Ciao S** complies with the basic requirements of the following Directives:

- Gas Appliance Directive 2009/142/EEC;
- Efficiency Directive 92/42/EEC;
- Electromagnetic Compatibility Directive 2004/108/EEC;
- Low Voltage Directive 2006/95/EEC

**EN**

Installer manual-User manual.....	3-10
Technical data.....	12
Control panel.....	69
Appliance functional elements.....	70
Hydraulic circuit.....	72
Wiring diagrams.....	75
Circulator residual head.....	79

**F**

**Ciao S** est conforme aux prescriptions essentielles des Directives suivantes:

- Directive Gaz 2009/142/CEE;
  - Directive Rendements 92/42/CEE;
  - Directive Compatibilité électromagnétique 2004/108/CEE;
  - Directive Basse tension 2006/95/CEE,
- et peut donc être estampillée CE.

**F**

Manuel d'installation-Manuel de l'utilisateur.....	14-21
Données techniques.....	23
Panneau de commande.....	69
Éléments fonctionnels de la chaudière.....	70
Circuit hydraulique.....	72
Schémas électriques.....	75
Prévalence résiduelle du circulateur.....	79

**ES**

**Ciao S** es conforme a los requisitos esenciales de las siguientes Directivas:

- Directiva Gas 2009/142/CEE;
- Directiva Rendimientos 92/42/CEE;
- Directiva Compatibilidad Electromagnética 2004/108/CEE;
- Directiva baja tensión 2006/95/CEE

**ES**

Manual para el instalador - Manual para el usuario.....	25-32
Datos técnicos.....	34
Panel de mandos.....	69
Elementos funcionales del aparato.....	70
Circuito hidráulico.....	72
Esquemas eléctricos.....	75
Altura de carga residual del circulator.....	79

**PT**

A **Ciao S** é conforme aos requisitos essenciais das seguintes Directivas:

- Directiva gás 2009/142/CEE;
- Directiva Rendimentos 92/42/CEE;
- Directiva Compatibilidade Electromagnética 2004/108/CEE;
- Directiva baixa tensão 2006/95/CEE

**PT**

Manual do instalador-Manual do utilizador.....	36-43
Dados técnicos.....	45
Painel de comando.....	69
Elementos funcionais do aparelho.....	70
Circuito hidráulico.....	72
Esquemas eléctricos.....	75
Prevalência residual do circulator.....	79

**SRB**

**Ciao S** je u skladu sa zahtevima sledećih Direktiva:

- Direktiva za gas 2009/142/CEE;
- Direktiva proizvodnje 92/42/CEE;
- Direktiva o elektromagnetnoj kompatibilnosti 2004/108/CEE;
- Direktiva o niskom naponu 2006/95/CEE

**SRB**

Priručnik za instalaciju-Priručnik za korisnike.....	47-54
Tehnički podaci.....	56
Kontrolna tabla.....	69
Funkcionalni elementi alata.....	70
Hidraulično kolo.....	72
Električne sheme.....	75
Prednost preostalog obrtanja.....	79

**TR**









**Ciao S** aşağıdaki Direktiflerin temel şartlarına uygunluk göstermektedir:

- Gazlı Cihaz Direktifi 2009/142/EEC;
- Verimlilik Direktifi 92/42/EEC;
- Elektromanyetik Uyumluluk direktifi 2004/108/EEC;
- Alçak Gerilim direktifi 2006/95/EEC

**TR**

Kurulum kılavuzu-Kullanım kılavuzu.....	58-65
Teknik veri.....	67
Kontrol paneli.....	69
Cihaz fonksiyonel elemanları.....	70
Hidrolik devre.....	72
Kablo diyagramları.....	75
Sirkülatör kalıntı başlığı.....	79



**EN INSTALLER****1 - GENERAL SAFETY DEVICES**

-  Our boilers are built in our plants and checked down to the smallest detail in order to protect users and fitters from injury. After working on the product, qualified personnel must check the electrical wiring, in particular the stripped part of conductors, which must not stick out from the terminal board, avoiding possible contact with live parts of such conductor.
-  This instruction manual, together with the user manual, are integral parts of the product: make sure that they remain with the appliance, even if it is transferred to another owner or user, or moved to another heating system. In case of loss or damage, please contact your local Technical Assistance Service for a new copy.
-  Boiler installation and any other assistance and maintenance operation must be carried out by qualified personnel according to current local and national regulations.
-  The installer must instruct the user about the operation of the appliance and about essential safety regulations.
-  This boiler must only be used for the application it was designed for. The manufacturer declines all contractual and non-contractual liability for injury to persons or animals or damage to property deriving from errors made during installation, adjustment and maintenance and from improper use.
-  After removing the packaging, make sure the content is in good conditions and complete. Otherwise, contact the dealer from who you purchased the appliance.
-  The safety valve outlet must be connected to a suitable collection and venting system. The manufacturer declines all liability for any damage caused due to any intervention carried out in the safety valve.
-  Dispose of all the packaging materials in the suitable containers at the corresponding collection centres.
-  Dispose of waste being careful not harm human health and without employing procedures or methods which may damage the environment.



During installation, inform the user that:

- in the event of water leaks, the water supply must be shut off and the Technical Assistance Service must be contacted immediately
- the operation pressure of the hydraulic system must be within 1 and 2 bar, and therefore, must not exceed 3 bar. If necessary, reset the pressure as indicated in the paragraph entitled "Filling the system"
- if the boiler has not been used for a long time, it is recommended that the Technical Assistance Service performs, at least, the following operations:
  - turn "off" the main switch of the appliance and the general switch of the system
  - close the gas and water taps on both the heating and domestic hot water circuits
  - drain the heating and domestic hot water circuits to prevent freezing
- boiler maintenance must be carried out at least once a year. This should be booked in advance with the Technical Assistance Service.







For safety, always remember that:

-  The boiler should not be used by children or unassisted disabled people.
-  It is dangerous to activate electrical devices or appliances, such as switches, home appliances, etc., if you smell gas or fumes. In the event of gas leaks, ventilate the room opening

In some parts of the manual, some symbols are used:

-  WARNING = for actions requiring special care and adequate preparation
-  FORBIDDEN = for actions THAT MUST NOT be performed

doors and windows; close the gas general tap; contact the qualified personnel from the Technical Assistance Service immediately

-  Do not touch the boiler while barefoot or if parts of your body are wet or damp
-  Before cleaning operations, disconnect the boiler from the main power supply by turning "OFF" the two position system switch and the main control panel switch
-  Do not modify safety and adjustment devices without the manufacturer's permission and relative instructions
-  Do not pull, disconnect or twist the electric cables coming out of the boiler even when it is disconnected from the main power supply
-  Avoid covering or reducing the size of ventilation openings of the installation room
-  Do not leave inflammable containers and substances in the installation room
-  Keep packaging materials out of reach of children.

**2 - BOILER DESCRIPTION**

**Ciao S C.S.I.** is a C-type wall-mounted boiler for heating and production of domestic hot water: according to the flue gas outlet device, the boiler is classified in categories B22P, B52P, C12, C22, C32, C42, C52, C62, C82, C92, C12x, C32x, C42x, C52x, C62x, C82x, C92x.

**Ciao S R.S.I.** is a Type C wall-mounted boiler that can function in various mode:

**MODE A**

Heating only without any external storage tank connected.

The boiler does not supply domestic hot water.

**MODE B**

Heating only with a thermostatically controlled external storage tank connected: in this condition, with every heat request from the storage tank thermostat, the boiler supplies hot water for the preparation of the domestic hot water.

**MODE C**

Heating only, with the connection of an external storage tank (accessory kit available upon request) (managed by a temperature probe) for preparing domestic hot water. When connecting the storage tank not supplied by us, make sure that the NTC probe has the following characteristics: 10 kOhm at 25°C, B 3435 ±1%

In configuration B22P and B52P (when installed indoors), the appliance cannot be installed in bedrooms, bathrooms, showers or where there are open fireplaces without a proper air flow. The room where the boiler is installed must have proper ventilation.

In configuration C, the appliance can be installed in any type of room and there are no limitations due to ventilation conditions or room volume.

**3 - INSTALLATION REGULATIONS****3.1 - Installation regulations**

Installation must be carried out by qualified personnel.

Always comply with national and local regulations.

**POSITION**

**Ciao S** can be installed indoors (fig. 2).

The boiler has protection that guarantees correct operation with a temperature range from 0°C to 60°C.

To take advantage of protections, the appliance must be able to start up, since any lockout condition (for example, absence of gas or electrical supply, or safety intervention) deactivates the protections.

**MINIMUM DISTANCES**

In order to have access to the boiler to perform regular maintenance operations, respect the minimum spaces foreseen for installation (fig. 3).

For correct appliance positioning:

- do not place it on a cooker or other cooking device
- do not leave inflammable products in the room where the boiler is installed
- heat sensitive walls (for example, wooden walls) must be protected with proper insulation.

**IMPORTANT**

Before installation, wash every system piping carefully in order to remove any residues that may impair the operation of the appliance. Under the safety valve, install a water collecting funnel with the corresponding discharge in the event of leaks due to the overpressure of the heating system. The domestic hot water circuit does not need a safety valve, but make sure that the pressure of waterworks does not exceed 6 bar. In case of doubts, install a pressure reducer. Prior to ignition, make sure that the boiler is designed to operate with the gas available; this can be checked by the message on the packaging and the adhesive label indicating the gas type. It is very important to highlight that in some cases the smoke pipes are under pressure and therefore, the connections of several elements must be airtight.

**ANTI-FREEZE SYSTEM**

The boiler is fitted as standard with an automatic anti-freeze system that activates when the temperature of the water in the primary circuit falls below 6 °C. This system is always active, guaranteeing boiler protection to an outdoor temperature level of -3 °C. To take advantage of this protection (based on burner operation), the boiler must be able to switch itself on; any lockout condition (e.g. lack of gas/electricity supply, or safety device intervention) therefore deactivates the protection.

The anti-freeze protection is also active when the boiler is on standby. In normal operation conditions, the boiler can protect itself against freezing. If the machine is left unpowered for long periods in areas where temperatures may fall below 0 °C, and you do not want to drain the heating system, you are advised to add a specific, good quality anti-freeze liquid to the primary circuit. Carefully follow the manufacturer's instructions with regards not only the percentage of anti-freeze liquid to be used for the minimum temperature at which you want to keep the machine circuit, but also the duration and disposal of the liquid itself.

For the domestic hot water part, we recommend you drain the circuit. The boiler component materials are resistant to ethylene glycol based anti-freeze liquids.

**3.2 Securing the boiler to the wall and hydraulic connections**

To fasten the boiler to the wall, use the cardboard template (fig. 4-5) in the packaging. The position and size of the hydraulic connections are indicated below:

- A** CH return 3/4"
- B** CH delivery 3/4"
- C** gas connection 3/4"
- D** DHW output 1/2" (for C.S.I.) - 3/4" (for R.S.I.)
- E** DHW input 1/2" (for C.S.I.) - 3/4" (for R.S.I.)

In case of replacement of Beretta boilers from previous type, there is an adaptation kit of hydraulic connections available.

**3.3 Electric connection**

The boilers leave the factory completely wired with the power cable already connected and they only need the connection of the ambient thermostat (AT) to be carried out in the specific terminals.

To access the terminal board:

- turn off the system general switch
- undo the fixing screws (A) of the shell (fig. 6)
- move forward and then upwards the shell base to unhook it from the chassis
- undo the fixing screws (B) of the instrument panel (fig. 7)
- turn the instrument panel upside down
- remove the terminal board cover (fig. 8)
- insert the cable of the possible T.A. (fig. 9)

The ambient thermostat must be connected as indicated on the wiring diagram.

 **Ambient thermostat input in safety low voltage (24 Vdc).**

The connection to the mains supply must be carried out through a separation device with an omnipolar opening of at least 3.5mm (EN 60335-1, category III).

The appliance operates with an alternating current of 230 Volt/50 Hz and an electrical power of 100W for 20 C.S.I. - 115W for 24 C.S.I. and 24 R.S.I. (and complies with the standard EN 60335-1).

 It is compulsory to carry out connection with an efficient earth circuit, according to national and local legislation.

 It is advisable to comply with neutral phase connection (L-N).

 The earth wire must be a couple of centimetres longer than the others.

 **Do not use gas and/or water pipes to earth electrical appliance.**

The manufacturer declines liability for any damage if the appliance was not connected to an earth circuit.

Use the **power cable supplied** to connect the boiler to the mains power supply.

**If the power cable is replaced, use a cable type HAR H05V2V2-F, 3 x 0.75 mm<sup>2</sup>, with max. outside diameter 7 mm.**

**3.4 Gas connection**

Before connecting the appliance to the gas network, check that:

- national and local regulations are complied
- the gas type is the one suitable for the appliance
- the piping is clean.

The gas pipe must be installed outdoor. If the pipe goes through the wall, it must go through the central opening, in the lower part of the template.

It is advisable to install a filter of suitable dimensions on the gas line if the distribution network had solid particles.

Once the appliance has been installed check that connections are sealed according to current installation regulations

**3.5 Fumes exhaustion and air suction**

For fumes exhaustion, refer to the current local and national regulations. Always comply with local standards of the Fire Department, the Gas Company and with possible municipal dispositions.

The release of combustion products is assured by a centrifugal fan placed inside the combustion chamber and its correct operation is constantly checked by a pressure switch. The boiler is supplied without the flue gas outlet/air suction kit, since it is possible to use the accessories for appliance with a forced draught sealed chamber that better adapts to the installation characteristics.

It is essential for flue gas release and the restoration of boiler combustion air to use certified pipes and that connection is carried out correctly as indicated by the instructions supplied with the flue gas accessories.

With only one smoke pipe you can connect more pieces of appliance provided that every piece of appliance is sealed chamber type.

**“FORCED OPEN” INSTALLATION (TYPE B22P/B52P)**

**Fumes outlet duct Ø 80 mm (fig. 10a)**

The fumes outlet duct can be aimed in the most suitable direction for installation needs. To install follow the instructions supplied with the kit.

 In this configuration, the boiler is connected to the Ø 80 mm fumes outlet duct by means of a Ø 60-80 mm adaptor.

In this case, the combustion supporting air is taken from the room in which the boiler is installed, which must be a suitable and ventilated technical room.

 Non-insulated fumes outlet ducts are potential sources of danger.

When necessary, the flue gas flange (F) must be removed using a screwdriver as a lever.

The boiler automatically adapts ventilation according to the type of installation and the length of the duct.

**20 C.S.I.**

Pipe length Ø 80 [m]	Flue gas flange (F)	Load losses for each bend (m)	
		45°	90°
up to 1,5	Ø 39	1,2	1,7
from 1,5 to 5	Ø 41 (**)		
from 5 to 14	Ø 43		

(\*\*) fitted in boiler

24 C.S.I. - 24 R.S.I.

Pipe length ø 80 [m]	Flue gas flange (F)	Load losses for each bend (m)	
		45°	90°
2	Ø 42	1,2	1,7
from 2 to 8	Ø 44 (**)		
from 8 to 25	not installed		

(\*\*) fitted in boiler

CONCENTRIC OUTLETS (ø 60-100)

The boiler has been designed to be connected to concentric outlet/suction pipes and with the opening for air suction (E) closed (fig. 10b). The concentric outlets can be placed in the most suitable direction according to room requirements, complying with the maximum lengths indicated in the table. For installation, follow the instructions supplied with the kit. According to the length of the pipes used, it is necessary to insert a flange, selecting one from those contained in the boiler (see the following table). When necessary, the flue gas flange (F) must be removed using a screwdriver as a lever. The table indicates the permitted linear lengths. According to the length of the pipes used, it is necessary to insert a flange, selecting one from those contained in the boiler (see the following table).

20 C.S.I.

Pipe length ø 60-100 [m]	Flue gas flange (F)	Load losses for each bend (m)	
		45°	90°
up to 0,85	Ø 39	1	1,5
from 0,85 to 2,35	Ø 41 (**)		
from 2,35 to 4,25	Ø 43		

(\*\*) fitted in boiler

24 C.S.I. - 24 R.S.I.

Pipe length ø 60-100 [m]	Flue gas flange (F)	Load losses for each bend (m)	
		45°	90°
up to 0,85	Ø 42	1	1,5
from 0,85 to 2,35	Ø 44 (**)		
from 2,35 to 4,25	not installed		

(\*\*) fitted in boiler

Concentric pipes (ø 80/125)

The boiler has been designed to be connected to concentric outlet/suction pipes and with the opening for air suction closed. The concentric outlets can be placed in the most suitable direction according to room requirements, complying with the maximum lengths indicated in the table. For installation, follow the instructions supplied with the kit. To go through the wall, drill a hole of Ø 140 mm. According to the length of the pipes used, it is necessary to insert a flange selecting from those contained in the boiler (see table). Pay special attention to external temperature and pipe length. Refer to the diagrams in order to establish if it is compulsory or not to use a condensation collector. In case of operation at temperature lower than 60 °C, it is compulsory to use a condensation collector. If a condensation collector is used, provide a slope of the flue exhaust pipe of 1% towards the collector. Connect the condensation trap syphon to a white water outlet pipe. Non insulated outlet pipes are potential sources of danger.

20 C.S.I.

Pipe length Ø 80 125 [m]	Flue gas flange (F)	Load losses for each bend (m)	
		45°	90°
from 0,96 to 3,85	Ø 39	1,35	2,2
from 3,85 to 7,85	Ø 41 (**)		
from 7,85 to 12,40	Ø 43		

(\*\*) fitted in boiler

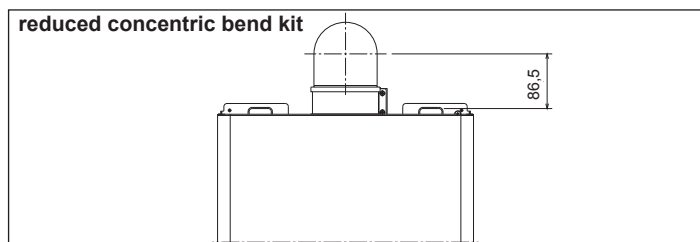
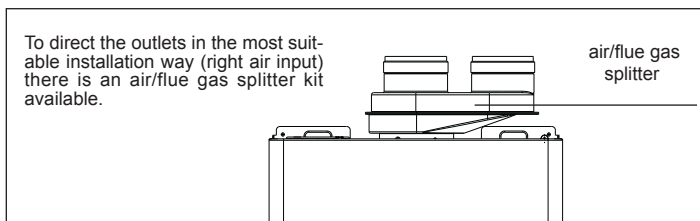
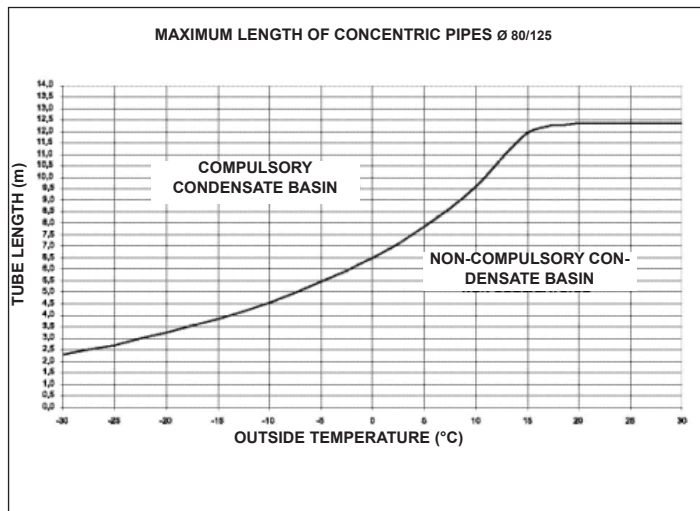

⚠ If it is necessary to install Ciao S on existing systems (replacement of Ciao N/Ciao range), there is a "reduced concentric bend" kit that allows boiler positioning while keeping the same flue gas hole.

Pipe length with reduced bend [m]	Flue gas flange (F)		Load losses for each bend (m)	
	Ciao S 20 C.S.I.	Ciao S 24 C.S.I.	45°	90°
up to 1.85	Ø 41	Ø 44	1	1.5
from 1.85 to 4.25	Ø 43	no flange		

24 C.S.I. - 24 R.S.I.

Pipe length Ø 80 125 [m]	Flue gas flange (F)	Load losses for each bend (m)	
		45°	90°
from 0,96 to 3,85	Ø 42	1,35	2,2
from 3,85 to 7,85	Ø 44 (**)		
from 7,85 to 12,4	not installed		

(\*\*) fitted in boiler

**TWIN OUTLETS (ø 80) (fig. 11)**

Twin outlets can be placed in the most suitable direction according to the room requirements.

To use the combustion air suction pipe, one of the two inlets (G and H) must be selected. Remove the closure plug which is fixed using screws, and use the specific adaptor relating to the inlet selected.

⚠ The air inlet adaptor ø 80 (X) must be correctly oriented, it is therefore necessary to fix it using the appropriate screws, so that the locating tab does not interfere with the casing: X air inlet adaptor ø 80 - Y air inlet adaptor from ø 60 to ø 80.

When necessary, the flue gas flange (F) must be removed using a screwdriver as a lever. The table indicates the permitted linear lengths. According to the length of the pipes used, it is necessary to insert a flange, selecting one from those contained in the boiler (see the following table).

**20 C.S.I.**

Pipe length ø 80 [m]	Flue gas flange (F)	Load losses for each bend (m)	
		45°	90°
1+1	Ø 39	1,2	1,7
> 1+1 ÷ 4+4	Ø 41 (**)		
> 4+4 ÷ 10+10	Ø 43		

(\*\*) fitted in boiler

**24 C.S.I. - 24 R.S.I.**

Pipe length ø 80 [m]	Flue gas flange (F)	Load losses for each bend (m)	
		45°	90°
2+2	Ø 42	1,2	1,7
>2+2 ÷ 6+6	Ø 44 (**)		
>6+6 ÷ 16+16	not installed		

(\*\*) fitted in boiler

**3.6 Filling the heating system (fig. 13)**

Once the hydraulic connections have been carried out, fill the heating system. This operation must be carried out with cold system following this instructions:

- turn by two or three turns the automatic relief valve cap (I)
- make sure the cold water inlet tap is open
- turn on the filling tap (L fig. 13 for C.S.I. - external for R.S.I.) until the pressure indicated by the water pressure gauge is between 1 and 1.5 bar.

Once filling is complete, close the filling tap.

The boiler has an efficient air separator so no manual intervention is needed. The burner switches on only if the air relief phase is finished.

**3.7 Emptying the heating system**

To empty the system, proceed as follow:

- switch off the boiler
- loose the boiler outlet tap (M)
- empty the lowest points of the system.

**3.8 Emptying the domestic hot water (only for C.S.I. model)**

When there is risk of frost, the domestic hot water system must be emptied in the following way:

- close the main tap of the water mains
- open all the hot and cold water taps
- empty the lowest points.

**WARNING**

When carrying out the discharge of the safety valve (N), it must be connected to a suitable collection system. The manufacturer is not responsible for possible damages due to safety valve operation.

**B22P/B52P** Suction indoors and discharge outdoors  
**C12-C12x** Discharge via concentric wall outlet. The pipes may leave the boiler independently, but the outlets must be concentric or sufficiently close together to be subjected to similar wind conditions (within 50 cm)  
**C22** Discharge via concentric outlet in common smoke pipe (suction and discharge in the same pipe)  
**C32-C32x** Discharge via concentric roof outlet. Outlets as for C13  
**C42-C42x** Discharge and suction in common separate smoke pipes, but subjected to similar wind conditions  
**C52-C52x** Separate discharge and suction lines on wall or roof and in areas with different pressures. The discharge and suction lines must never be positioned on opposite walls  
**C62-C62x** Discharge and suction lines using pipes marketed and certified separately (1856/1)  
**C82-C82x** Discharge via single or common smoke pipe and wall suction line  
**C92-C92x** Discharge on roof (similar to C33) and air suction from a single existing smoke pipe

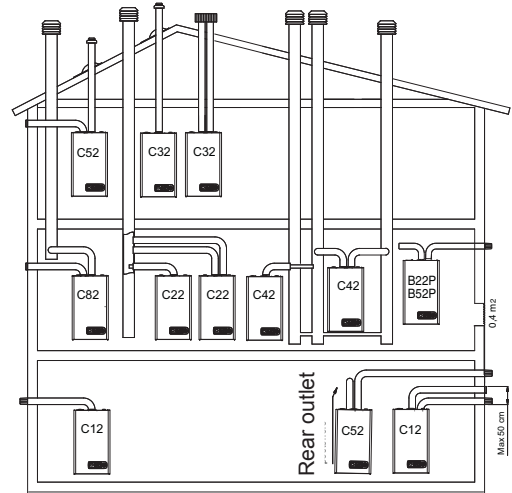

## 4 IGNITION AND OPERATION

### 4.1 Preliminary checks

First ignition is carried out by competent personnel from an authorised Technical Assistance Service Beretta.

Before starting up the boiler, check:

- that the supply networks data (electric, water, gas) corresponds to the label data
- that piping leaving the boiler is covered by thermal insulation sheath
- that flue gas extraction and air suction pipes work correctly
- that conditions for regular maintenance are guaranteed if the boiler is placed inside or between furniture
- the seal of the fuel adduction system
- that fuel capacity corresponds to values requested by the boiler
- that the fuel supply system has the correct capacity for the necessary capacity to the boiler and that it has all the safety and control devices prescribed by current regulations.

### 4.2 Appliance ignition



To start-up the boiler it is necessary to carry out the following operations:

- power the boiler
- open the gas tap present in the system to allow fuel flow
- turn the mode selector (1 - fig. 1a) to the desired position:

#### Ciao S C.S.I.:

**Summer mode:** turning the selector to the symbol summer  (fig. 2a) the traditional function of only domestic hot water is activated. If there is a domestic hot water request the digital display shows the hot water system temperature, the icon to indicate the hot water supply and the flame icon

**Winter mode:** by turning the mode selector within the area marked + and - (fig. 2b), the boiler provides domestic hot water and heating. If there is a heat request, the boiler switches on and the digital monitor indicates the heating water temperature, the icon to indicate heating and the flame icon (fig. 3a). If there is a domestic hot water request, the boiler switches on and the digital display shows the hot water system temperature, the icon to indicate the hot water supply and the flame icon (fig. 4a)

**Pre-heating (faster hot water):** rotate the domestic hot water temperature adjustment knob (2 - fig. 1a) to the  symbol (fig. 5a), to activate the pre-heating function. This function keeps the water in the domestic hot water exchanger hot, to reduce standby times when a request is made. When the pre-heating function is enabled, the monitor indicates the delivery temperature of the heating water or the domestic hot water, according to the current request. During burner ignition following a pre-heating request, the monitor indicates the **P** symbol (fig. 5b). To deactivate the pre-heating function, rotate the domestic hot water temperature adjustment knob back to the  symbol. Bring the domestic hot water temperature adjustment knob back to the required position. This function cannot be activated when the boiler is OFF: function selector (1 fig.1a) on  OFF.

#### Ciao S R.S.I.:

**Summer mode (only with the external water tank connected):** turning the selector to the symbol summer  (fig. 2a) the traditional function of only domestic hot water is activated and the boiler supplies water at the temperature set on the external storage tank. If there is a domestic hot water request the digital display shows the hot water system temperature, the icon to indicate the hot water supply and the flame icon

**Winter mode:** by turning the mode selector within the area marked + and - (fig. 2b), the boiler provides hot water for heating and - if connected to an external storage tank - domestic hot water. If there is a heat request, the boiler switches on and the digital monitor indicates the heating water temperature, the icon to indicate heating and the flame icon (fig. 3a). If there is a domestic hot water request, the boiler switches on and the digital display shows the hot water system temperature, the icon to indicate the hot water supply and the flame icon (fig. 4a).

Adjust the ambient thermostat to the required temperature (~20°C)

#### Ciao S C.S.I.: Adjustment of domestic hot water temperature

To adjust domestic water temperature (bathrooms, showers, kitchen, etc.), turn the knob with symbol  (fig. 2b) within the area marked + and -.

The boiler is standby status until, after a heat request, the burner switches on and the digital display shows the hot water system temperature, the icon to indicate the hot water supply and the flame icon. The boiler will be in function until the adjusted temperature is reached, afterwards it will be in "standby" again.

If the red indicator light near the  symbol on the command panel lights up, this means the boiler is in temporary stop status (see the chapter about light signals and faults). The digital monitor indicates the fault code detected (fig. 6a).

#### Ciao S R.S.I.: Adjustment of the domestic hot water temperature

**CASE A** heating only - adjustment does not apply

**CASE B** heating only + external storage tank with thermostat - adjustment does not apply.

**CASE C** heating only + external storage tank with probe - to adjust the temperature of the domestic hot water in the storage tank, turn the knob-but with the symbol clockwise to increase water temperature and anti-clockwise to lower it.

The boiler is standby status until, after a heat request, the burner switches on and the digital display shows the hot water system temperature, the icon to indicate the hot water supply and the flame icon. The boiler will be in function until the adjusted temperature is reached, afterwards it will be in "standby" again.

If the red indicator light near the  symbol on the command panel lights up, this means the boiler is in temporary stop status (see the chapter about light signals and faults). The digital monitor indicates the fault code detected (fig. 6a)

#### Ciao S C.S.I. - Ciao S R.S.I.: Environment Automatic Adjustment System Function (S.A.R.A.) fig. 7a

By setting the heating water temperature selector to the area marked by AUTO - temperature value from 55 to 65°C - the S.A.R.A. self-adjusting system is activated: the boiler varies the delivery temperature according to the closing signal of the ambient thermostat. When the temperature set with the heating water temperature selector is reached, a 20 minutes count begins. If during this period the ambient thermostat still requests heat, the value of the set temperature automatically increases by 5 °C.

When the new value is reached, other 20 minutes count begins.

If during this period the ambient thermostat still requests heat, the value of the set temperature automatically increases by 5 °C.

This new temperature value is the result of the temperature set manually with the heating water temperature selector and the increase of +10 °C of the S.A.R.A. function.



After the second cycle the temperature value should be kept at the set value +10°C until the request of the ambient thermostat is satisfied.

### 4.3 Switching off

#### Temporary switching off

In case of absence for short periods of time, set the mode selector (1 - fig. 1a) to  (OFF).

In this way (leaving the electricity and fuel supplies enabled), the boiler is protected by the following systems:

- **Anti-frost device:** when the temperature of the water in the boiler falls below 5°C, the circulator and, if necessary, the burner are activated at minimum output levels to bring the water temperature back to the values for safety (35°C). During the anti-frost cycle, the symbol  appears on the digital monitor.
- **Circulator anti-blocking function:** an operation cycle is activated every 24 hours.
- **DHW Antifreeze (only when connected to an external storage tank with probe):** the function is activated if the temperature measured by the storage tank probe drops below 5° C. A heat request is generated in this phase with the ignition of the burner at minimum power, which is maintained until the water temperature reaches 55° C. During the anti-frost cycle, the symbol  appears on the digital monitor.





















### Long period switching off

In case of absence for long periods of time, set the mode selector (1 - fig. 1a) to  (OFF).

Then, close the gas tap present on the system. In this case, anti-frost device is deactivated: empty the systems, in case of risk of frost.



### 4.4 Light signals and faults

The operating status of the boiler is shown on the digital display, below is a list of the types of displays.

BOILER STATUS	DISPLAY
Stand-by	-
OFF status	OFF
ACF module lockout alarm	A01  
ACF electrical fault alarm	A01  
Limit thermostat alarm	A02 
Air pressure switch alarm	A03 
H2O pressure switch alarm	A04  
NTC domestic water fault (C.S.I. and R.S.I only with external storage heater with probe)	A06 
NTC heating fault	A07 
Parasite flame	A11 
Electric calibration min and max heating	ADJ 
Transient awaiting ignition	88°C flashing
Air pressure switch intervention	 flashing
H2O pressure switch intervention	  flashing
Preheating Function active (only C.S.I.)	P
Preheating heat request (only C.S.I.)	P flashing
External probe present	
Domestic water heat request	60°C 
Heating heat request	80°C 
Anti-freeze heat request	
Flame present	

### To restore operation (deactivate alarms):

#### Faults A 01-02-03



Position the function selector to  (OFF), wait 5-6 seconds then set it to the required position  (summer mode) or  (winter mode).

If the reset attempts do not reactivate the boiler, contact the Technical Assistance Centre.

#### Fault A 04

In addition to the fault code, the digital display shows the symbol . Check the pressure value indicated by the water gauge:

if it is less than 0.3 bar, position the function selector to  (OFF) and adjust the filling tap (L fig. 13 for C.S.I. - external for R.S.I.) until the pressure reaches a value between 1 and 1.5 bar.

Then position the mode selector to the desired position  (summer) or  (winter).

The boiler will perform one purge cycle lasting approximately 2 minutes.

If pressure drops are frequent, request the intervention of the Technical Assistance Service.

#### Fault A 06 (only C.S.I.)

The boiler operates normally but cannot reliably maintain a constant domestic hot water temperature, which remains set at around 50°C. Contact the Technical Assistance Centre.

#### Fault A 07

Contact the Technical Assistance Centre.

### 4.5 Adjustments

The boiler has already been adjusted by the manufacturer.

If it is necessary to adjust it again, for example after extraordinary maintenance, after replacement of gas valve or after gas conversion, carry out the following procedure.

 **The maximum output adjustment must be carried out in the sequence indicated exclusively by qualified personnel.**

- remove the shell unscrewing the fixing screws A (fig. 6)
- unscrew by two turns the screw of the pressure test point downstream the gas valve and connecting the pressure gauge
- disconnect the compensation inlet of the air distribution box

#### 4.5.1 Ciao S C.S.I.: Maximum power and minimum domestic hot water adjustment

- Fully open the hot water tap
- on the control panel:
- set the mode selector to  (summer) (fig. 2a)
- turn the domestic hot water temperature selector to its maximum (fig. 8a)
- power the boiler setting the system main switch to "on"
- check that the pressure on the pressure gauge is stable; or with a milliammeter in series to the modulator, make sure that the modulator supplies the maximum available current (120 mA for G20 and 165 mA for LPG).
- carefully prise out the protection cap of the adjustment screws, using a screwdriver (fig. 15)
- with a fork spanner CH10 use the adjustment nut of the maximum output in order to obtain the value indicated in table "Technical data"
- disconnect the modulator faston
- wait until the pressure on the pressure gauge is stable at minimum value
- paying attention not to press the internal shaft, use an Allen spanner to turn the red adjustment screw for domestic hot water minimum temperature regulation, calibrating it until the pressure gauge reads the value indicated in the table "Technical data"
- reconnect the modulator faston
- close the domestic hot water tap
- carefully refit the protection cap of the adjustment screws.

#### Ciao S R.S.I.: Maximum and minimum power adjustment

- Set the function selector to  (winter) (fig. 2b)
- Remove the housing and access the card
- Insert the jumpers JP1 and JP2
- Bring the trimmer P2 to the maximum value, using a screwdriver (turn clockwise)
- Power the boiler setting the system main switch to "on"
- Check the pressure on the pressure gauge is stable; or, with a milliammeter in series to the modulator, make sure the modulator supplies the maximum available current (120 mA for G20 and 165 mA for LPG)
- Use a screwdriver to carefully prise out the protection cap of the adjustment screws
- With a fork spanner CH10, use the adjustment nut of the maximum output in order to obtain the value indicated in the table "Technical data"
- Disconnect the modulator faston
- Wait until the pressure on the pressure gauge is stable at minimum value
- Use an Allen spanner to set the red adjustment screw at the minimum output, calibrating it until the pressure gauge shows the value indicated in the table "Technical data"
- Reconnect the modulator faston
- Disconnect the boiler from the power supply
- Remove the jumpers JP1 and JP2
- Carefully refit the protection cap of the adjustment screws.

#### 4.5.2 Minimum and maximum heating electric adjustment

 The "electric adjustment" function is activated and deactivated exclusively by the jumper (JP1) (fig. 16).

ADJ  appears on the display to indicate that the calibration procedure is underway.

The function can be enabled in the following way:

- by powering the card with the jumper JP1 inserted and the mode selector in winter position, independently from the possible presence of other operation request.
- by inserting the jumper JP1, with the mode selector in winter position, without heat request in progress.



⚠ By activating the function the burner is ignited through simulation of heat request in heating.

To perform calibration operations, proceed as follow:

- switch off the boiler
- remove the shell and access the card
- insert the jumper JP1 (fig. 16) to enable the knobs placed on the control panel to the minimum and maximum heating adjustment functions.
- make sure that the mode selector is in winter position (see section 4.2).
- power the boiler

#### ⚠ Electric card in voltage (230 Volt)

- turn the heating water temperature adjustment knob **B** (fig. 17) until it reaches the minimum heating value as indicated in the multigas table
- insert the jumper JP2 (fig. 16)
- turn the domestic hot water temperature adjustment knob **C** (fig. 17) until it reaches the maximum heating value as indicated in the multigas table
- remove the jumper JP2 to store the maximum heating value
- **remove the jumper JP1 to store the heating minimum value and to get out the calibration procedure**
- reconnect the compensation inlet to the air distribution box

Disconnect the pressure gauge and retighten the pressure test point screw.

⚠ To finish the calibration function without storing the set values, proceed as follows:

- a) set the mode selector to position  (OFF)
- b) remove power supply voltage
- c) remove JP1/JP2

⚠ The calibration function is automatically finished, without storing minimum and maximum values, after 15 minutes of its activation.

⚠ The function is automatically finished also in case of definitive stop or lockout.  
Also in this case, function conclusion DOES NOT provide values storing.

#### Note

To calibrate only maximum heating, it is possible to remove the jumper JP2 (to store the maximum) and then get out from the function, without storing the minimum, setting the mode selector to  (OFF) or removing the voltage from the boiler.

⚠ After each intervention on the adjustment element of the gas valve, seal it with sealing varnish.

When adjustment is complete:

- restore set temperature with the ambient thermostat to the desired temperature
- set the heating water temperature selector to the desired position
- close the instrument panel
- pull the shell back in place.

### 4.6 Gas conversion operations

Conversion from a family gas to other family gas can be performed easily also when the boiler is installed.

The boiler is designed to operate with methane gas (G20) according to the product label.

It is possible to convert the boilers from one gas type to another by using the appropriate kit supplied upon request:

- Methane conversion kit
- LPG conversion kit

For disassembly refer to instructions below:

- remove power supply from the boiler and close the gas tap
- remove in sequence: shell, air distribution box cover and combustion chamber cover (fig. 19)
- disconnect the spark plug cable connection
- slide off the lower cable grommet from the seat of the air distribution box
- remove the burner fixing screws and remove the latter with the spark plug attached and corresponding cables
- using a socket or fork spanner, remove the nozzles and the washers and replace them with the ones in the kit.

⚠ Use and assemble the washers contained in the kit also in case of manifolds without washers.

- reinsert the burner in the combustion chamber and tighten the screws fixing it to the gas manifold
- place the cable grommet with the spark plug cable in its seat in the air distribution box
- restore connection of the spark plug cable
- refit the combustion chamber cover and the cover of the air distribution box
- overturn the control instrument panel towards the boiler front part
- open the card cover
- on the control card (fig. 16):
  - if the conversion is from methane gas to LPG, insert the jumper in position JP3
  - if the conversion is from LPG to methane gas, remove the jumper from position JP3
- reposition the components previously removed
- restore voltage to the boiler and reopen the gas tap (with boiler in operation, check correct seal of the gas feeding circuit connections).

⚠ Conversion must be carried out by qualified personnel.

⚠ After conversion, adjust the boiler again following the indications in specific section and apply the new identification label contained in the kit.

## 5 MAINTENANCE

To ensure product characteristics and efficiency remain intact and to comply with prescriptions of current regulations, it is necessary to render the appliance to systematic checks at regular intervals. Control frequency depends on the installation and use conditions, but it is therefore necessary an annual check-up by the authorised personnel from the Technical Assistance Service.

Turn off the appliance to carry out the maintenance of the structure near the flue exhaust connections or devices, and their accessories. Once the interventions are finished a qualified technician must check that the pipes and the devices work correctly.

**IMPORTANT:** before carrying out any cleaning or maintenance operation of the appliance, use the appliance and system switch to interrupt power supply and close the gas supply turning the tap placed on the boiler.

Do not clean the appliance or its parts with inflammable substances (e.g. petrol, alcohol, etc.).

Do not clean panels, painted parts and plastic parts with paint thinner. Panel cleaning must be carried out only with soapy water.

### 5.1 Check the combustion parameters

#### Ciao S C.S.I.:

To carry out the combustion analysis, proceed as follows:

- open the hot water tap to its maximum output
- set the mode selector to summer  and the domestic hot water temperature selector to the maximum value (fig. 8a).
- remove the screw of the combustion analysis inlet cover (fig. 18) and insert the probes
- power the boiler

#### Ciao S R.S.I.:

- switch off the boiler
- set the function selector to winter mode
- remove the housing and access the card
- insert the jumpers JP1 and JP2
- use a screwdriver to prise open the plug on the control panel
- bring the trimmer P2 to the maximum value, using a screwdriver (turn clockwise)
- remove the screw of the combustion analysis inlet cover (fig. 18) and insert the probes
- power the boiler

The appliance works at maximum output and it is possible to check combustion.

After analysis is complete:

- close the hot water tap
- remove the probe from the analyser and close the combustion analysis inlet fastening carefully the screw previously removed.

## USER

### 1A GENERAL WARNINGS

The instruction manual is an integral part of the product and it must therefore be kept carefully and must accompany the appliance; if the manual is lost or damaged, another copy must be requested from the Technical Assistance Service.

- ⚠ Boiler installation and any other assistance and maintenance operation must be carried out by qualified personnel according to current local and national regulations.
- ⚠ For installation, it is advisable to contact specialised personnel.
- ⚠ The boiler must only be used for the application foreseen by the manufacturer. The manufacturer shall not be liable for any damage to persons, animals or property due to errors in installation, calibration, maintenance or due to improper use.
- ⚠ The safety and automatic adjustment devices must not be modified, during the system life cycle, by the manufacturer or supplier.
- ⚠ This appliance produces hot water, therefore it must be connected to a heating system and/or a domestic hot water mains, compatible with its performance and output.
- ⚠ In case of water leakage, close the water supply and contact the Technical Assistance Service immediately.
- ⚠ In case of absence for long periods time, close the gas supply and switch off the electrical supply main switch. In case of risk of frost, empty the boiler.
- ⚠ From time to time check that the operating pressure of the hydraulic system does not decrease under 1 bar.
- ⚠ In case of failure and/or malfunctioning, deactivate the appliance, and do not try to repair or intervene directly on it.
- ⚠ Appliance maintenance must be carried out at least once a year: program it with the Technical Assistance Service will avoid wasting time and money.

Boiler use requires to strictly observe some basic safety rules:

- ⊘ Do not use the appliance in any manner other than its intended purpose.
- ⊘ It is dangerous to touch the appliance with wet or damp body parts and/or in bare feet.
- ⊘ Under no circumstances cover the intake grids, dissipation grids and ventilation vents in the installation room with cloths, paper or any other material.
- ⊘ Do not activate electrical switches, telephone or any other object that causes sparks if there is a smell of gas. Ventilate the room by opening doors and windows and close the gas central tap.
- ⊘ Do not place anything in the boiler.
- ⊘ Do not perform any cleaning operation if the appliance is not disconnected from the main power supply.
- ⊘ Do not cover or reduce ventilation opening of the room where the generator is installed.
- ⊘ Do not leave containers and inflammable products in the installation room.
- ⊘ Do not attempt to repair the appliance in case of failure and/or malfunctioning.
- ⊘ It is dangerous to pull or twist the electric cables.
- ⊘ Children or unskilled persons must not use the appliance.
- ⊘ Do not intervene on sealed elements.

For better use, remember that:

- a periodic external cleaning with soapy water not only improves its aesthetic aspect but also preserves panelling from corrosion, extending its life cycle;
- if the wall-mounted boiler is enclosed in pendant furniture, leave at least 5 cm for ventilation and maintenance;
- installation of an ambient thermostat will favour a greater comfort, a more rational use of the heat and energy saving; the boiler can also be connected to a programming clock in order to manage ignition and switching off during the day or week.

### 2A IGNITION

First ignition must be carried out by personnel from the Technical Assistance Service. At the same time, if it is necessary to put the appliance in service again, carefully follow the described operations.

To start-up the boiler it is necessary to carry out the following operations:

- power the boiler
- open the gas tap present in the system to allow fuel flow
- turn the mode selector (1 - fig. 1a) to the desired position:

#### Ciao S C.S.I.:

**Summer mode:** turning the selector to the symbol summer ☀ (fig. 2a) the traditional function of only domestic hot water is activated. If there is a domestic hot water request the digital display shows the hot water system temperature, the icon to indicate the hot water supply and the flame icon

**Winter mode:** by turning the mode selector within the area marked + and - (fig. 2b), the boiler provides domestic hot water and heating. If there is a heat request, the boiler switches on and the digital monitor indicates the heating water temperature, the icon to indicate heating and the flame icon (fig. 3a). If there is a domestic hot water request, the boiler switches on and the digital display shows the hot water system temperature, the icon to indicate the hot water supply and the flame icon (fig. 4a)

**Pre-heating (faster hot water):** rotate the domestic hot water temperature adjustment knob (2 - fig. 1a) to the ☺ symbol (fig. 5a), to activate the pre-heating function. This function keeps the water in the domestic hot water exchanger hot, to reduce standby times when a request is made. When the pre-heating function is enabled, the monitor indicates the delivery temperature of the heating water or the domestic hot water, according to the current request. During burner ignition following a pre-heating request, the monitor indicates the P symbol (fig. 5b). To deactivate the pre-heating function, rotate the domestic hot water temperature adjustment knob back to the ☺ symbol. Bring the domestic hot water temperature adjustment knob back to the required position. This function cannot be activated when the boiler is OFF: function selector (1 fig.1a) on ⏻ OFF.

#### Ciao S R.S.I.:

**Summer mode (only with the external water tank connected):** turning the selector to the symbol summer ☀ (fig. 2a) the traditional function of only domestic hot water is activated and the boiler supplies water at the temperature set on the external storage tank. If there is a domestic hot water request the digital display shows the hot water system temperature, the icon to indicate the hot water supply and the flame icon

**Winter mode:** by turning the mode selector within the area marked + and - (fig. 2b), the boiler provides hot water for heating and - if connected to an external storage tank - domestic hot water. If there is a heat request, the boiler switches on and the digital monitor indicates the heating water temperature, the icon to indicate heating and the flame icon (fig. 3a). If there is a domestic hot water request, the boiler switches on and the digital display shows the hot water system temperature, the icon to indicate the hot water supply and the flame icon (fig. 4a).

Adjust the ambient thermostat to the required temperature (~20°C)

#### Ciao S C.S.I.: Adjustment of domestic hot water temperature

To adjust domestic water temperature (bathrooms, showers, kitchen, etc.), turn the knob with symbol ☀ (fig. 2b) within the area marked + and -. The boiler is standby status until, after a heat request, the burner switches on and the digital display shows the hot water system temperature, the icon to indicate the hot water supply and the flame icon. The boiler will be in function until the adjusted temperature is reached, afterwards it will be in "standby" again.

If the red indicator light near the ⚠ symbol on the command panel lights up, this means the boiler is in temporary stop status (see the chapter about light signals and faults). The digital monitor indicates the fault code detected (fig. 6a).

#### Ciao S R.S.I.: Adjustment of the domestic hot water temperature

**CASE A** heating only - adjustment does not apply

**CASE B** heating only + external storage tank with thermostat - adjustment does not apply.

**CASE C** heating only + external storage tank with probe - to adjust

the temperature of the domestic hot water in the storage tank, turn the knob-but with the symbol clockwise to increase water temperature and anti-clockwise to lower it.

The boiler is standby status until, after a heat request, the burner switches on and the digital display shows the hot water system temperature, the icon to indicate the hot water supply and the flame icon. The boiler will be in function until the adjusted temperature is reached, afterwards it will be in "standby" again.

If the red indicator light near the  symbol on the command panel lights up, this means the boiler is in temporary stop status (see the chapter about light signals and faults). The digital monitor indicates the fault code detected (fig. 6a)

### Ciao S C.S.I. - Ciao S R.S.I.: Environment Automatic Adjustment System Function (S.A.R.A.) fig. 7a

By setting the heating water temperature selector to the area marked by AUTO - temperature value from 55 to 65°C - the S.A.R.A. self-adjusting system is activated: the boiler varies the delivery temperature according to the closing signal of the ambient thermostat. When the temperature set with the heating water temperature selector is reached, a 20 minutes count begins. If during this period the ambient thermostat still requests heat, the value of the set temperature automatically increases by 5 °C.

When the new value is reached, other 20 minutes count begins.

If during this period the ambient thermostat still requests heat, the value of the set temperature automatically increases by 5 °C.

This new temperature value is the result of the temperature set manually with the heating water temperature selector and the increase of +10 °C of the S.A.R.A function.



After the second cycle the temperature value should be kept at the set value +10°C until the request of the ambient thermostat is met.

### 3A SWITCHING OFF

#### Temporary switching off

In case of absence for short periods of time, set the mode selector (1 - fig. 1a) to  (OFF).

In this way (leaving the electricity and fuel supplies enabled), the boiler is protected by the following systems:

- **Anti-frost device:** when the temperature of the water in the boiler falls below 5°C, the circulator and, if necessary, the burner are activated at minimum output levels to bring the water temperature back to the values for safety (35°C). During the anti-frost cycle, the symbol  appears on the digital monitor.
- **Circulator anti-blocking function:** an operation cycle is activated every 24 hours.
- **DHW Antifreeze (only when connected to an external storage tank with probe):** the function is activated if the temperature measured by the storage tank probe drops below 5° C. A heat request is generated in this phase with the ignition of the burner at minimum power, which is maintained until the water temperature reaches 55° C. During the anti-frost cycle, the symbol  appears on the digital monitor.

#### Long period switching off

In case of absence for long periods of time, set the mode selector (1 - fig. 1a) to  (OFF).

Then, close the gas tap present on the system. In this case, anti-frost device is deactivated: empty the systems, in case of risk of frost.

### 4A CONTROLS





















At the beginning of the heating season, and occasionally during use, make sure the hydrometer-thermohydrometer indicates cold system pressure values between 0.6 and 1.5 bar: this avoids system noise levels due to the presence of air. In case of insufficient water circulation, the boiler will switch off. Under no circumstances, water pressure must be below 0.5 bar (red field).

If this condition is checked, it is necessary to restore water pressure in the boiler proceeding as follows:

- set the mode selector (2 - fig.1a) to  (OFF)
- turn on the filling tap (L fig. 13 for C.S.I. - external for R.S.I.) until the pressure value is between 1 and 1.5 bar. Carefully close the tap.
- Replace the mode selector on the initial position.
- If pressure drop is frequent, contact the Technical Assistance Service.



### 5A LIGHT SIGNALS AND FAULTS

The operating status of the boiler is shown on the digital display, below is a list of the types of displays.

BOILER STATUS	DISPLAY
Stand-by	-
OFF status	OFF
ACF module lockout alarm	A01  
ACF electrical fault alarm	A01  
Limit thermostat alarm	A02 
Air pressure switch alarm	A03 
H2O pressure switch alarm	A04  
NTC domestic hot water fault (C.S.I. and R.S.I. only with external storage heater with probe)	A06 
NTC heating fault	A07 
Parasite flame	A11 
Electric calibration min and max heating	ADJ 
Transitory awaiting ignition	88°C flashing
Air pressure switch intervention	 flashing
H2O pressure switch intervention	  flashing
Preheating Function active (only C.S.I.)	P
Preheating heat request (only C.S.I.)	P flashing
External probe present	
Domestic water heat request	60°C 
Heating heat request	80°C 
Anti-freeze heat request	
Flame present	





#### To restore operation (deactivate alarms):

##### Faults A 01-02-03

Position the function selector to  (OFF), wait 5-6 seconds then set it to the required position  (summer mode) or  (winter mode).

If the reset attempts do not reactivate the boiler, contact the Technical Assistance Centre.

##### Fault A 04

In addition to the fault code, the digital display shows the symbol . Check the pressure value indicated by the water gauge: if it is less than 0.3 bar, position the function selector to  (OFF) and adjust the filling tap (L fig. 13 for C.S.I. - external for R.S.I.) until the pressure reaches a value between 1 and 1.5 bar. Then position the mode selector to the desired position  (summer) or  (winter).

The boiler will perform one purge cycle lasting approximately 2 minutes.

If pressure drops are frequent, request the intervention of the Technical Assistance Service.

##### Fault A 06 (only C.S.I.)

The boiler operates normally but cannot reliably maintain a constant domestic hot water temperature, which remains set at around 50°C. Contact the Technical Assistance Centre.

##### Fault A 07

Contact the Technical Assistance Centre.

## TECHNICAL DATA

DESCRIPTION			CIAO 20 S C.S.I.	CIAO 24 S C.S.I.	CIAO 24 S R.S.I.
<b>Heating</b>	Heat input	kW	22,20	25,80	25,80
		kcal/h	19.092	22.188	22.188
	Maximum heat output	kW	20,60	23,94	23,94
		kcal/h	17.717	20.590	20.590
	Minimum heat input	kW	7,00	8,90	8,90
		kcal/h	6.020	7.654	7.654
Minimum heat output	kW	5,88	7,61	7,61	
	kcal/h	5.057	6.544	6.544	
<b>DHW</b>	Heat input	kW	22,20	25,80	-
		kcal/h	19.092	22.188	-
	Maximum heat output	kW	20,60	23,94	-
		kcal/h	17.717	20.590	-
	Minimum heat input	kW	7,00	8,90	-
		kcal/h	6.020	7.654	-
Minimum heat output	kW	5,88	7,61	-	
	kcal/h	5.057	6.544	-	
Useful efficiency (Pn max - Pn min)		%	92,8 - 84,0	92,8 - 85,5	92,8 - 85,5
Efficiency 30% (47° return)		%	91,9	90,9	90,9
Combustion performance		%	93,2	93,0	93,0
Electric power		W	100	116	116
Category			II2H3+	II2H3+	II2H3+
Country of destination **			-	-	-
Power supply voltage		V - Hz	230-50	230-50	230-50
Degree of Protection		IP	X5D	X5D	X5D
Pressure drops on flue with burner on		%	6,85	6,96	6,96
Pressure drops on flue with burner off		%	0,09	0,07	0,07
<b>Heating operation</b>					
Pressure - maximum temperature		bar-°C	3 - 90	3 - 90	3 - 90
Minimum pressure for standard operation		bar	0,25 - 0,45	0,25 - 0,45	0,25 - 0,45
Selection field of heating water temperature		°C	40/80	40/80	40/80
Pump: maximum head available		mbar	300	300	300
for system capacity		l/h	1.000	1.000	1.000
Membrane expansion tank		l	7	8	8
Expansion tank pre-charge		bar	1	1	1
<b>DHW operation</b>					
Maximum pressure		bar	6	6	-
Minimum pressure		bar	0,15	0,15	-
Hot water quantity with $\Delta t$ 25°C		l/min	11,8	13,7	-
with $\Delta t$ 30°C		l/min	9,8	11,4	-
with $\Delta t$ 35°C		l/min	8,4	9,8	-
DHW minimum output		l/min	2	2	-
Selection field of DHW temperature		°C	37/60	37/60	-
Flow regulator		l/min	8	10	-
<b>Gas pressure</b>					
Methane gas nominal pressure (G20)		mbar	20	20	20
LPG liquid gas nominal pressure (G30/G31)		mbar	28-30/37	28-30/37	28-30/37
<b>Hydraulic connections</b>					
Heating input - output		Ø	3/4"	3/4"	3/4"
DHW input-output		Ø	1/2"	1/2"	-
Water tank delivery - output		Ø	-	-	3/4"
Gas input		Ø	3/4"	3/4"	3/4"
<b>Boiler dimensions</b>					
Height		mm	715	715	715
Width		mm	405	405	405
Depth of housing		mm	248	248	248
Boiler weight		kg	29	31	28
<b>Flow rate (G20)</b>					
Air capacity		Nm <sup>3</sup> /h	36,875	39,613	39,613
Flue gas capacity		Nm <sup>3</sup> /h	39,101	42,204	42,204
Mass flow of flue gas (max-min)		gr/s	13,310 - 14,540	14,308-16,247	14,308-16,247
<b>Flow rate (G30)</b>					
Air capacity		Nm <sup>3</sup> /h	35,328	40,249	40,249
Flue gas capacity		Nm <sup>3</sup> /h	36,955	41,008	41,008
Mass flow of flue gas (max-min)		gr/s	13,100 - 14,030	13,985 - 16,429	13,985 - 16,429

DESCRIPTION			CIAO 20 S C.S.I.	CIAO 24 S C.S.I.	CIAO 24 S R.S.I.
<b>Flow rate (G31)</b>					
Air capacity	Nm <sup>3</sup> /h		36,405	40,454	40,454
Flue gas capacity	Nm <sup>3</sup> /h		38,119	41,455	41,455
Mass flow of flue gas (max-min)	gr/s		13,480 - 14,280	14,120 - 16,683	14,120 - 16,683
<b>Fan performance</b>					
Residual head of boiler without pipes	Pa		43	110	110
<b>Concentric flue gas discharge pipes</b>					
Diameter	mm		60-100	60 - 100	60 - 100
Maximum length	m		4,25	4,25	4,25
Drop due to insertion of a 45°/90° bend	m		1 - 1,5	1 - 1,5	1 - 1,5
Hole in wall (diameter)	mm		105	105	105
<b>Concentric flue gas discharge pipes</b>					
Diameter	mm		80-125	80-125	80-125
Maximum length	m		12,40	12,4	12,4
Losses for a 45°/90° bend	m		1,35 - 2,2	1,35 - 2,2	1,35 - 2,2
Hole in wall (diameter)	mm		130	130	130
<b>Separate flue gas discharge pipes</b>					
Diameter	mm		80	80	80
Maximum length	m		10 + 10	16 + 16	16 + 16
Losses for a 45°/90° bend	m		1,2 - 1,7	1,2 - 1,7	1,2 - 1,7
<b>Installation B22P-B52P</b>					
Diameter	mm		80	80	80
Maximum length of drainage pipe	m		14	25	25
NOx class			3	3	3
<b>Emission values at max. and min. rate of gas G20*</b>					
Maximum - Minimum	CO s.a. less than	ppm	100 - 180	120 - 200	120 - 200
	CO <sub>2</sub>	%	7,1 - 2,0	7,3 - 2,2	7,3 - 2,2
	NOx s.a. lower than	ppm	180 - 100	200 - 100	200 - 100
	Flue gas temperature	°C	127 - 97	142 - 109	142 - 109

\* Check performed with concentric pipe ø 60-100, length 0.85m - water temperature 80-60°C

\*\* The installation of this product is allowed only in the destination Countries contained in the data plate, regardless of the present translation language.

### Multigas table

DESCRIPTION		Methane gas (G20)			Butane (G30)			Propane (G31)		
		20 S C.S.I.	24 S C.S.I.	24 S R.S.I.	20 S C.S.I.	24 S C.S.I.	24 S R.S.I.	20 S C.S.I.	24 S C.S.I.	24 S R.S.I.
Lower Wobbe index (at 15°C-1013 mbar)	MJ/m <sup>3</sup> S		45,67			80,58				70,69
Net Calorific Value	MJ/m <sup>3</sup> S		34,02			116,09				88
Supply nominal pressure	mbar (mm W.C.)		20 (203,9)			28 - 30 (285,5 - 305,9)				37 (377,3)
Supply minimum pressure	mbar (mm W.C.)		13,5 (137,7)			-				-
Burner (number of holes)	n°		11			11				11
Burner (diameter of holes)	mm	1,30	1,35	1,35	0,75	0,78	0,78	0,75	0,78	0,78
Heating maximum gas capacity	Sm <sup>3</sup> /h	2,35	2,73	2,73						
	kg/h				1,75	2,03	2,03	1,72	2,00	2,00
DHW maximum gas capacity	Sm <sup>3</sup> /h	2,35	2,73	-						
	kg/h				1,75	2,03	-	1,72	2,00	-
Heating minimum gas capacity	Sm <sup>3</sup> /h	0,74	0,94	0,94						
	kg/h				0,55	0,70	0,70	0,54	0,69	0,69
DHW minimum gas capacity	Sm <sup>3</sup> /h	0,74	0,94	-						
	kg/h				0,55	0,70	-	0,54	0,69	-
Maximum pressure downstream CH valve	mbar	10,40	11,80	11,80	28,00	27,80	27,80	36,00	35,80	35,80
	mm W.C.	106,05	120,33	120,33	285,52	283,48	283,48	367,10	365,06	365,06
Maximum pressure downstream DHW valve	mbar	10,40	11,80	-	28,00	27,80	-	36,00	35,80	-
	mm W.C.	106,05	120,33	-	285,52	283,48	-	367,10	365,06	-
Minimum pressure downstream CH valve	mbar	1,20	1,50	1,50	3,00	3,30	3,30	3,90	4,30	4,30
	mm W.C.	12,24	15,30	15,30	30,59	33,65	33,65	39,77	43,85	43,85
Minimum pressure downstream DHW valve	mbar	1,20	1,50	-	3,00	3,30	-	3,90	4,30	-
	mm W.C.	12,24	15,30	-	30,59	33,65	-	39,77	43,85	-

# F INSTALLATEUR

## 1 - AVERTISSEMENTS ET SÉCURITÉS

 Les chaudières produites dans nos établissements sont fabriquées en faisant attention aussi à chaque composant de manière à protéger tant l'utilisateur que l'installateur face à d'éventuels accidents. Donc, après toute intervention sur le produit, il est conseillé au personnel qualifié de prêter une attention particulière aux branchements électriques, surtout en ce qui concerne la partie des conducteurs dépourvue d'enveloppe, qui ne doit en aucune façon sortir du bornier, en évitant ainsi le contact possible avec les parties actives du conducteur.

 Le présent manuel d'instructions, avec celui de l'utilisateur, fait partie intégrante du produit : s'assurer qu'il accompagne toujours l'appareil, même en cas de transfert à un autre propriétaire ou utilisateur ou bien de déplacement sur une autre installation. En cas de dommage ou perte, demander une autre copie au Service après-vente local.

 L'installation de la chaudière et toute autre intervention d'assistance et d'entretien doivent être effectuées par du personnel qualifié selon les dispositions des normes locales et nationales en vigueur.

 Il est conseillé à l'installateur d'informer l'utilisateur sur le fonctionnement de l'appareil et sur les règles fondamentales de sécurité.

 Cette chaudière ne peut s'utiliser que pour l'application pour laquelle elle a été conçue. Le fabricant décline toute responsabilité contractuelle et non contractuelle en cas de blessures à des personnes ou des animaux ou en cas de dommages aux biens dérivés d'erreurs d'installation, de réglage ou d'entretien, ou d'une utilisation inappropriée.

 Une fois l'emballage enlevé, s'assurer que le contenu est complet et en bon état. En cas de non conformité, s'adresser au revendeur où l'appareil a été acheté.

 L'évacuation de la soupape de sécurité de l'appareil doit être raccordée à un système de récolte et d'évacuation approprié. Le constructeur de l'appareil décline toute responsabilité pour d'éventuels dommages provoqués par l'intervention de la soupape de sécurité.



 Éliminer les matériaux d'emballage dans les récipients appropriés auprès des centres de ramassage correspondants.

 Les déchets doivent être éliminés sans danger pour la santé de l'homme et sans utiliser des procédures ou des méthodes qui pourraient endommager l'environnement.







Lors de l'installation, il est nécessaire d'informer l'utilisateur que :

- en cas de fuites d'eau, il faut couper l'alimentation en eau et avertir immédiatement le Service après-vente
- la pression d'exercice du système hydraulique doit être entre 1 et 2 bar, et par conséquent, ne pas dépasser 3 bar. Si nécessaire, réarmer la pression comme indiqué dans le paragraphe intitulé « Remplissage du système »
- en cas de ne pas utiliser la chaudière pendant une longue période, il est conseillé de faire intervenir le Service après-vente pour effectuer au moins les opérations suivantes :
  - positionner l'interrupteur principal de l'appareil et l'interrupteur général de l'installation sur « off »
  - fermer les robinets du combustible et de l'eau, tant de l'installation thermique que sanitaire
  - en cas de risque de gel, vidanger les installations thermique et sanitaire
- l'entretien de l'appareil doit être effectué au moins une fois par an. Cet entretien devra être accordé au préalable avec le Service technique après-vente.

En ce qui concerne la sécurité, il faut rappeler ce qui suit :

-  les enfants et les personnes inexpérimentées sans assistance ne doivent pas utiliser la chaudière.
-  il est dangereux d'activer des dispositifs ou des appareils électriques, tels que des interrupteurs, des appareils électroménagers,

etc. en cas de sentir le combustible ou la combustion. en cas de fuites de gaz, aérer la pièce en ouvrant complètement les portes et les fenêtres, fermer le robinet général à gaz, faire intervenir immédiatement le personnel qualifié du Service après-vente

-  ne pas toucher la chaudière avec les pieds nus et des parties du corps mouillées ou humides
-  avant d'effectuer le nettoyage, débrancher la chaudière du réseau de distribution électrique en positionnant l'interrupteur bipolaire de l'installation et l'interrupteur principal du panneau de commande sur « OFF »
-  il est interdit de modifier les dispositifs de sécurité ou de réglage sans l'autorisation ou les indications du constructeur
-  ne pas tirer, détacher, retordre les câbles électriques sortant de la chaudière, même si celle-ci est débranchée du réseau de distribution électrique
-  éviter de boucher ou de réduire les dimensions des ouvertures d'aération de la pièce où se trouve l'installation
-  ne pas laisser des récipients ni de substances inflammables dans la pièce où l'appareil est installé
-  ne pas laisser les éléments constituant l'emballage à la portée des enfants.

## 2 - DESCRIPTION DE LA CHAUDIÈRE

**Ciao S C.S.I.** est une chaudière murale de type C pour le chauffage et la production d'eau chaude sanitaire : selon l'accessoire d'évacuation des fumées utilisé, la chaudière est classée dans les catégories B22P, B52P, C12, C22, C32, C42, C52, C62, C82, C92, C12x, C32x, C42x, C52x, C62x, C82x, C92x.

**Ciao S R.S.I.** est une chaudière murale de type C fonctionnant selon différents modes :

### CAS A

chauffage uniquement sans branchement à un chauffe-eau extérieur. La chaudière ne fournit pas d'eau chaude sanitaire.

### CAS B

chauffage uniquement avec branchement à un chauffe-eau extérieur à commande thermostatique: dans cette condition, avec toute demande de chaleur du thermostat du chauffe-eau, la chaudière fournit de l'eau chaude pour la préparation de l'eau chaude sanitaire.

### CAS C

chauffage seul avec un chauffe-eau extérieur raccordé (kit accessoire disponible sur demande) (géré par une sonde de température) pour la préparation de l'eau chaude sanitaire. Lors du branchement du chauffe-eau non fourni par notre société, s'assurer que la sonde NTC dispose des caractéristiques suivantes: 10 kOhm à 25°C, B 3435 ±1%

Dans la configuration B22P et B52P (en cas d'installation à l'intérieur), l'appareil ne peut pas être installé dans des pièces utilisées comme chambre à coucher, salle de bain, douche ou possédant des cheminées ouvertes sans afflux d'air. La pièce où la chaudière sera installée devra avoir une ventilation appropriée.

Dans la configuration C, l'appareil peut être installé dans n'importe quel type de pièce car il n'existe aucune limite quant aux conditions d'aération et au volume de la pièce.

## 3 - RÈGLES D'INSTALLATION

### 3.1 - Normes pour l'installation

L'installation doit être effectuée par du personnel qualifié.

En outre, il faut toujours respecter les dispositions nationales et locales.



### EMPLACEMENT

**Ciao S** peut être installé en intérieur (fig. 2).

La chaudière est pourvue de protections qui garantissent son fonctionnement correct avec une plage de température de 0 °C à 60 °C.

Pour bénéficier des protections, l'appareil doit être en conditions de s'allumer, car toute condition de blocage (par ex. absence de gaz ou d'alimentation électrique, ou bien l'intervention d'un dispositif de sécurité) désactive les protections.

Dans certaines parties du manuel on utilise les symboles :

-  ATTENTION = actions demandant une certaine prudence et une préparation adéquate
-  INTERDICTION = actions NE DEVANT absolument PAS être exécutées

**DISTANCES MINIMUM**

Pour accéder à l'intérieur de la chaudière afin d'effectuer les opérations d'entretien normales, il est nécessaire de respecter les espaces minimaux prévus pour l'installation (Fig. 3).

Pour un positionnement correct de l'appareil, ne pas oublier que :

- il ne doit pas être positionné sur une cuisinière ou un autre appareil de cuisson;
- il est interdit de laisser des substances inflammables dans la pièce où la chaudière est installée;
- les murs sensibles à la chaleur (par exemple ceux en bois) doivent être protégés à l'aide d'une isolation convenable.

**IMPORTANT**

Avant l'installation, il est conseillé de laver soigneusement tous les tuyaux du système afin de retirer d'éventuels résidus qui pourraient compromettre le bon fonctionnement de l'appareil.

Installer au-dessous de la soupape de sécurité un entonnoir de récolte d'eau avec le dispositif d'évacuation correspondant en cas de fuite par surpression de l'installation de chauffage. Le circuit de l'eau sanitaire n'a pas besoin de soupape de sécurité, mais il faut s'assurer que la pression du conduit d'eau ne dépasse pas 6 bars. En cas de doute, il sera convenable d'installer un réducteur de pression.

Avant l'allumage, s'assurer que la chaudière est prévue pour fonctionner avec le gaz disponible ceci peut être repéré dans l'inscription sur l'emballage et dans l'étiquette adhésive reportant le type de gaz.

Il est très important de signaler que dans certains cas les conduits de fumées sont sous pression, donc les jonctions de plusieurs éléments doivent être hermétiques.

**SYSTÈME ANTIGEL**

La chaudière est équipée de série d'un système antigel automatique qui s'active lorsque la température de l'eau du circuit primaire est inférieure à 6 °C. Ce système est toujours actif et il garantit la protection de la chaudière jusqu'à une température extérieure de -3 °C. Pour profiter de cette protection (par rapport au fonctionnement du brûleur), la chaudière doit être en mesure de s'allumer elle seule ; cela signifie que toute condition de blocage (ex. manque de gaz ou d'alimentation électrique, ou encore déclenchement d'un dispositif de sécurité) désactive la protection.

La protection antigel est active même lorsque la chaudière est en état de veille. Dans des conditions normales de fonctionnement, la chaudière est capable de s'autoprotéger du gel. Au cas où l'appareil serait laissé longtemps hors tension dans des zones soumises à des températures inférieures à 0 °C et qu'on ne souhaiterait pas vidanger l'installation de chauffage, il est conseillé d'utiliser un liquide antigel de qualité dans le circuit primaire. Suivre attentivement les instructions du fabricant concernant non seulement le pourcentage de liquide antigel à utiliser pour la température minimale à laquelle vous souhaitez maintenir le circuit de la machine mais également la durée et le mode d'élimination du liquide antigel.

Pour la partie sanitaire, il est conseillé de vider le circuit. Les matériaux utilisés pour la fabrication des composants des chaudières sont résistants aux liquides antigel à base de glycols éthyléniques.

**3.2 Fixation de la chaudière au mur et raccords hydrauliques**

Pour fixer la chaudière au mur, utiliser le gabarit en carton (Fig. 4-5) présent dans l'emballage. La position et la dimension des raccords hydrauliques sont reportées en détail :

<b>A</b>	Retour chauffage	3/4"
<b>B</b>	Refoulement chauffage	3/4"
<b>C</b>	Raccordement gaz	3/4"
<b>D</b>	Sortie ECS	1/2" (pour C.S.I.) - 3/4" (pour R.S.I.)
<b>E</b>	Entrée ECS	1/2" (pour C.S.I.) - 3/4" (pour R.S.I.)

En cas de remplacement de chaudières Beretta de la gamme précédente, un kit d'adaptation des raccords hydrauliques est disponible.

**3.3 Branchement électrique**

Les chaudières sortent de l'usine complètement câblées avec le câble d'alimentation électrique déjà branché et elles n'ont besoin que du branchement du thermostat d'ambiance (TA) aux bornes dédiées.

Pour accéder au bornier :

- Couper l'interrupteur général du système
- dévisser les vis (A) de fixation du manteau (Fig. 6)
- déplacer vers l'avant et ensuite vers le haut la base du manteau pour le décrocher du cadre
- dévisser la vis de fixation (B) du tableau de bord (Fig. 7)
- tourner le tableau de bord vers soi
- déposer la couverture du bornier (Fig. 8)
- insérer le câble de l'éventuel T.A. (Fig. 9)

Le thermostat d'ambiance doit être branché comme indiqué sur le schéma électrique.

**⚠ Entrée du thermostat d'ambiance à basse tension de sécurité (24 Vcc).**

Le branchement au réseau électrique doit être réalisé par un dispositif de séparation avec ouverture omnipolaire d'au moins 3,5 mm (EN 60335-1, catégorie III).

L'appareil fonctionne en courant alternatif de 230 V/50 Hz, il a une puissance électrique de 100 W pour 20 C.S.I. - 115 W pour 24 C.S.I. et 24 R.S.I. (conforme à la norme EN 60335-1).

**⚠** Le branchement avec une installation de mise à la terre efficace est obligatoire, conformément aux normes nationales et locales en vigueur.

**⚠** Il est conseillé de respecter le branchement de phase neutre (L-N).

**⚠** Le conducteur de terre doit être deux centimètres plus long que les autres.

**⚠ L'utilisation des tuyaux de gaz et/ou d'eau comme mise à la terre d'appareils électriques est interdite.**

Le constructeur décline toute responsabilité pour d'éventuels dommages provoqués par l'absence de mise à la terre de l'installation.

Pour le branchement électrique, utiliser le **câble d'alimentation fourni**.

**En cas de remplacement du câble d'alimentation, utiliser un câble du type HAR H05V2V2-F, 3 x 0,75 mm<sup>2</sup>, diamètre max. externe 7 mm.**

**3.4 Raccordement de gaz**

Avant d'effectuer le raccordement de l'appareil au réseau de gaz, vérifier que :

- les normes d'installation nationales et locales ont été respectées
- le type de gaz est celui pour lequel l'appareil a été prévu
- les tuyaux sont propres.

La canalisation de gaz prévue est externe. Si le tuyau traversait le mur il devrait passer à travers le trou central de la partie inférieure du gabarit. Il est conseillé d'installer un filtre de dimensions appropriées sur la ligne de gaz au cas où le réseau de distribution contiendrait des particules solides. Une fois l'installation effectuée, vérifier si les jonctions réalisées sont étanches comme prévu par les règles d'installation en vigueur.

**3.5 Évacuation des produits de combustion et aspiration de l'air**

Pour l'évacuation des produits de combustion, consulter les normes locales et nationales en vigueur. En outre, il faut toujours respecter les normes locales des sapeurs-pompiers, de la compagnie du gaz et les éventuelles dispositions municipales.

L'évacuation des produits de combustion est assurée par un ventilateur placé à l'intérieur de la chambre de combustion dont le fonctionnement correct est contrôlé constamment par un pressostat. La chaudière est fournie sans le kit d'évacuation des fumées/aspiration d'air, car il est possible d'utiliser les accessoires pour des appareils à chambre étanche à tirage forcé qui mieux s'adaptent aux caractéristiques typologiques d'installation. Pour l'extraction des fumées et le rétablissement de l'air comburant de la chaudière, il est indispensable que des tuyaux certifiés soient employés et que le raccordement soit effectué correctement, tel qu'il est indiqué dans les instructions fournies avec les accessoires pour fumées.

Il est possible de raccorder plusieurs appareils à un conduit de fumées unique, à condition qu'ils soient tous du type à chambre étanche.

**INSTALLATION À OUVERTURE FORCÉE (B22P-B52P)****Conduit de sortie des fumées Ø 80 mm (fig. 10a)**

Le conduit de sortie des fumées peut être orienté dans le sens le plus approprié selon les exigences d'installation. Pour l'installer, suivre les instructions fournies avec le kit.

**⚠** Dans cette configuration, la chaudière est connectée au conduit de sortie des fumées de Ø 80 mm au moyen d'un adaptateur de Ø 60-80 mm.

Dans ce cas, l'air comburant est aspiré de la pièce dans laquelle la chaudière est installée, laquelle doit être un local technique approprié et bien aéré.

**⚠** Les conduits de sortie des fumées non isolés sont des sources potentielles de danger.

Lorsqu'il est nécessaire, la bride fumées (F) doit être retirée en faisant levier avec un tournevis.

La chaudière adapte automatiquement la ventilation au type d'installation et à la longueur du conduit.

**20 C.S.I.**

Longueur des conduits Ø 80 [m]	Bride de fumées (F)	Pertes de charge de chaque coude (m)	
		45°	90°
jusqu'à 1,5	Ø 39	1,2	1,7
de 1,5 à 5	Ø 41 (**)		
de 5 à 14	Ø 43		

(\*\*) montée dans la chaudière

24 C.S.I. - 24 R.S.I.

Longueur des conduits Ø 80 [m]	Bride de fumées (F)	Pertes de charge de chaque coude (m)	
		45°	90°
jusqu'à 2	Ø 42	1,2	1,7
de 2 à 8	Ø 44 (**)		
de 8 à 25	non installée		

(\*\*) montée dans la chaudière

ÉVACUATIONS CONCENTRIQUES (Ø 60-100)

La chaudière est prévue pour être raccordée à des conduits d'évacuation/aspiration concentriques et avec l'ouverture pour l'aspiration d'air (E) fermée (Fig. 10b). Les évacuations concentriques peuvent être orientées dans la direction la plus adaptée aux exigences de la pièce, en respectant les longueurs maximum reportées dans le tableau. Pour l'installation, suivre les instructions fournies avec le kit.

Selon la longueur de conduits utilisée, il sera nécessaire d'insérer une bride en la choisissant parmi celles contenues dans la chaudière (voir les tableaux reportés tout de suite). Si nécessaire, la bride fumées (F) doit être retirée en faisant levier avec un tournevis. Le tableau reporte les longueurs rectilignes admises. Selon la longueur de conduits utilisée, il sera nécessaire d'insérer une bride en la choisissant parmi celles contenues dans la chaudière (voir les tableaux reportés tout de suite).

20 C.S.I.

Longueur des conduits [m]	Bride de fumées (F)	Pertes de charge de chaque coude (m)	
		45°	90°
jusqu'à 0,85	Ø 39	1	1,5
de 0,85 à 2,35	Ø 41 (**)		
de 2,35 à 4,25	Ø 43		

(\*\*) montée dans la chaudière

24 C.S.I. - 24 R.S.I.

Longueur des conduits [m]	Bride de fumées (F)	Pertes de charge de chaque coude (m)	
		45°	90°
jusqu'à 0,85	Ø 42	1	1,5
de 0,85 à 2,35	Ø 44 (**)		
de 2,35 à 4,25	non installée		

(\*\*) montée dans la chaudière

Conduits concentriques (Ø 80/125)

La chaudière est prévue pour être raccordée à des conduits d'évacuation/aspiration coaxiaux et avec l'ouverture pour l'aspiration d'air fermée. Les évacuations coaxiales peuvent être orientées dans la direction la plus adaptée aux exigences de la pièce, en respectant les longueurs maximum reportées dans le tableau.

Pour l'installation, suivre les instructions fournies avec le kit. Pour traverser le mur, réaliser un trou de Ø 140 mm. Selon la longueur de conduits utilisée, il sera nécessaire d'insérer une bride en la choisissant parmi celles contenues dans la chaudière (voir le tableau). Prêter une attention particulière à la température extérieure et à la longueur du conduit. Se référer aux graphiques pour établir l'obligation ou non d'utiliser le bac de condensants. En cas de fonctionnement de la chaudière à des températures inférieures à 60 °C, l'utilisation du bac de condensats est obligatoire. En cas d'utilisation d'un bac de condensats, prévoir une inclinaison du conduit d'évacuation des fumées de 1 % vers le bac.

Raccorder le siphon du bac de condensats à un conduit d'évacuation des eaux blanches.

Les conduits d'évacuation non isolés constituent des sources potentielles de danger.

20 C.S.I.

Longueur des conduits Ø 80 125 [m]	Bride de fumées (F)	Pertes de charge de chaque coude (m)	
		45°	90°
de 0,96 à 3,85	Ø 39	1,35	2,2
de 3,85 à 7,85	Ø 41 (**)		
de 7,85 à 12,40	Ø 43		

(\*\*) montée dans la chaudière

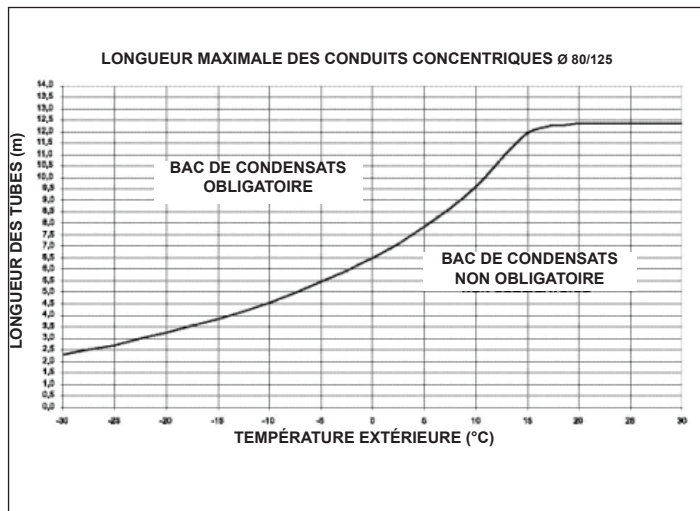

kit coude coaxial baissé

⚠ Au cas où il serait nécessaire d'installer l'unité Ciao S sur des installations déjà existantes (remplacement des gammes Ciao N/Mynute), le « kit coude coaxial baissé » est disponible pour permettre de poser la chaudière en conservant le même trou de sortie des fumées.

Longueur des conduits avec coude baissé [m]	Bride de fumées (F)		Pertes de charge de chaque coude (m)	
	Ciao S 20 C.S.I.	Ciao S 24 C.S.I.	45°	90°
jusqu'à 1,85	Ø 41	Ø 44	1	1,5
de 1,85 à 4,25	Ø 43	aucune bride		

24 C.S.I. - 24 R.S.I.

Longueur des conduits Ø 80 125 [m]	Bride de fumées (F)	Pertes de charge de chaque coude (m)	
		45°	90°
de 0,96 à 3,85	Ø 42	1,35	2,2
de 3,85 à 7,85	Ø 44 (**)		
de 7,85 à 12,4	non installée		

(\*\*) montée dans la chaudière



**ÉVACUATIONS DÉDOUBLÉES (ø 80) (fig. 11)**

Les évacuations dédoublées peuvent être orientées dans la direction la plus adaptée aux exigences de la pièce.

Pour utiliser le tuyau d'aspiration d'air comburant, sélectionner l'une des deux entrées (G et H). Retirer le bouchon de fermeture fixé à l'aide de vis et utiliser l'adaptateur spécifique relatif à l'entrée sélectionnée.

! L'adaptateur d'entrée d'air ø 80 (X) doit être orienté convenablement, il est donc nécessaire de le fixer à l'aide des vis appropriées, de manière à ce que la patte de positionnement n'interfère avec le capot : X adaptateur d'entrée d'air ø 80 - Y adaptateur d'entrée d'air de ø 60 à ø 80.

Si nécessaire, la bride fumées (F) doit être retirée en faisant levier avec un tournevis. Le tableau reporte les longueurs rectilignes admises. Selon la longueur de conduits utilisée, il sera nécessaire d'insérer une bride en la choisissant parmi celles contenues dans la chaudière (voir les tableaux reportés tout de suite).

**20 C.S.I.**

Longueur des conduits [m]	Bride de fumées (F)	Pertes de charge de chaque coude (m)	
		45°	90°
1+1	Ø 39	1,2	1,7
> 1+1 ÷ 4+4	Ø 41 (**)		
> 4+4 ÷ 10+10	Ø 43		

(\*\*) montée dans la chaudière

**24 C.S.I. - 24 R.S.I.**

Longueur des conduits [m]	Bride de fumées (F)	Pertes de charge de chaque coude (m)	
		45°	90°
2+2	Ø 42	1,2	1,7
>2+2 ÷ 6+6	Ø 44 (**)		
>6+6 ÷ 16+16	non installée		

(\*\*) montée dans la chaudière

**3.6 Remplissage de l'installation de chauffage (Fig. 13)**

Une fois les raccords hydrauliques réalisés, il est possible de remplir l'installation de chauffage. Cette opération doit être réalisée avec l'installation froide en effectuant les opérations suivantes :

- ouvrir le bouchon du purgeur d'air automatique (I) en effectuant deux ou trois tours
- s'assurer que le robinet d'entrée d'eau froide est ouvert;
- tourner le robinet de remplissage (L fig. 13 pour C.S.I. - extérieur pour R.S.I.) jusqu'à ce que la pression indiquée par le manomètre soit comprise entre 1 et 1,5 bar.

Une fois le remplissage fini, refermer le robinet de remplissage.

La chaudière est dotée d'un séparateur d'air, en conséquence aucune opération manuelle n'est demandée. Le brûleur s'allume uniquement si la phase de purge de l'air est finie.

**3.7 Vidange de l'installation de chauffage**

Pour vidanger l'installation, procéder comme suit :

- éteindre la chaudière
- desserrer le robinet de vidange de la chaudière (M)
- vidanger les points les plus bas de l'installation.

**3.8 Purge de l'eau chaude sanitaire (uniquement pour modèle C.S.I.)**

En cas de risque de gel, l'installation sanitaire doit être vidangée en procédant comme suit :

- fermer le robinet général du réseau de distribution d'eau
- ouvrir tous les robinets de l'eau chaude et froide
- vidanger les points les plus bas.

**ATTENTION**

L'évacuation de la soupape de sécurité (N) doit être raccordée à un système de récolte approprié. Le constructeur de l'appareil décline toute responsabilité pour d'éventuelles inondations provoquées par l'intervention de la soupape de sécurité.

**B22P/B52P Aspiration intérieure et évacuation extérieure**

**C12-C12x** Évacuation via refoulement mural concentrique. Les tuyaux peuvent partir indépendamment de la chaudière, mais les sorties doivent être concentriques ou suffisamment rapprochées pour être sujettes à des conditions de vent similaires (en moins de 50 cm)

**C22** Évacuation concentrique dans un conduit de fumées commun (aspiration et évacuation dans le même conduit)

**C32-C32x** Évacuation via refoulement concentrique au plafond. Refoulements comme pour C13

**C42-C42x** Évacuation et aspiration dans des conduits de fumées communs séparés, mais soumis à des conditions de vent similaires

**C52-C52x** Évacuation et aspiration séparées murales ou au plafond et en zones avec des pressions différentes. Les tuyaux de refoulement et d'aspiration ne doivent jamais être placés sur les murs opposés

**C62-C62x** Tuyaux de refoulement et d'aspiration vendus et certifiés séparément (1856/1)

**C82-C82x** Refoulement via conduit de fumées traditionnel et tuyau d'aspiration mural

**C92-C92x** Refoulement au plafond (similaire à C33) et aspiration d'air par un conduit de fumées simple

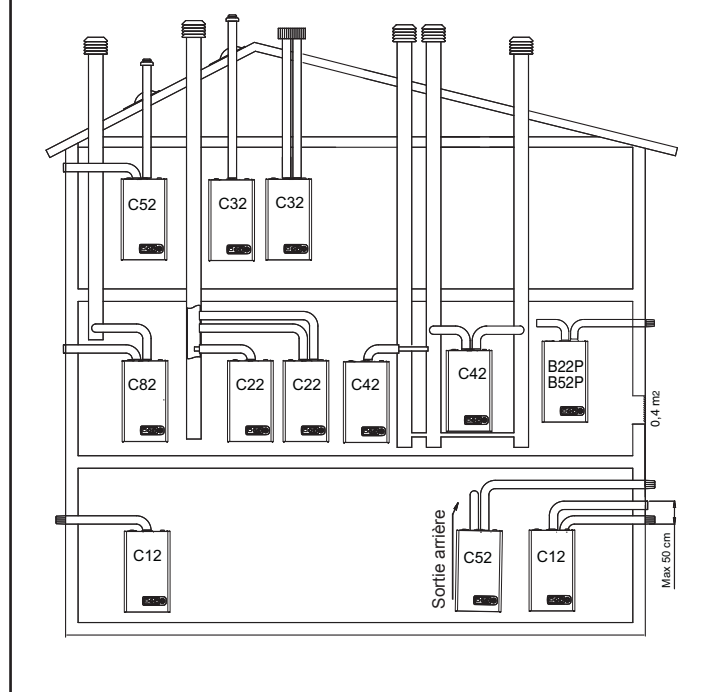

## 4 ALLUMAGE ET FONCTIONNEMENT

### 4.1 Vérifications préliminaires

Le premier allumage est effectué par du personnel compétent d'un Service après-vente Beretta agréé.

Avant de démarrer la chaudière, faire vérifier :

- que les données des réseaux de distribution (électrique, d'eau, de gaz) sont conformes à celles de la plaque
- que les tuyaux partant de la chaudière sont recouverts d'une gaine calorifuge
- que les conduits d'évacuation des fumées et d'aspiration d'air sont efficaces;
- que les conditions pour les entretiens normaux sont garanties au cas où la chaudière serait renfermée dans ou entre les meubles
- l'étanchéité du système d'amenée du combustible
- que le débit du combustible est conforme aux valeurs demandées par la chaudière
- que les dimensions de l'installation d'alimentation en combustible correspondent au débit nécessaire à la chaudière et que cette installation est dotée de tous les dispositifs de sécurité et de contrôle prescrits par les normes en vigueur.

### 4.2 Allumage de l'appareil



Pour allumer la chaudière, il faut effectuer les opérations suivantes :

- mettre la chaudière sous tension;
- ouvrir le robinet de gaz présent sur l'installation afin de permettre le flux du combustible;
- tourner le sélecteur de fonction (1 - fig. 1a) sur la position souhaitée :

**Ciao S C.S.I.:**

**Mode été :** en tournant le sélecteur sur le symbole été «  » (Fig. 2a) la fonction traditionnelle d'eau chaude sanitaire uniquement s'active. En cas de demande d'eau chaude sanitaire l'écran numérique affiche la température de l'installation d'eau chaude, l'icône servant à indiquer l'alimentation en eau chaude et l'icône flamme

**Mode hiver :** en tournant le sélecteur de fonction dans la zone marqué + et - (Fig. 2b), la chaudière fournit de l'eau chaude et du chauffage. En cas de demande de chaleur, la chaudière s'allume et l'écran numérique affiche la température de l'eau chaude, l'icône indiquant le chauffage et l'icône flamme (fig. 3a). En cas de demande d'eau chaude sanitaire, la chaudière s'allume et l'écran numérique affiche la température de l'eau chaude, l'icône indiquant l'alimentation en eau chaude et l'icône flamme (fig. 4a)

**Préchauffage (eau chaude plus rapidement) :** Tourner à nouveau la poignée de réglage de la température de l'eau sanitaire (2 - fig. 1a) sur le symbole  (fig. 5a), pour désactiver la fonction préchauffage. Cette fonction permet de maintenir chaude l'eau contenue dans l'échangeur sanitaire afin de réduire les temps d'attente durant les prélèvements. Lorsque la fonction préchauffage est activée, l'afficheur indique la température de refoulement de l'eau de chauffage ou de l'eau sanitaire sur la base de la demande en cours. Lors de l'allumage du brûleur, suite à une demande de préchauffage, l'afficheur montre le symbole **P** (fig. 5b). Pour désactiver la fonction préchauffage, tourner à nouveau la poignée de réglage de la température de l'eau sanitaire sur le symbole . Mettre alors la poignée de réglage de la température de l'eau sanitaire dans la position souhaitée. La fonction est désactivée lorsque la chaudière est en état OFF : sélecteur de fonction (1 Fig. 1a) sur «  » éteint (OFF).

**Ciao S R.S.I.:**

**Mode été (uniquement avec le chauffe-eau extérieur branché) :** en tournant le sélecteur sur le symbole de mode été  (fig. 2a) on active la fonction traditionnelle eau chaude sanitaire uniquement, la chaudière produit de l'eau à la température réglée sur le chauffe-eau extérieur. En cas de demande d'eau chaude sanitaire l'écran numérique affiche la température de l'installation d'eau chaude, l'icône servant à indiquer l'alimentation en eau chaude et l'icône flamme

**Mode hiver :** en tournant le sélecteur de fonction dans la zone marqué + et - (Fig. 2b), la chaudière fournit de l'eau chaude pour le chauffage et - si branchée au chauffe-eau extérieur- de l'eau chaude sanitaire. En cas de demande de chaleur, la chaudière s'allume et l'écran numérique affiche la température de l'eau chaude, l'icône indiquant le chauffage et l'icône flamme (fig. 3a). En cas de demande d'eau chaude sanitaire, la chaudière s'allume et l'écran numérique affiche la température de l'eau chaude, l'icône indiquant l'alimentation en eau chaude et l'icône flamme (fig. 4a).

Régler le thermostat d'ambiance à la température souhaitée (~20 °C)

### Ciao S C.S.I. : Réglage de la température de l'eau chaude sanitaire

Pour régler la température de l'eau sanitaire (salles de bain, douches, cuisine, etc.), tourner la poignée avec le symbole «  » (Fig. 2b) dans la zone marquée + et -.

La chaudière reste en état stand-by, suite à une demande de chaleur, le brûleur s'allume et l'écran numérique affiche la température de l'eau chaude, l'icône indiquant l'alimentation en eau chaude et l'icône flamme. La chaudière restera en fonctionnement jusqu'à ce que les températures réglées soient atteintes, après quoi elle se remettra en stand-by.

Si la DEL lumineuse rouge s'allume sur le symbole «  » du panneau de commande, cela signifie que la chaudière est en état d'arrêt temporaire (voir le chapitre concernant les signaux lumineux et les anomalies). L'afficheur numérique montre le code d'anomalie détectée (Fig. 6a).

### Ciao S R.S.I. : Réglage de la température de l'eau chaude sanitaire

**CAS A** chauffage uniquement - le réglage n'est pas nécessaire

**CAS B** chauffage uniquement + chauffe-eau extérieur avec thermostat - le réglage n'est pas nécessaire.

**CAS C** chauffage uniquement + chauffe-eau extérieur avec sonde - pour régler la température de l'eau sanitaire stockée dans le chauffe-eau, tourner le sélecteur de température avec le symbole dans le sens des aiguilles d'une montre pour augmenter la température et dans le sens inverse pour l'abaisser.

La chaudière reste en état stand-by, suite à une demande de chaleur, le brûleur s'allume et l'écran numérique affiche la température de l'eau chaude, l'icône indiquant l'alimentation en eau chaude et l'icône flamme. La chaudière restera en fonctionnement jusqu'à ce que les températures réglées soient atteintes, après quoi elle se remettra en stand-by.

Si la DEL lumineuse rouge s'allume sur le symbole «  » du panneau de commande, cela signifie que la chaudière est en état d'arrêt temporaire (voir le chapitre concernant les signaux lumineux et les anomalies). L'afficheur numérique montre le code d'anomalie détectée (Fig. 6a)

### Ciao S C.S.I. - Ciao S R.S.I. : Fonction Système automatique de réglage de l'ambiance (S.A.R.A.) (Fig. 7a)

En plaçant le sélecteur de température de l'eau de chauffage dans la zone indiquée par l'inscription « AUTO » - valeur de température de 55 à 65 °C -, le système de réglage automatique S.A.R.A. s'active : la chaudière varie la température de refoulement en fonction du signal de fermeture du thermostat d'ambiance. Une fois atteinte la température réglée avec le sélecteur de température d'eau du chauffage, un comptage de 20 minutes commence. Si pendant cette période le thermostat d'ambiance continue à demander de la chaleur la valeur de la température réglée augmente de 5 °C automatiquement.

Une fois atteinte la nouvelle valeur réglée, un comptage de 20 minutes de plus commence.

Si pendant cette période le thermostat d'ambiance continue à demander de la chaleur la valeur de la température réglée augmente de 5 °C de plus automatiquement.

Cette nouvelle valeur de température est le résultat de la température réglée manuellement avec le sélecteur de température d'eau du chauffage et l'augmentation de +10 °C de la fonction S.A.R.A.



Suite au deuxième cycle, la température est à maintenir à la valeur +10°C prédéfinie jusqu'à ce que la demande du thermostat d'ambiance soit satisfaite.

### 4.3 Extinction

#### Extinction provisoire

En cas de courtes absences, positionner le sélecteur de fonction (1 - Fig. 1a) sur «  » (OFF).

De cette façon (en laissant l'alimentation électrique et l'alimentation en combustible activées), la chaudière est protégée par les systèmes suivants :

- **Fonction antigel :** quand la température d'eau de la chaudière descend en dessous de 5 °C, le circulateur et, au besoin, le brûleur sont activés à la puissance minimale pour reporter la température de l'eau à des valeurs de sécurité (35 °C). Au cours du cycle antigel, le symbole  apparaît sur l'afficheur numérique.
- **Fonction antiblocage du circulateur :** un cycle de fonctionnement est activé toutes les 24 heures.
- **Antigel d'eau chaude sanitaire (uniquement en cas de branchement à un chauffe-eau extérieur avec sonde) :** la fonction est activée si la température mesurée par la sonde du chauffe-eau descend en dessous de 5 °C. Une demande de chauffage est générée lors de cette phase avec l'allumage du brûleur à la puissance minimale, laquelle est maintenue jusqu'à ce que la température de l'eau atteigne 55° C. Au cours du cycle antigel, le symbole  apparaît sur l'afficheur numérique.





















### Extinction pendant de longues périodes

En cas de longues absences, positionner le sélecteur de fonction (1 - Fig. 1a) sur  (OFF).

Fermer ensuite le robinet de gaz présent sur l'installation. Dans ce cas, la fonction antigel est désactivée : vidanger les installations en cas de risque de gel.

### 4.4 Signaux lumineux et anomalies

L'état de fonctionnement de la chaudière est indiqué sur l'afficheur numérique, on retrouve plus bas les types d'affichage.

ÉTAT DE LA CHAUDIÈRE	AFFICHEUR
Stand-by	-
État OFF	OFF
Alarme de verrouillage du module ACF	A01  
Alarme de panne électrique ACF	A01  
Alarme de thermostat limite	A02 
Alarme de pressostat air	A03 
H2O Alarme de pressostat	A04  
NTC anomalie eau sanitaire (C.S.I. et R.S.I. uniquement avec réchauffeur d'accumulation extérieur à sonde)	A06 
NTC Anomalie de chauffage	A07 
Flamme parasite	A11 
Chauffage min et max réglage électrique	ADJ 
Transitoire en attente d'allumage	88°C clignotant
Intervention du pressostat air	 clignotant
H2O intervention du pressostat	  clignotant
Fonction de préchauffage active (uniquement C.S.I.)	P
Demande de préchauffage (uniquement C.S.I.)	P clignotant
Sonde extérieure présente	
Demande de chauffage eau sanitaire	60°C 
Demande de chauffage	80°C 
Demande de chaleur antigel	
Flamme présente	

#### Pour rétablir le fonctionnement (désactiver les alarmes):

##### Anomalies A 01-02-03



Placer le sélecteur de fonction sur  éteint (OFF), attendre 5-6 secondes puis le mettre dans la position souhaitée  (été) ou  (hiver).

Si les tentatives de déblocage ne réactivent pas la chaudière, demander l'intervention du Service après-vente.

##### Anomalie A 04

En plus du code d'anomalie, l'afficheur numérique visualise le symbole . Vérifier la valeur de la pression indiquée par l'indicateur du niveau d'eau:

Si elle est inférieure à 0,3 bars, placer le sélecteur de fonction sur  (OFF) et régler le bouchon de remplissage (L fig. 13 pour C.S.I. - extérieur pour R.S.I.) jusqu'à ce que la pression atteigne une valeur comprise entre 1 et 1,5 bar.

Placer ensuite le sélecteur de mode sur la position souhaitée  (été) ou  (hiver).

La chaudière effectuera un cycle de purge d'environ 2 minutes.

Si les chutes de pression sont fréquentes, demander l'intervention du service Technique Après-vente.

##### Anomalie A 06 (uniquement C.S.I.)

La chaudière fonctionne normalement, mais ne garantit pas la stabilité de la température de l'eau sanitaire, qui reste réglée autour d'une température de 50 °C. S'adresser au Service d'assistance technique.

##### Anomalie A 07

Demander l'intervention du Service après-vente.

### 4.5 Réglages

La chaudière a été réglée en usine par le constructeur.

Pourtant, s'il est nécessaire d'effectuer de nouveaux réglages, par exemple après des opérations d'entretien extraordinaire, après le remplacement du robinet du gaz ou après une transformation du gaz, suivre les procédures décrites tout de suite.

 **Les réglages de la puissance maximum doivent être effectués dans la séquence indiquée et exclusivement par du personnel qualifié.**

- déposer le manteau en dévissant les vis de fixation A (Fig. 6)
- dévisser d'environ deux tours la vis de la prise de pression en aval de la soupape gaz et y brancher le manomètre
- déconnecter la prise de compensation du caisson d'air

#### 4.5.1 Ciao S C.S.I. : Réglage de la puissance maximum et du minimum eau chaude sanitaire

- Ouvrir un robinet d'eau chaude au débit maximum
- sur le panneau de commande :
  - placer le sélecteur de fonction sur «  » (été) (Fig. 2a)
  - placer le sélecteur de température de l'eau sanitaire au maximum (Fig. 8a)
- mettre la chaudière sous tension en plaçant l'interrupteur général de l'installation sur « allumé »
- vérifier si la pression lue sur le manomètre est stable, ou bien, à l'aide d'un milliampèremètre placé après le modulateur, s'assurer que celui-ci reçoit le courant disponible maximum (120 mA pour G20 et 165 mA pour gaz liquide);
- retirer le capuchon de protection des vis de réglage en faisant levier soigneusement à l'aide d'un tournevis (Fig. 15)
- agir sur l'écrou de réglage de la puissance maximum à l'aide d'une clé en fourchette CH10 afin d'obtenir la valeur indiquée dans le tableau « caractéristiques techniques »
- débrancher le connecteur Faston du modulateur;
- attendre à ce que la pression lue sur le manomètre se stabilise à la valeur minimale
- à l'aide d'une clé Allen, en faisant attention à ne pas presser le petit arbre intérieur, agir sur la vis rouge de réglage de la température minimum de l'eau sanitaire et régler jusqu'à lire sur le manomètre la valeur indiquée dans le tableau « caractéristiques techniques »
- rebrancher le connecteur Faston du modulateur;
- refermer le robinet d'eau chaude sanitaire;
- remettre le capuchon de protection des vis de réglage soigneusement et attentivement.

#### Ciao S R.S.I. : Réglage de la puissance maximum et minimum

- Régler le sélecteur de fonction sur  hiver (fig. 2b)
- Retirer le manteau et accéder à la carte
- Insérer les cavaliers JP1 et JP2
- Porter le trimmer P2 à la valeur maximum, à l'aide d'un tournevis (dans le horaire)
- mettre la chaudière sous tension en plaçant l'interrupteur général de l'installation sur « on »
- Vérifier si la pression lue sur le manomètre est stable ; ou bien, à l'aide d'un milliampèremètre placé en série sur le modulateur, s'assurer que celui-ci reçoit le courant disponible maximum (120 mA pour G20 et 165 mA pour gaz liquide)
- Utiliser un tournevis pour retirer le bouchon de protection sur les vis de réglage
- Agir sur l'écrou de réglage de la puissance maximum à l'aide d'une clé en fourchette CH10 afin d'obtenir la valeur indiquée dans le tableau « caractéristiques techniques »
- Débrancher le connecteur Faston du modulateur
- Attendre que la pression lue sur le manomètre se stabilise à la valeur minimale
- Utiliser une clé Allen pour régler la vis de réglage rouge à la puissance minimale, en la réglant jusqu'à ce que le manomètre affiche une valeur indiquée dans la tableau « caractéristiques techniques »
- Rebrancher le connecteur Faston du modulateur
- Couper la tension de la chaudière
- Retirer les cavaliers JP1 et JP2
- Remettre le capuchon de protection des vis de réglage soigneusement et attentivement.

#### 4.5.2 Réglage électrique du minimum et maximum du chauffage

 La fonction « réglage électrique » est activée et désactivée exclusivement par le cavalier (JP1) (Fig. 16).

ADJ  apparaît sur l'écran pour indiquer que la procédure de réglage est en cours.

La fonction peut être activée des manières suivantes :

- en alimentant la carte avec la bretelle JP1 insérée et le sélecteur de fonction sur « hiver », indépendamment de la présence éventuelle d'autres demandes de fonctionnement.
- en insérant la bretelle JP1, avec le sélecteur de fonction sur l'état hiver, sans demande de chaleur en cours.

⚠ L'activation de la fonction prévoit l'allumage du brûleur en simulant une demande de chaleur en chauffage.

Pour le réglage, agir comme suit :

- éteindre la chaudière
- retirer le manteau et accéder à la carte
- insérer la bretelle JP1 (Fig. 16) pour activer les poignées du panneau de commande aux fonctions de réglage du minimum et du maximum du chauffage.
- s'assurer que le sélecteur de fonction est sur « hiver » (voir le paragraphe 4.2).
- mettre la chaudière sous tension;

⚠ **Carte électrique sous tension (230 V)**

- tourner la poignée de réglage de la température de l'eau de chauffage B (Fig. 17) jusqu'à atteindre la valeur minimale de chauffage, comme indiqué dans le tableau multigaz
- insérer la bretelle JP2 (Fig. 16);
- tourner la poignée de réglage de la température de l'eau sanitaire C (Fig. 17) jusqu'à atteindre la valeur maximale de chauffage, comme indiqué dans le tableau multigaz
- retirer la bretelle JP2 pour mémoriser la valeur maximale de chauffage;
- **retirer la bretelle JP1 pour mémoriser la valeur minimale de chauffage et pour finir la procédure de réglage;**
- rebrancher la prise de compensation au caisson d'air;

Débrancher le manomètre et resserrer la vis de la prise de pression.

⚠ Pour terminer la fonction de réglage sans mémoriser les valeurs configurées, procéder comme suit :

- placer le sélecteur de fonction sur «  » (OFF);
- couper la tension d'alimentation
- déposer JP1/JP2

⚠ La fonction de réglage se termine automatiquement, sans la mémorisation des valeurs limites (minimum et maximum), 15 minutes après son activation.

⚠ La fonction se termine automatiquement même en cas d'arrêt ou de blocage définitif.

Même dans ce cas, la mémorisation des valeurs N'est PAS prévue lorsque la fonction se termine.

#### Remarque

Pour régler uniquement le maximum du chauffage, il est possible de retirer la bretelle JP2 (pour mémoriser le maximum) et ensuite sortir de la fonction, sans mémoriser le minimum, en plaçant le sélecteur de fonction sur «  » (OFF) ou en coupant la tension sur la chaudière.

⚠ Après chaque intervention sur l'élément de réglage de la vanne gaz, le sceller avec un agent d'étanchéité.

Au terme des réglages :

- ramener la température réglée avec le thermostat d'ambiance sur la valeur souhaitée
- porter le sélecteur de température de l'eau du chauffage dans la position souhaitée
- refermer le tableau de bord
- reposer le manteau.

## 4.6 Transformation du gaz

La transformation d'un gaz d'une famille à un gaz d'une autre famille peut s'effectuer facilement même sur la chaudière installée.

La chaudière est livrée pour fonctionner avec du gaz méthane (G20) conformément aux indications de la plaque technique.

Il est possible de transformer les chaudières d'un type de gaz à l'autre à l'aide des kit correspondants fournis sur demande :

- kit de transformation du gaz méthane;
- kit de transformation du gaz liquide;

Pour effectuer le démontage, procéder de la façon indiquée ci-dessous :

- couper l'alimentation électrique de la chaudière et fermer le robinet du gaz ;
- retirer en ordre : le manteau, le couvercle du caisson d'air et le couvercle de la chambre de combustion (Fig. 19);
- déconnecter le branchement du câble bougie;
- sortir le passe-câble inférieur du logement du caisson d'air;
- retirer les vis de fixation du brûleur et démonter ce dernier avec la bougie fixée et ses câbles;
- avec une clé en tube ou en fourchette, démonter les buses et les rondelles et les remplacer par celles du kit.

⚠ **Il faut absolument utiliser et monter les rondelles contenues dans le kit, même avec les collecteurs dépourvus de rondelles.**

- réintroduire le brûleur dans la chambre de combustion et visser les vis de fixation sur le collecteur du gaz;
- placer la passe-câble avec le câble bougie dans son logement sur le caisson d'air;

- rétablir le branchement du câble bougie
- remonter le couvercle de la chambre de combustion et le couvercle du caisson d'air
- renverser le tableau de bord vers l'avant de la chaudière
- ouvrir le couvercle de la carte
- sur la carte de contrôle (Fig. 16) :
  - pour effectuer la transformation du gaz méthane au gaz liquide, introduire le cavalier en position JP3
  - pour effectuer la transformation du gaz liquide au méthane, retirer le pont de la position JP3
- remonter les composants démontés précédemment
- remettre la chaudière sous tension et ouvrir à nouveau le robinet de gaz (avec la chaudière en fonction, vérifier l'étanchéité des joints du circuit d'alimentation en gaz).

⚠ **La transformation ne doit être faite que par du personnel qualifié.**

⚠ **Une fois la transformation achevée, régler à nouveau la chaudière en suivant les indications du paragraphe spécifique et appliquer la nouvelle plaque d'identification contenue dans le kit.**

## 5 ENTRETIEN

Pour garantir la permanence des caractéristiques de fonctionnalité et efficacité du produit et pour respecter les prescriptions des lois en vigueur, il est nécessaire de soumettre l'appareil à des contrôles systématiques à des intervalles réguliers.

La fréquence des contrôles dépend des conditions particulières d'installation et d'utilisation, mais il est de toute façon convenable de faire effectuer un contrôle tous les ans par du personnel agréé des services après-vente.

En cas d'opérations d'entretien sur des structures placées près des conduits des fumées et/ou sur des dispositifs d'évacuation des fumées et leurs accessoires, éteindre l'appareil. Au terme des interventions, faire vérifier leur efficacité par le personnel qualifié.

**IMPORTANT** : avant d'effectuer toute opération de nettoyage ou d'entretien sur l'appareil, agir sur son interrupteur et sur l'interrupteur de l'installation pour couper l'alimentation électrique et fermer l'alimentation en gaz en agissant sur le robinet situé sur la chaudière.

Ne pas nettoyer l'appareil ni ses parties avec des substances facilement inflammables (ex. essence, alcool, etc.).

Ne pas nettoyer les panneaux, les parties peintes et les parties en plastique avec des diluants pour peintures.

Le nettoyage des panneaux doit être réalisé uniquement avec de l'eau savonneuse.

### 5.1 Vérification des paramètres de combustion

**Ciao S C.S.I. :**

Pour analyser la combustion, effectuer les opérations suivantes :

- ouvrir un robinet d'eau chaude au débit maximum
- placer le sélecteur de fonction sur été «  » et le sélecteur de température de l'eau sanitaire au maximum (Fig. 8a).
- retirer la vis du cache de la prise d'analyse de la combustion (Fig. 18) et insérer les sondes
- mettre la chaudière sous tension;

**Ciao S R.S.I. :**

- éteindre la chaudière
- régler le sélecteur de fonction sur le mode hiver
- retirer le manteau et accéder à la carte
- insérer les cavaliers JP1 et JP2
- utiliser un tournevis pour ouvrir le bouchon sur le panneau de commande
- porter le trimmer P2 à la valeur maximum, à l'aide d'un tournevis (dans le horaire)
- retirer la vis du cache de la prise d'analyse de la combustion (Fig. 18) et insérer les sondes
- mettre la chaudière sous tension

L'appareil fonctionne à la puissance maximum et il est possible de contrôler la combustion.











Une fois l'analyse finie :

- fermer le robinet d'eau chaude
- retirer la sonde de l'analyseur et fermer la prise d'analyse de la combustion en fixant avec soin la vis retirée précédemment.













## UTILISATEUR

### 1A AVERTISSEMENTS GÉNÉRAUX ET SÉCURITÉS

Le manuel d'instruction fait partie intégrante du produit et doit donc être conservé soigneusement et toujours accompagner l'appareil ; en cas de perte ou dommage, demander une autre copie au Service après-vente.

-  L'installation de la chaudière et toute autre intervention d'assistance et d'entretien doivent être effectuées par du personnel qualifié selon les dispositions des normes locales et nationales en vigueur.
-  Pour l'installation, il est conseillé de s'adresser à du personnel spécialisé.
-  La chaudière est exclusivement destinée à l'utilisation prévue par le fabricant. Le fabricant décline toute responsabilité pour les dommages aux personnes, aux animaux ou aux biens dus à des erreurs lors de l'installation, du réglage ou de l'entretien et à des usages impropres.
-  Pendant toute la durée de vie de l'installation, les dispositifs de sécurité et de réglage automatique des appareils ne doivent pas être modifiés, si ce n'est pas le constructeur ou le fournisseur.
-  Cet appareil sert à produire de l'eau chaude et doit être branché sur une installation de chauffage et/ou un réseau de distribution d'eau chaude sanitaire, compatible à ses performances et à sa puissance.
-  En cas de fuites d'eau, il faut couper l'alimentation en eau et avertir immédiatement le personnel qualifié du Service après-vente.
-  En cas d'absence prolongée, fermer l'alimentation en gaz et éteindre l'interrupteur général d'alimentation électrique. En cas de prévoir un risque de gel, vidanger l'eau contenue dans la chaudière.
-  Vérifier de temps en temps si la pression d'exercice de l'installation hydraulique ne descend pas au-dessous de 1 bar.
-  En cas de panne et/ou de mauvais fonctionnement de l'appareil, l'arrêter et ne tenter aucune réparation ou intervention directe.
-  L'entretien de l'appareil doit être effectué au moins tous les ans : en le programmant le plus tôt possible avec le Service après-vente on pourra épargner du temps et de l'argent.

L'utilisation de la chaudière exige le strict respect de certaines règles de sécurité fondamentales :

-  Ne pas utiliser l'appareil pour des buts autres que celui auquel il est destiné.
-  Il est dangereux de toucher l'appareil en ayant des parties du corps mouillées ou humides et/ou les pieds nus.
-  Il est tout à fait déconseillé de boucher avec des chiffons, du papier ou d'autres matériaux les grilles d'aspiration et de dissipation et l'ouverture d'aération de la pièce où l'appareil est installé.
-  Ne jamais actionner les interrupteurs électriques, le téléphone ou tout autre objet susceptible de produire des étincelles en cas d'odeur de gaz. Aérer la pièce en ouvrant complètement les portes et les fenêtres et fermer le robinet centrale du gaz.
-  Ne poser aucun objet sur la chaudière.
-  Il est déconseillé d'effectuer une quelconque opération de nettoyage avant d'avoir débranché l'appareil de l'alimentation électrique.
-  Ne pas boucher ou réduire les dimensions des ouvertures d'aération de la pièce où le générateur est installé.
-  Ne pas laisser des récipients ni de substances inflammables dans la pièce où l'appareil est installé.
-  En cas de panne et/ou de mauvais fonctionnement de l'appareil, toute tentative de réparation est déconseillée.
-  Il est dangereux de tirer ou de tordre les câbles électriques.
-  Les enfants et les personnes inexpérimentées ne doivent pas utiliser l'appareil.
-  Ne pas intervenir sur des éléments scellés.

Pour une meilleure utilisation, il faut respecter les consignes suivantes :

- un nettoyage extérieur périodique avec de l'eau savonneuse, en plus d'améliorer l'aspect esthétique, préserve les panneaux de la corrosion en prolongeant leur durée de vie
- si la chaudière murale est renfermée dans des meubles suspendus il faut laisser un espace d'au moins 5 cm par partie pour l'aération et pour permettre l'entretien
- l'installation d'un thermostat d'ambiance contribuera à un plus grand confort, à une utilisation plus rationnelle de la chaleur et à une économie d'énergie en outre, la chaudière peut être associée à un horloge programmeur pour gérer des allumages et des extinctions dans l'espace de la journée ou de la semaine.

### 2A ALLUMAGE

Le premier allumage de la chaudière doit être effectué par du personnel du Service après-vente. Ensuite, s'il est nécessaire de remettre en service l'appareil, suivre attentivement les opérations décrites.

Pour allumer la chaudière, il faut effectuer les opérations suivantes :

- mettre la chaudière sous tension
- ouvrir le robinet de gaz présent sur l'installation afin de permettre le flux du combustible
- tourner le sélecteur de fonction (1 - fig. 1a) sur la position souhaitée :

**Ciao S C.S.I. :**

**Mode été :** en tournant le sélecteur sur le symbole été « ☀ » (Fig. 2a) la fonction traditionnelle d'eau chaude sanitaire uniquement s'active. En cas de demande d'eau chaude sanitaire l'écran numérique affiche la température de l'installation d'eau chaude, l'icône servant à indiquer l'alimentation en eau chaude et l'icône flamme

**Mode hiver :** en tournant le sélecteur de fonction dans la zone marqué + et - (Fig. 2b), la chaudière fournit de l'eau chaude et du chauffage. En cas de demande de chaleur, la chaudière s'allume et l'écran numérique affiche la température de l'eau chaude, l'icône indiquant le chauffage et l'icône flamme (fig. 3a). En cas de demande d'eau chaude sanitaire, la chaudière s'allume et l'écran numérique affiche la température de l'eau chaude, l'icône indiquant l'alimentation en eau chaude et l'icône flamme (fig. 4a)

**Préchauffage** (eau chaude plus rapidement) : tourner à nouveau la poignée de réglage de la température de l'eau sanitaire (2 - fig. 1a) sur le symbole ☺ (fig. 5a), pour désactiver la fonction préchauffage. Cette fonction permet de maintenir chaude l'eau contenue dans l'échangeur sanitaire afin de réduire les temps d'attente durant les prélèvements. Lorsque la fonction préchauffage est activée, l'afficheur indique la température de refoulement de l'eau de chauffage ou de l'eau sanitaire sur la base de la demande en cours. Lors de l'allumage du brûleur, suite à une demande de préchauffage, l'afficheur montre le symbole P (fig. 5b). Pour désactiver la fonction préchauffage, tourner à nouveau la poignée de réglage de la température de l'eau sanitaire sur le symbole ☺. Mettre alors la poignée de réglage de la température de l'eau sanitaire dans la position souhaitée. La fonction est désactivée lorsque la chaudière est en état OFF : sélecteur de fonction (1 - Fig. 1a) sur « ⏻ » éteint (OFF).

**Ciao S R.S.I. :**

**Mode été (uniquement avec le chauffe-eau extérieur branché) :** en tournant le sélecteur sur le symbole de mode été ☀ (fig. 2a) on active la fonction traditionnelle eau chaude sanitaire uniquement, la chaudière produit de l'eau à la température réglée sur le chauffe-eau extérieur. En cas de demande d'eau chaude sanitaire l'écran numérique affiche la température de l'installation d'eau chaude, l'icône servant à indiquer l'alimentation en eau chaude et l'icône flamme

**Mode hiver :** en tournant le sélecteur de fonction dans la zone marqué + et - (Fig. 2b), la chaudière fournit de l'eau chaude pour le chauffage et - si branchée au chauffe-eau extérieur- de l'eau chaude sanitaire. En cas de demande de chaleur, la chaudière s'allume et l'écran numérique affiche la température de l'eau chaude, l'icône indiquant le chauffage et l'icône flamme (fig. 3a). En cas de demande d'eau chaude sanitaire, la chaudière s'allume et l'écran numérique affiche la température de l'eau chaude, l'icône indiquant l'alimentation en eau chaude et l'icône flamme (fig. 4a).

Régler le thermostat d'ambiance à la température souhaitée (~20 °C)

**Ciao S C.S.I. : Réglage de la température de l'eau chaude sanitaire**

Pour régler la température de l'eau sanitaire (salles de bain, douches, cuisine, etc.), tourner la poignée avec le symbole « ☀ » (Fig. 2b) dans la zone marquée + et -.

La chaudière reste en état stand-by, suite à une demande de chaleur, le brûleur s'allume et l'écran numérique affiche la température de l'eau chaude, l'icône indiquant l'alimentation en eau chaude et l'icône flamme. La chaudière restera en fonctionnement jusqu'à ce que les températures réglées soient atteintes, après quoi elle se remettra en stand-by.

Si la DEL lumineuse rouge s'allume sur le symbole « ⚠ » du panneau de commande, cela signifie que la chaudière est en état d'arrêt temporaire (voir le chapitre concernant les signaux lumineux et les anomalies). L'afficheur numérique montre le code d'anomalie détectée (Fig. 6a).

**Ciao S R.S.I. : Réglage de la température de l'eau chaude sanitaire**

**CAS A** chauffage uniquement - le réglage n'est pas nécessaire  
**CAS B** chauffage uniquement + chauffe-eau extérieur avec thermostat - le réglage n'est pas nécessaire.

**CAS C** chauffage uniquement + chauffe-eau extérieur avec sonde - pour régler la température de l'eau sanitaire stockée dans le chauffe-eau, tourner le sélecteur de température avec le symbole dans le sens des aiguilles d'une montre pour augmenter la température et dans le sens inverse pour l'abaisser.

La chaudière reste en état stand-by, suite à une demande de chaleur, le brûleur s'allume et l'écran numérique affiche la température de l'eau chaude, l'icône indiquant l'alimentation en eau chaude et l'icône flamme. La chaudière restera en fonctionnement jusqu'à ce que les températures réglées soient atteintes, après quoi elle se remettra en stand-by.

Si la DEL lumineuse rouge s'allume sur le symbole «  » du panneau de commande, cela signifie que la chaudière est en état d'arrêt temporaire (voir le chapitre concernant les signaux lumineux et les anomalies). L'afficheur numérique montre le code d'anomalie détectée (Fig. 6a)

### Ciao S C.S.I. - Ciao S R.S.I. : Fonction Système automatique de réglage de l'ambiance (S.A.R.A.) (Fig. 7a)

En plaçant le sélecteur de température de l'eau de chauffage dans la zone indiquée par l'inscription « AUTO » - valeur de température de 55 à 65 °C -, le système de réglage automatique S.A.R.A. s'active : la chaudière varie la température de refoulement en fonction du signal de fermeture du thermostat d'ambiance. Une fois atteinte la température réglée avec le sélecteur de température d'eau du chauffage, un comptage de 20 minutes commence. Si pendant cette période le thermostat d'ambiance continue à demander de la chaleur la valeur de la température réglée augmente de 5 °C automatiquement.

Une fois atteinte la nouvelle valeur réglée, un comptage de 20 minutes de plus commence.

Si pendant cette période le thermostat d'ambiance continue à demander de la chaleur la valeur de la température réglée augmente de 5 °C de plus automatiquement.

Cette nouvelle valeur de température est le résultat de la température réglée manuellement avec le sélecteur de température d'eau du chauffage et l'augmentation de +10 °C de la fonction S.A.R.A.

Suite au deuxième cycle, la température est à maintenir à la valeur +10°C prédéfinie jusqu'à ce que la demande du thermostat d'ambiance soit satisfaite.

## 3A EXTINCTION

### Extinction provisoire

En cas de courtes absences, positionner le sélecteur de fonction (1 - Fig. 1a) sur «  » (OFF).

De cette façon (en laissant l'alimentation électrique et l'alimentation en combustible activées), la chaudière est protégée par les systèmes suivants :

- **Fonction antigel** : quand la température d'eau de la chaudière descend en dessous de 5 °C, le circulateur et, au besoin, le brûleur sont activés à la puissance minimale pour reporter la température de l'eau à des valeurs de sécurité (35 °C). Au cours du cycle antigel, le symbole  apparaît sur l'afficheur numérique.
- **Fonction antiblocage du circulateur** : un cycle de fonctionnement est activé toutes les 24 heures.
- **Antigel d'eau chaude sanitaire (uniquement en cas de branchement à un chauffe-eau extérieur avec sonde)** : la fonction est activée si la température mesurée par la sonde du chauffe-eau descend en dessous de 5° C. Une demande de chauffage est générée lors de cette phase avec l'allumage du brûleur à la puissance minimale, laquelle est maintenue jusqu'à ce que la température de l'eau atteigne 55° C. Au cours du cycle antigel, le symbole  apparaît sur l'afficheur numérique.

### Extinction pendant de longues périodes

En cas de longues absences, positionner le sélecteur de fonction (1 - Fig. 1a) sur «  » (OFF).

Fermer ensuite le robinet de gaz présent sur l'installation. Dans ce cas, la fonction antigel est désactivée : vidanger les installations en cas de risque de gel.

## 4A CONTRÔLES

Au début de la saison de chauffage et périodiquement pendant l'utilisation, vérifier si l'hydromètre/thermo-hydromètre indique des valeurs de pression lorsque l'installation est froide étant comprises entre 0,6 et 1,5 bar : cela évite les bruits causés par la présence d'air. Si la circulation d'eau est insuffisante la chaudière s'éteint. La pression de l'eau ne doit jamais descendre au-dessous de 0,5 bar (champ rouge).

Si cela se produit il est nécessaire de rétablir la pression de l'eau chaude dans la chaudière en procédant de la façon suivante :

- placer le sélecteur de fonction (2 - Fig. 1a) sur «  » (OFF)
- tourner le robinet de remplissage (L fig. 13 pour C.S.I. - extérieur pour R.S.I.) jusqu'à ce que la pression indiquée soit comprise entre 1 et 1,5 bar.





















Refermer soigneusement le robinet.

Remettre en place le sélecteur de fonction sur la position de départ.

Si la chute de pression est très fréquente, demander l'intervention du Service après-vente.



## 5A SIGNAUX LUMINEUX ET ANOMALIES

L'état de fonctionnement de la chaudière est indiqué par l'afficheur numérique, les types d'affichage sont reportés plus bas.

ÉTAT DE LA CHAUDIÈRE	AFFICHEUR
Stand-by	-
État OFF	OFF
Alarme de verrouillage du module ACF	A01  
Alarme de panne électrique ACF	A01  
Alarme de thermostat limite	A02 
Alarme de pressostat air	A03 
H2O Alarme de pressostat	A04  
NTC anomalie eau sanitaire (C.S.I. et R.S.I. uniquement avec réchauffeur d'accumulation extérieur à sonde)	A06 
NTC Anomalie de chauffage	A07 
Flamme parasite	A11 
Chauffage min et max réglage électrique	ADJ 
Transitoire en attente d'allumage	88°C clignotant
Intervention du pressostat air	 clignotant
H2O intervention du pressostat	  clignotant
Fonction de préchauffage active (uniquement C.S.I.)	P
Demande de préchauffage (uniquement C.S.I.)	P clignotant
Sonde extérieure présente	
Demande de chauffage eau sanitaire	60°C 
Demande de chauffage	80°C 
Demande de chaleur antigel	
Flamme présente	

### Pour rétablir le fonctionnement (désactiver les alarmes):



#### Anomalies A 01-02-03

Placer le sélecteur de fonction sur «  » éteint (OFF), attendre 5-6 secondes puis le mettre dans la position souhaitée  (été) ou  (hiver). Si les tentatives de déblocage ne réactivent pas la chaudière, demander l'intervention du Service après-vente.

#### Anomalie A 04

En plus du code d'anomalie, l'afficheur numérique visualise le symbole . Vérifier la valeur de la pression indiquée par l'indicateur du niveau d'eau:

Si elle est inférieure à 0,3 bar, placer le sélecteur de fonction sur «  » (OFF) et régler le bouchon de remplissage (L fig. 13 pour C.S.I. - extérieur pour R.S.I.) jusqu'à ce que la pression atteigne une valeur comprise entre 1 et 1,5 bar.

Placer ensuite le sélecteur de mode sur la position souhaitée  (été) ou  (hiver).

La chaudière effectuera un cycle de purge d'environ 2 minutes.

Si les chutes de pression sont fréquentes, demander l'intervention du service Technique Après-vente.

#### Anomalie A 06 (uniquement C.S.I.)

La chaudière fonctionne normalement, mais ne garantit pas la stabilité de la température de l'eau sanitaire, qui reste réglée autour d'une température de 50 °C. S'adresser au Service d'assistance technique.

#### Anomalie A 07

Demander l'intervention du Service après-vente.

## DONNÉES TECHNIQUES

DESCRIPTION			CIAO 20 S C.S.I.	CIAO 24 S C.S.I.	CIAO 24 S R.S.I.
<b>Chauffage</b>	Apport thermique	kW	22,20	25,80	25,80
		kcal/h	19.092	22.188	22.188
	Puissance thermique maximum (80/60°)	kW	20,60	23,94	23,94
		kcal/h	17.717	20.590	20.590
	Apport thermique minimum	kW	7,00	8,90	8,90
		kcal/h	6.020	7.654	7.654
Puissance thermique minimum (80°/60°)	kW	5,88	7,61	7,61	
	kcal/h	5.057	6.544	6.544	
<b>ECS</b>	Apport thermique	kW	22,20	25,80	-
		kcal/h	19.092	22.188	-
	Puissance thermique maximum	kW	20,60	23,94	-
		kcal/h	17.717	20.590	-
	Apport thermique minimum	kW	7,00	8,90	-
		kcal/h	6.020	7.654	-
Puissance thermique minimum	kW	5,88	7,61	-	
	kcal/h	5.057	6.544	-	
Rendement utile (Pn max - Pn min)		%	92,8 - 84,0	92,8 - 85,5	92,8 - 85,5
Rendement 30 % (retour 47°)		%	91,9	90,9	90,9
Performances de combustion		%	93,2	93,0	93,0
Puissance électrique		W	100	116	116
Catégorie			II2H3+	II2H3+	II2H3+
Pays de destination			-	-	-
Tension d'alimentation		V - Hz	230-50	230-50	230-50
Degré de protection		IP	X5D	X5D	X5D
Chute de pression sur la cheminée avec brûleur allumé		%	6,85	6,96	6,96
Chute de pression sur la cheminée avec brûleur éteint		%	0,09	0,07	0,07
<b>Fonctionnement du chauffage</b>					
Pression - température maximale		bar-°C	3 - 90	3 - 90	3 - 90
Pression minimum pour fonctionnement standard		bar	0,25 - 0,45	0,25 - 0,45	0,25 - 0,45
Plage de sélection de la température d'eau de chauffage		°C	40/80	40/80	40/80
Pompe : prévalence maximum disponible pour l'installation avec un débit de		mbar	300	300	300
Vase d'expansion à membrane		l	1.000	1.000	1.000
Pré-charge du vase d'expansion		bar	7	8	8
			1	1	1
<b>Fonctionnement ECS</b>					
Pression maximale		bar	6	6	-
Pression minimale		bar	0,15	0,15	-
Quantité d'eau chaude avec Δt 25 °C		l/min	11,8	13,7	-
avec Δt 30 °C		l/min	9,8	11,4	-
avec Δt 35 °C		l/min	8,4	9,8	-
Puissance minimum ECS		l/min	2	2	-
Plage de sélection de la température ECS		°C	37/60	37/60	-
Régulateur de débit		l/min	8	10	-
<b>Pression du gaz</b>					
Pression nominale gaz méthane (G20)		mbar	20	20	20
Pression nominale gaz méthane (G30/G31)		mbar	28-30/37	28-30/37	28-30/37
<b>Raccordements hydrauliques</b>					
Apport - débit calorifique		Ø	3/4"	3/4"	3/4"
Entrée - sortie sanitaire		Ø	1/2"	1/2"	-
Refoulement - débit du réservoir d'eau		Ø	-	-	3/4"
Entrée gaz		Ø	3/4"	3/4"	3/4"
<b>Dimensions de la chaudière</b>					
Hauteur		mm	715	715	715
Largeur		mm	405	405	405
Profondeur du logement		mm	248	248	248
Poids chaudière		kg	29	31	28
<b>Débits (G20)</b>					
Débit d'air		Nm³/h	36,875	39,613	39,613
Débit des fumées		Nm³/h	39,101	42,204	42,204
Débit en masse des fumées (max.-min.)		gr/s	13,310 - 14,540	14,308-16,247	14,308-16,247
<b>Débits (G30)</b>					
Débit d'air		Nm³/h	35,328	40,249	40,249
Débit des fumées		Nm³/h	36,955	41,008	41,008
Débit en masse des fumées (max.-min.)		gr/s	13,100 - 14,030	13,985 - 16,429	13,985 - 16,429

DESCRIPTION		CIAO 20 S C.S.I.	CIAO 24 S C.S.I.	CIAO 24 S R.S.I.
<b>Débits (G31)</b>				
Débit d'air	Nm³/h	36,405	40,454	40,454
Débit des fumées	Nm³/h	38,119	41,455	41,455
Débit en masse des fumées (max.-min.)	gr/s	13,480 - 14,280	14,120 - 16,683	14,120 - 16,683
<b>Performance du ventilateur</b>				
Hauteur de charge résiduelle de la chaudière sans les tuyaux	Pa	43	110	110
<b>Conduits d'évacuation concentriques des fumées</b>				
Diamètre	mm	60-100	60 - 100	60 - 100
Longueur maximum	m	4,25	4,25	4,25
Chute due à l'insertion d'une courbe à 45°/90°	m	1 - 1,5	1 - 1,5	1 - 1,5
Diamètre du trou de traversée du mur	mm	105	105	105
<b>Conduits d'évacuation concentriques des fumées</b>				
Diamètre	mm	80-125	80-125	80-125
Longueur maximum	m	12,40	12,4	12,4
Perte causée par l'introduction d'un coude 45°/90°	m	1,35 - 2,2	1,35 - 2,2	1,35 - 2,2
Diamètre du trou de traversée du mur	mm	130	130	130
<b>Conduits d'évacuation séparés des fumées</b>				
Diamètre	mm	80	80	80
Longueur maximum	m	10 + 10	16 + 16	16 + 16
Perte causée par l'introduction d'un coude 45°/90°	m	1,2 - 1,7	1,2 - 1,7	1,2 - 1,7
<b>Installation B22P-B52P</b>				
Diamètre	mm	80	80	80
Longueur maximale du tuyau d'évacuation	m	14	25	25
Classe NOx		3	3	3
<b>Valeurs d'émission avec le débit maximum et minimum du gaz G20*</b>				
Maximum - Minimum CO s.a. inférieur à	ppm	100 - 180	120 - 200	120 - 200
CO <sub>2</sub>	%	7,1 - 2,0	7,3 - 2,2	7,3 - 2,2
Maximum - Minimum NOx s.a. inférieur à	ppm	180 - 100	200 - 100	200 - 100
Température des fumées	°C	127 - 97	142 - 109	142 - 109

\* Contrôle effectué sur tuyau concentrique ø 60-100, longueur 0,85m - température de l'eau 80-60°C









### Tableau multigaz

DESCRIPTION		Gaz méthane (G20)			Butane (G30)			Propane (G31)		
		20 S C.S.I.	24 S C.S.I.	24 S R.S.I.	20 S C.S.I.	24 S C.S.I.	24 S R.S.I.	20 S C.S.I.	24 S C.S.I.	24 S R.S.I.
Indice de Wobbe inférieur (à 15 °C-1013 mbar)	MJ/m³S	45,67			80,58			70,69		
Pouvoir calorifique inférieur	MJ/m³S	34,02			116,09			88		
Pression nominale d'alimentation	mbar (mm W.C.)	20 (203,9)			28 - 30 (285,5 - 305,9)			37 (377,3)		
Pression minimum d'alimentation	mbar (mm W.C.)	13,5 (137,7)			-			-		
Brûleur (nombre des trous)	n°	11			11			11		
Brûleur (diamètre des trous)	mm	1,30	1,35	1,35	0,75	0,78	0,78	0,75	0,78	0,78
Capacité maximale de gaz de chauffage	Sm³/h	2,35	2,73	2,73						
	kg/h				1,75	2,03	2,03	1,72	2,00	2,00
Capacité maximale de gaz ECS	Sm³/h	2,35	2,73	-						
	kg/h				1,75	2,03	-	1,72	2,00	-
Capacité minimale de gaz de chauffage	Sm³/h	0,74	0,94	0,94						
	kg/h				0,55	0,70	0,70	0,54	0,69	0,69
Capacité minimale de gaz ECS	Sm³/h	0,74	0,94	-						
	kg/h				0,55	0,70	-	0,54	0,69	-
Pression max en aval du robinet en chauffage	mbar	10,40	11,80	11,80	28,00	27,80	27,80	36,00	35,80	35,80
	mm W.C.	106,05	120,33	120,33	285,52	283,48	283,48	367,10	365,06	365,06
Pression max en aval du robinet en sanitaire	mbar	10,40	11,80	-	28,00	27,80	-	36,00	35,80	-
	mm W.C.	106,05	120,33	-	285,52	283,48	-	367,10	365,06	-
Pression min en aval du robinet en chauffage	mbar	1,20	1,50	1,50	3,00	3,30	3,30	3,90	4,30	4,30
	mm W.C.	12,24	15,30	15,30	30,59	33,65	33,65	39,77	43,85	43,85
Pression min en aval du robinet en sanitaire	mbar	1,20	1,50	-	3,00	3,30	-	3,90	4,30	-
	mm W.C.	12,24	15,30	-	30,59	33,65	-	39,77	43,85	-



## ES INSTALADOR



### 1 - ADVERTENCIAS Y DISPOSITIVOS DE SEGURIDAD

-  Las calderas producidas en nuestros establecimientos se fabrican prestando atención a cada uno de los componentes de manera tal de proteger tanto al usuario como al instalador contra eventuales accidentes. Se aconseja al personal cualificado, después de cada intervención efectuada en el producto, que preste particular atención a las conexiones eléctricas, sobre todo por lo que se refiere a la parte no cubierta de los conductores, que de ninguna forma tiene que sobresalir de la bornera, evitando de esta forma el posible contacto con las partes vivas de dicho conductor.
-  El presente manual de instrucciones, junto con el del usuario, forma parte integrante del producto: hay que comprobar que forme parte del equipamiento del aparato, incluso en el caso de cesión a otro propietario o usuario, o bien de traslado a otra planta. En el caso de que se dañe o se pierda, hay que solicitar otro ejemplar al Centro de Asistencia Técnica de la zona.
-  La instalación de la caldera y cualquier otra intervención de asistencia y de mantenimiento, deben ser realizadas por personal cualificado según las normas locales y nacionales vigentes.
-  Se aconseja al instalador que instruya al usuario sobre el funcionamiento del aparato y sobre las normas fundamentales de seguridad.
-  Esta caldera solo se debe utilizar para la aplicación para la cual fue diseñada. Se excluye cualquier responsabilidad contractual y extracontractual del fabricante por daños causados a personas, animales o cosas, por errores de instalación, regulación, mantenimiento y usos impropios.
-  Después de haber quitado el embalaje, se debe comprobar que el contenido esté íntegro y completo. En el caso de que no exista correspondencia, ponerse en contacto con el revendedor donde se ha adquirido el aparato.
-  El conducto de evacuación de la válvula de seguridad del aparato se debe conectar a un adecuado sistema de recogida y descarga. El fabricante del aparato no es responsable de los eventuales daños causados por la intervención de la válvula de seguridad.
-  Eliminar los elementos de embalaje en los contenedores adecuados en los centros de recogida específicos.
-  Los residuos deben eliminarse sin causar peligro a la salud del hombre y sin utilizar procedimientos o métodos que pudieran producir daños al medio ambiente.



Durante la instalación, se debe informar al usuario que:

- en el caso de pérdidas de agua, se debe cerrar la alimentación hídrica y avisar inmediatamente al Centro de Asistencia Técnica
- la presión de funcionamiento de la instalación hidráulica debe ser de entre 1 y 2 bares, y por lo tanto, no sobrepasar los 3 bares. De ser necesario, restablecer la presión como se indica en el párrafo titulado "Llenado del sistema"
- en el caso de que no se utilice la caldera durante un largo periodo, se aconseja la intervención del Centro de Asistencia Técnica para efectuar al menos las siguientes operaciones:
  - colocar el interruptor principal del aparato y el general de la instalación en "apagado"
  - cerrar los grifos del combustible y del agua, tanto de la instalación térmica como la del agua sanitaria
  - vaciar la instalación térmica y la del agua sanitaria si existiese riesgo de hielo
- realizar el mantenimiento de la caldera al menos una vez al año, programándola con antelación con el Servicio Técnico de Asistencia.







Desde el punto de vista de la seguridad se debe recordar que:

-  No se aconseja que los niños o las personas incapacitadas usen la caldera sin asistencia.
-  Es peligroso accionar dispositivos o aparatos eléctricos, tales como interruptores, electrodomésticos, etc., si se advierte olor

En algunas partes del manual se utilizan estos símbolos:

-  ATENCIÓN = para acciones que requieren especial cuidado y preparación apropiada
-  PROHIBIDO = para acciones que absolutamente NO DEBEN ser realizadas

a combustible o de combustión. En el caso de pérdidas de gas, airear el local, abriendo puertas y ventanas; cerrar el grifo general del gas; solicitar la inmediata intervención de personal profesionalmente cualificado del Centro de Asistencia Técnica

-  No tocar la caldera si se está descalzo o con partes del cuerpo mojadas o húmedas
-  Antes de efectuar las operaciones de limpieza, desconectar la caldera de la red de alimentación eléctrica colocando el interruptor bipolar de la instalación y el principal del panel de mandos en "OFF"
-  Está prohibido modificar los dispositivos de seguridad o de regulación sin la autorización o las indicaciones del fabricante
-  No estirar, dividir o torcer los cables eléctricos que sobresalgan de la caldera, aunque esté desconectada de la red de alimentación eléctrica
-  Evitar tapar o reducir dimensionalmente las aperturas de aireación del local de instalación
-  No dejar contenedores y sustancias inflamables en el local donde esté instalado el aparato
-  No dejar los elementos del embalaje al alcance de los niños.

### 2 - DESCRIPCIÓN De la CALDERA

**Ciao S C.S.I.** es una caldera empotrada tipo C para calefaccionar y producir agua caliente sanitaria: según sea el accesorio para la evacuación de humos de combustión se puede clasificar en las siguientes categorías B22P, B52P, C12, C22, C32, C42, C52, C62, C82, C92, C12x, C32x, C42x, C52x, C62x, C82x, C92x.

**Ciao S R.S.I.** es una caldera empotrada tipo C que funciona con diferentes modos:

#### MODO A

solo calentamiento sin ninguna calefacción externa conectada. La caldera no suministra agua caliente sanitaria.

#### MODO B

solo calentamiento con un calentador externo conectado, gestionado por un termostato: en esta condición, a cada solicitud de calor por parte del termostato calentador, la caldera procede a suministrar agua caliente para la preparación del agua sanitaria.

#### MODO C

solo calentamiento con un calentador externo conectado (kit accesorio bajo pedido), gestionado por una sonda de temperatura, para la preparación del agua caliente sanitaria. Conectando un calentador suministrado por nosotros, asegurarse de que la sonda NTC utilizada tenga las siguientes características: 10 kOhm a 25°C, B 3435 ±1%

En la configuración B22P y B52P (cuando se instala en el interior) el aparato no puede ser instalado en locales destinados a dormitorios, baños, duchas o en donde existan chimeneas abiertas sin flujo de aire propio. El local donde se instalará la caldera deberá tener una ventilación adecuada.

En la configuración C, el aparato puede ser instalado en cualquier tipo de local y no existe ninguna limitación debida a las condiciones de aireación y al volumen del local.

### 3 - NORMAS DE INSTALACIÓN

#### 3.1 - Normas de instalación

La instalación debe ser realizada por personal cualificado.

Además, siempre se deben respetar las disposiciones nacionales y locales.

#### UBICACIÓN

**Ciao S** se puede instalar en interiores (fig. 2).

La caldera está equipada con protecciones que garantizan su correcto funcionamiento con un rango de temperaturas de 0°C a 60°C.

Para poder aprovechar las protecciones, el aparato debe poder encenderse, por lo que se desprende que cualquier situación de bloqueo (por ej., falta de gas o de alimentación eléctrica, o bien una intervención de seguridad) desactiva las protecciones.

**DISTANCIAS MÍNIMAS**

Para poder permitir el acceso al interior de la caldera para realizar las normales operaciones de mantenimiento, se deben respetar los espacios mínimos previstos para la instalación (fig. 3).  
 Para colocar correctamente el aparato, se debe tener en cuenta que:  
 - no se debe colocar sobre una cocina u otro aparato de cocción  
 - está prohibido dejar sustancias inflamables en el local donde esté instalada la caldera  
 - las paredes sensibles al calor (por ejemplo las de madera) deben protegerse con una aislación apropiada.

**IMPORTANTE**

Antes de la instalación, se aconseja lavar cuidadosamente todas las tuberías de la instalación para remover eventuales residuos que podrían comprometer el funcionamiento correcto del aparato.  
 Instalar debajo de la válvula de seguridad un embudo para recoger el agua con su correspondiente descarga, en caso de pérdidas por sobrepresión de la instalación de calefacción. El circuito de agua sanitaria no necesita de una válvula de seguridad, pero debe asegurarse que la presión del acueducto no supere los 6 bar. Si no existe certeza sobre la presión, se deberá instalar un reductor de presión.  
 Antes del encendido, asegurarse de que la caldera esté preparada para funcionar con el gas disponible; esto se comprueba por la leyenda del embalaje y por la etiqueta adhesiva que indica el tipo de gas.  
 Es muy importante destacar que en algunos casos, las chimeneas adquieren presión y por lo tanto las uniones de los diferentes elementos deben ser herméticas.

**SISTEMA ANTI-CONGELAMIENTO**

La caldera está equipada de serie con un sistema antihielo automático, que se activa cuando la temperatura del agua del circuito principal desciende por debajo de los 6 °C. Este sistema está siempre activo y garantiza la protección de la caldera a una temperatura exterior de -3 °C. Para aprovechar esta protección (basada en el funcionamiento del quemador), la caldera debe poder encenderse sola; cualquier situación de bloqueo (por ej. falta de gas o de alimentación eléctrica, o la intervención de un dispositivo de seguridad) desactiva la protección.  
 La protección antihielo está activa incluso si la caldera está en standby. En condiciones de funcionamiento normales, la caldera puede autoprotgerse del hielo. Si la máquina queda sin alimentación por periodos prolongados de tiempo en zonas donde las temperaturas puedan ser inferiores a 0 °C, y cuando no se desee vaciar la instalación de calefacción, se prescribe agregar un líquido anticongelante de marca reconocida en el circuito primario. Seguir las instrucciones del fabricante prestando atención no sólo al porcentaje del líquido anticongelante que se utilizará para las temperaturas mínimas a las que se mantendrá la circulación de la máquina, y también para la duración y eliminación de dicho líquido.  
 Para la parte de agua caliente sanitaria, se recomienda vaciar el circuito. Los materiales con los cuales están realizados los componentes de las calderas resisten los líquidos anticongelantes a base de glicol de etileno.

**3.2 Fijación de la caldera a la pared y conexiones hidráulicas**

Para fijar la caldera a la pared utilizar la plantilla de premontaje de cartón (fig. 4-5) presente en el embalaje. La posición y la dimensión de los acoplamientos hidráulicos se indican en detalle a continuación:

<b>A</b>	retorno calefacción	3/4"
<b>B</b>	ida calefacción	3/4"
<b>C</b>	conexión gas	3/4"
<b>D</b>	salida ACS	1/2" (para C.S.I.) - 3/4" (para R.S.I.)
<b>D</b>	entrada ACS	1/2" (para C.S.I.) - 3/4" (para R.S.I.)





En caso de sustituir una caldera Beretta de un modelo anterior, se encuentra a disposición un kit de adaptación para las conexiones hidráulicas.

**3.3 Conexión eléctrica**

Las calderas salen de la fábrica completamente cableadas con el cable de alimentación eléctrica ya conectado y sólo necesitan la conexión del termostato ambiente (TA), que debe realizarse a los bornes específicos. Para acceder a la bornera:  
 - colocar el interruptor general de la instalación en "apagado"  
 - desenroscar los tornillos (A) de fijación de la cubierta (fig. 6)  
 - desplazar hacia adelante y luego hacia arriba la base de la cubierta para desengancharla del bastidor  
 - desenroscar el tornillo de fijación (B) del panel (fig. 7)  
 - volcar el panel hacia uno mismo  
 - retirar la cubierta de la bornera (fig. 8)  
 - insertar el cable de la eventual T.A. (fig. 9)  
 El termostato ambiente debe conectarse tal como se indica en el esquema eléctrico.

 **Entrada termostato ambiente con baja tensión de seguridad (24 Vdc).**

La conexión a la red eléctrica debe realizarse mediante un dispositivo de separación con apertura omnipolar de por lo menos 3,5 mm (EN 60335-1, categoría III).  
 El aparato funciona con una corriente alterna de 230 Volt/50 Hz y una energía eléctrica de 100W para 20 C.S.I. - 115W para 24 C.S.I. 24 R.S.I. (y cumple con el estándar EN 60335-1).

-  Es obligatoria la conexión con una instalación eficiente de puesta a tierra, según las normas nacionales y locales vigentes.
-  Se aconseja respetar la conexión fase neutro (L-N).
-  El conductor de tierra debe ser un par de centímetros más largos que los demás.
-  **Está prohibido el uso de tubos de gas y/o agua como puesta a tierra de aparatos eléctricos.**

El fabricante no se considerará responsable por los eventuales daños causados por la falta de puesta a tierra de la instalación.  
 Para la conexión eléctrica utilizar **el cable de alimentación suministrado en dotación.**  
**En el caso de sustituir el cable de alimentación, utilizar un cable tipo HAR H05V2V2-F, 3 x 0,75 mm<sup>2</sup>, con diámetro máx. externo de 7 mm.**

**3.4 Conexión del gas**



Antes de realizar la conexión del aparato a la red de gas, controlar que:  
 - hayan sido respetadas las normas nacionales y locales de instalación  
 - el tipo de gas sea aquel para el cual el aparato está preparado  
 - las tuberías estén limpias.  
 Está previsto que la canalización del gas sea externa. En el caso de que el tubo atraviese la pared, tendrá que pasar a través del orificio central de la parte inferior de la plantilla.  
 Se aconseja instalar en la línea del gas un filtro de adecuadas dimensiones, en el caso de que la red de distribución pudiera contener partículas sólidas. Una vez realizada la instalación, compruebe que las uniones efectuadas sean estancas, como prevén las vigentes normas sobre la instalación

**3.5 Evacuación de los productos de la combustión y aspiración del aire**

Para la evacuación de los productos de combustión, consultar las normas locales y nacionales vigentes. Además, siempre se deben respetar las normas locales de los Bomberos, de la Dirección General de Política Energética y Minas y de las eventuales disposiciones del ayuntamiento. La evacuación de los productos de la combustión está asegurada por un ventilador centrífugo ubicado en el interior de la cámara de combustión y su funcionamiento correcto está constantemente controlado por un presostato. La caldera se entrega sin el kit de evacuación de humos/aspiración de aire, ya que pueden utilizarse los accesorios para aparatos de cámara estanca de tiraje forzado que mejor se adecúen a las características de la tipologías de instalación.  
 Es indispensable para la evacuación de los humos y para el restablecimiento del aire comburente de la caldera que se empleen tuberías certificadas y que la conexión se realice de manera correcta, tal como se indica en las instrucciones suministradas en dotación con los accesorios de los humos.  
 A una sola chimenea se pueden conectar varios aparatos con la condición de que todos sean del tipo de cámara estanca.

**INSTALACIÓN "APERTURA FORZADA" (TIPO B22P/B52P)**

**Conducto de salida humos Ø 80 mm (fig. 10a)**  
 El conducto de salida humos se puede orientar en la dirección más adecuada a las exigencias de la instalación. Para la instalación seguir las instrucciones facilitadas con el kit accesorio.

-  En esta configuración la caldera está conectada al conducto de salida humos Ø 80 mm a través de un adaptador Ø 60-80 mm. En este caso el aire comburente se toma del local de instalación de la caldera que tiene que ser un local debidamente ventilado.
-  Los conductos de salida de humos no aislados son potenciales fuentes de peligro.

La brida de humos (F), cuando sea necesaria, debe quitarse haciendo palanca con un destornillador.  
 La caldera adecua automáticamente la ventilación en base al tipo de instalación y a la longitud del conducto.

**20 C.S.I.**

Longitud conductos Ø 80 [m]	Brida humos (F)	Pérdidas de carga de cada curva (m)	
		45°	90°
hasta 1,5	Ø 39	1,2	1,7
de 1,5 a 5	Ø 41 (**)		
de 5 a 14	Ø 43		

(\*\*) montada en la caldera

**24 C.S.I. - 24 R.S.I.**

Longitud conductos Ø 80 [m]	Brida humos (F)	Pérdidas de carga de cada curva (m)	
		45°	90°
hasta 2	Ø 42	1,2	1,7
de 2 a 8	Ø 44 (**)		
de 8 a 25	no instalada		

(\*\*) montada en la caldera

**CONDUCTOS DE EVACUACIÓN COAXIALES ( ø 60-100)**

La caldera se suministra lista para conectarla a conductos de evacuación/aspiración coaxiales y con la apertura para la aspiración del aire (E) cerrada (fig. 10b). Los conductos de evacuación coaxiales se pueden orientar en la dirección más adecuada a las exigencias del local, respetando las longitudes máximas indicadas en la tabla. Para la instalación, seguir las instrucciones suministradas con el kit.

De acuerdo a la longitud utilizada de los conductos, se debe insertar una brida, escogiéndola entre aquellas contenidas en la caldera (ver las tablas expuestas a continuación). La brida de humos (F) debe quitarse cuando sea necesario, haciendo palanca con un destornillador. La tabla indica las longitudes rectilíneas admitidas. De acuerdo a la longitud utilizada de los conductos, se debe insertar una brida, escogiéndola entre aquellas contenidas en la caldera (ver las tablas expuestas a continuación).

**20 C.S.I.**

Longitud conductos [m]	Brida humos (F)	Pérdidas de carga de cada curva (m)	
		45°	90°
hasta 0,85	Ø 39	1	1,5
de 0,85 a 2,35	Ø 41 (**)		
de 2,35 a 4,25	Ø 43		

(\*\*) montada en la caldera

**24 C.S.I. - 24 R.S.I.**

Longitud conductos [m]	Brida humos (F)	Pérdidas de carga de cada curva (m)	
		45°	90°
hasta 0,85	Ø 42	1	1,5
de 0,85 a 2,35	Ø 44 (**)		
de 2,35 a 4,25	no instalada		

(\*\*) montada en la caldera

**Conductos coaxiales (ø 80/125)**

La caldera se suministra predispuesta para conectarla a conductos de evacuación/aspiración coaxiales y con la apertura para la aspiración del aire cerrada. Los conductos coaxiales de evacuación se pueden orientar en la dirección más adecuada a las exigencias del local, respetando las longitudes máximas indicadas en la tabla.

Para la instalación, seguir las instrucciones suministradas con el kit. Para atravesar la pared hay que realizar un agujero de Ø 140 mm. Dependiendo de la longitud utilizada de los conductos, se debe instalar una brida escogiéndola entre las contenidas en la caldera (ver la tabla). Prestar especial atención a la temperatura exterior y a la longitud del conducto. Tomar como referencia los gráficos para establecer la obligatoriedad o no del empleo del recogedor de condensación. En el caso de funcionamiento con temperaturas de la caldera inferiores a 60 °C, es obligatorio el empleo del recogedor de la condensación. En el caso de utilizar el recogedor de la condensación hay que prever una inclinación del conducto de evacuación de los humos de 1% hacia dicho recogedor. Conectar el sifón del recogedor de la condensación a una evacuación de las aguas blancas.

Los conductos de evacuación no aislados son potenciales fuentes de peligro.

**20 C.S.I.**

Longitud conductos Ø 80 125 [m]	Brida humos (F)	Pérdidas de carga de cada curva (m)	
		45°	90°
de 0,96 a 3,85	Ø 39	1,35	2,2
de 3,85 a 7,85	Ø 41 (**)		
de 7,85 a 12,40	Ø 43		

(\*\*) montada en la caldera

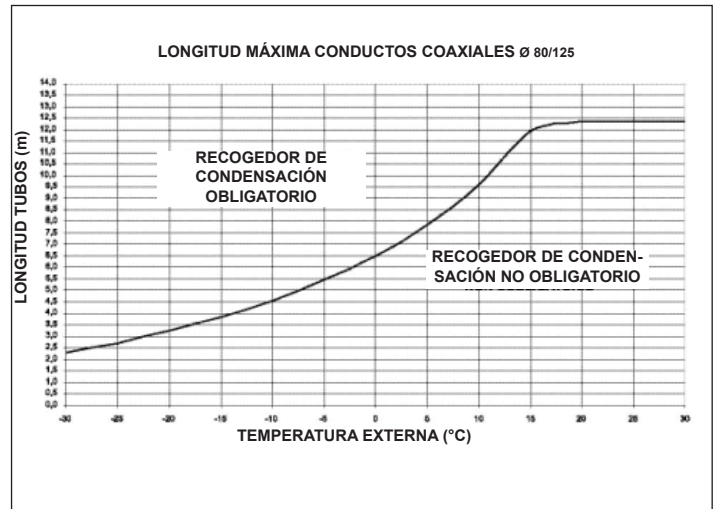

**kit curva coaxial rebajada**

⚠ Si fuera necesario instalar Ciao S en instalaciones ya existentes (sustitución de los modelos Ciao N/Mynute), se encuentra disponible el "kit curva coaxial rebajada" que permite colocar la caldera conservando el mismo orificio de salida de humos.

Longitud conductos con curva rebajada [m]	Brida humos (F)		Pérdidas de carga de cada curva (m)	
	Ciao S 20 C.S.I.	Ciao S 24 C.S.I.	45°	90°
hasta 1,85	Ø 41	Ø 44	1	1,5
de 1,85 a 4,25	Ø 43	ninguna brida		

**24 C.S.I. - 24 R.S.I.**

Longitud conductos Ø 80 125 [m]	Brida humos (F)	Pérdidas de carga de cada curva (m)	
		45°	90°
de 0,96 a 3,85	Ø 42	1,35	2,2
de 3,85 a 7,85	Ø 44 (**)		
de 7,85 a 12,4	no instalada		

(\*\*) montada en la caldera

**CONDUCTOS DE EVACUACIÓN DESDOBLADOS (ø 80) (fig. 11)**

Los conductos de evacuación desdoblados se pueden orientar en la dirección más adecuada dependiendo de las exigencias del local. Para utilizar el tubo de aspiración del aire comburente, se debe seleccionar una de las dos entradas (G y H). Retirar el conector de cierre fijado con tornillos y utilizar el adaptador específico relacionado con la entrada elegida.

⚠ El adaptador de la entrada de aire de diámetro 80 (X) debe orientarse correctamente, por lo tanto es necesario fijarlo con los tornillos apropiados, para que la pestaña no interfiera con la tapa: X adaptador de entrada de aire diámetro 80 - Y adaptador de entrada de aire de diámetro 60 a 80.

La brida de humos (F) debe quitarse cuando sea necesario, haciendo palanca con un destornillador. La tabla indica las longitudes rectilíneas admitidas. De acuerdo a la longitud utilizada de los conductos, se debe insertar una brida, escogiéndola entre aquellas contenidas en la caldera (ver las tablas expuestas a continuación).

**20 C.S.I.**

Longitud conductos [m]	Brida humos (F)	Pérdidas de carga de cada curva (m)	
		45°	90°
1+1	Ø 39	1.2	1.7
>1+1 ÷ 4+4	Ø 41 (**)		
>4+4 ÷ 10+10	Ø 43		

(\*\*) montada en la caldera

**24 C.S.I. - 24 R.S.I.**

Longitud conductos [m]	Brida humos (F)	Pérdidas de carga de cada curva (m)	
		45°	90°
2+2	Ø 42	1,2	1,7
> 2+2 ÷ 6+6	Ø 44 (**)		
> 6+6 ÷ 16+16	no instalada		

(\*\*) montada en la caldera

**3.6 Llenado de la instalación de calefacción (fig. 13)**

Una vez efectuadas las conexiones hidráulicas, se puede seguir con el llenado de la instalación de calefacción. Esta operación se tiene que realizar con la instalación en frío, efectuando las siguientes operaciones:

- dar dos o tres vueltas al tapón de la válvula automática de purgado de aire (I)
- asegurarse de que el grifo de entrada de agua fría esté abierto
- abrir el grifo de llenado (L fig. 13 para C.S.I. - externo para R.S.I.) hasta que la presión indicada por el manómetro de agua se encuentre entre 1 y 1,5 bares.

Cuando se complete el llenado, cerrar el grifo de llenado.

La caldera está equipada con un eficiente separador de aire para el cual no se requiere ninguna operación manual. El quemador se enciende sólo si la fase de purgado del aire se ha terminado.

**3.7 Vaciado de la instalación de calefacción**

Para vaciar la instalación siga las siguientes instrucciones:

- apagar la caldera
- aflojar la válvula de vaciado de la caldera (M)
- vaciar los puntos más bajos de la instalación.

**3.8 Vaciado del agua caliente sanitaria (sólo para modelos C.S.I.)**

Cada vez que exista el riesgo de hielo, el circuito sanitario se debe vaciar de la siguiente forma:

- cerrar el grifo general de la red hídrica
- abrir todos los grifos del agua caliente y fría
- vaciar los puntos más bajos.

**ADVERTENCIA**

Cuando se descarga la válvula de seguridad (N) se debe conectar a un adecuado sistema de recogida. El fabricante no puede ser considerado responsable de eventuales inundaciones causadas por la intervención de la válvula de seguridad.

**B22P/B52P Aspiración en interiores y descarga en exterior**

**C12-C12x** Evacuación concéntrica en pared. Los tubos pueden separarse independientemente de la caldera, pero las salidas deben ser concéntricas o encontrarse lo suficientemente cercanas para ser sometidas a condiciones de viento similares (dentro de 50 cm)

**C22** Descarga mediante la evacuación concéntrica en chimenea común (aspiración y evacuación en la misma chimenea)

**C32-C32x** Evacuación concéntrica en techo. Salidas para C13

**C42-C42x** Evacuación y aspiración en chimeneas comunes separadas, pero sometidas a condiciones de viento similares

**C52-C52x** Líneas de evacuación y aspiración separadas, en la pared o en el techo y en zonas con presiones diferentes. Las líneas de evacuación y succión nunca deben ubicarse en paredes opuestas

**C62-C62x** Las líneas de evacuación y aspiración utilizan tubos comercializados y certificados por separado (1856/1)

**C82-C82x** Evacuación mediante una chimenea individual o común y un tubo de aspiración conectado a la pared

**C92-C92x** Evacuación en techo (similar a C33) y aspiración de aire de una chimenea individual existente

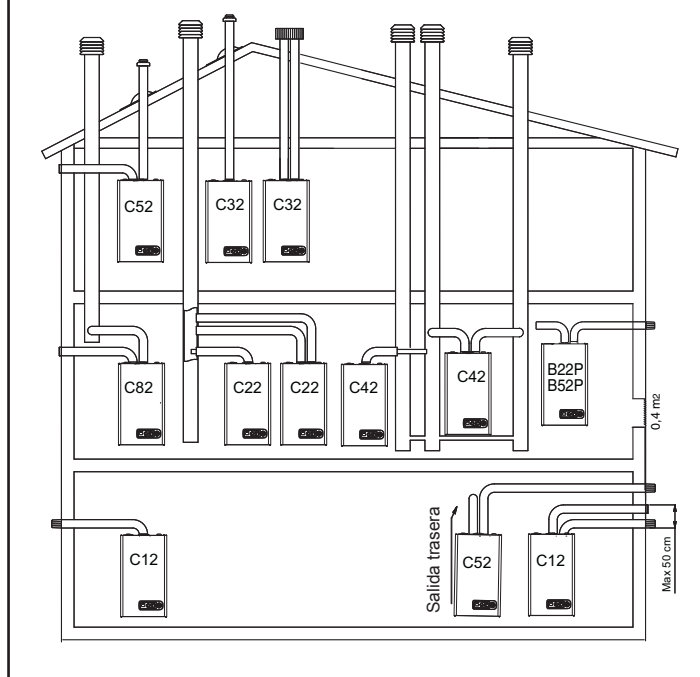

## 4 ENCENDIDO Y FUNCIONAMIENTO

### 4.1 Controles preliminares

El primer encendido debe ser realizado por personal competente de un Centro de Asistencia Técnica autorizado Beretta.

Antes de poner en marcha la caldera, se debe controlar:

- que los datos de las redes de alimentación (eléctrica, hídrica, gas) correspondan con los de la matrícula
- que las tuberías que salen de la caldera estén recubiertas por una funda termoaislante
- que los conductos de evacuación de los humos y aspiración del aire sean eficientes
- que se garanticen las condiciones para las normales operaciones de mantenimiento en el caso de que la caldera se monte dentro o entre muebles
- la estanqueidad de la instalación de suministro del combustible
- que la potencia del combustible corresponda con los valores requeridos por la caldera
- que la instalación de alimentación del combustible sea proporcional al caudal que necesita la caldera y que esté equipado con todos los dispositivos de seguridad y control prescritos por las normas vigentes.

### 4.2 Encendido del aparato

Para el encendido de la caldera se deben realizar las siguientes operaciones:

- conectar la alimentación eléctrica de la caldera
- abrir el grifo de gas presente en la instalación para permitir el flujo de combustible
- colocar el selector de modo (1 - fig. 1a) en la posición deseada:

#### Ciao S C.S.I.:

**Modo verano:** girando el selector en el símbolo verano "☀" (fig. 2a) sólo se activa la función tradicional de agua caliente sanitaria. En caso de que haya una petición de agua caliente sanitaria la pantalla digital exhibirá la temperatura del sistema de agua caliente, el icono para indicar el suministro de agua caliente y el icono de la llama

**Modo invierno:** girando el selector de modo dentro de la zona marcada + y - (fig. 2b), la caldera suministra agua caliente sanitaria y de calefacción. Si se solicita calefacción, la caldera se enciende y el monitor digital señala la temperatura de calentamiento del agua, el icono para indicar la calefacción y el icono de llama (fig. 3a). En caso de que haya una petición de agua caliente sanitaria, la caldera se enciende y la pantalla digital exhibirá la temperatura del sistema de agua caliente, el icono para indicar el suministro de agua caliente y el icono de la llama (fig. 4a)

**Precaentamiento** (agua caliente más rápido): girar el pomo de regulación de temperatura del agua caliente sanitaria (2 - fig. 1a) al ☺ símbolo (fig. 5a), para activar la función de pre-caentamiento. Esta función permite mantener caliente el agua presente en intercambiador sanitario para reducir los tiempos de espera durante los suministros. Cuando se habilita la función de pre-caentamiento, la pantalla indica la temperatura de alimentación del agua de calentamiento o del agua sanitaria según la solicitud en curso. Durante el encendido del quemador, después de una solicitud de pre-caentamiento, la pantalla muestra el símbolo P (fig. 5b). Para desactivar la función de pre-caentamiento, girar nuevamente el botón esférico de regulación de la temperatura del agua sanitaria al símbolo ☺. Colocar nuevamente el botón esférico de regulación de la temperatura del agua sanitaria en la posición deseada. La función no se activa con la caldera en estado OFF: selector de función (1 - fig. 1a) en "⏻" apagado (OFF).

#### Ciao S R.S.I.:

**Modo verano (sólo con el depósito de agua externo conectado):** girar el selector hacia el símbolo "summer" (verano) ☀ (fig. 2a) se activa la función tradicional y la caldera suministra agua a la temperatura establecida en el depósito externo de acumulación. En caso de que haya una petición de agua caliente sanitaria, la pantalla digital exhibirá la temperatura del sistema de agua caliente, el icono para indicar el suministro de agua caliente y el icono de la llama

**Modo invierno:** girando el selector de modo dentro de la zona marcada + y - (fig. 2b) la caldera suministra agua caliente para la calefacción y, si está conectada al depósito externo de acumulación, agua caliente sanitaria. Si se solicita calefacción, la caldera se enciende y el monitor digital señala la temperatura de calentamiento del agua, el icono para indicar la calefacción y el icono de llama (fig. 3a). En caso de que haya una petición de agua caliente sanitaria la caldera se enciende y la pantalla digital exhibirá la temperatura del sistema de agua caliente, el icono para indicar el suministro de agua caliente y el icono de la llama (fig. 4a).

Regular el termostato ambiente en la temperatura deseada (~20°C)

### Ciao S C.S.I.: Regulación de la temperatura del agua caliente sanitaria

Para regular la temperatura del agua sanitaria (baños, ducha, cocina, etc.), girar el pomo con el símbolo "☀" (fig. 2b) dentro de la zona marcada + y -.

La caldera queda en estado standby hasta que, luego de que haya una petición de calefacción, la caldera se enciende y la pantalla digital exhibirá la temperatura del sistema de agua caliente, el icono para indicar el suministro de agua caliente y el icono de la llama

La caldera permanecerá en funcionamiento hasta alcanzar las temperaturas reguladas, luego de lo cual volverá al estado de "standby".

Si en el panel de mandos se enciende el indicador rojo en correspondencia del símbolo "⚠", significa que la caldera está en estado de parada temporal (ver el capítulo señalizaciones luminosas y anomalías). La pantalla digital muestra el código de la anomalía detectado (fig. 6a).

### Ciao S R.S.I.: Regulación de la temperatura del agua sanitaria

**CASO A** solo calefacción - regulación no aplicable

**CASO B** solo calentamiento + calentador externo con termostato - regulación no aplicable.

**CASO C** solo calentamiento + calentador externo con sonda - para regular la temperatura del agua caliente sanitaria en el calentador, gire el pomo, pero con el símbolo en sentido horario para aumentar la temperatura del agua y en sentido anti-horario para disminuirla.

La caldera queda en estado standby hasta que, luego de que haya una petición de calefacción, la caldera se enciende y la pantalla digital exhibirá la temperatura del sistema de agua caliente, el icono para indicar el suministro de agua caliente y el icono de la llama

La caldera permanecerá en funcionamiento hasta alcanzar las temperaturas reguladas, luego de lo cual volverá al estado de "standby".

Si en el panel de mandos se enciende el indicador rojo en correspondencia del símbolo "⚠", significa que la caldera está en estado de parada temporal (ver el capítulo señalizaciones luminosas y anomalías). La pantalla digital muestra el código de la anomalía detectado (fig. 6a)

### Ciao S C.S.I. - Ciao S R.S.I.: Función Sistema Automático Regulación Ambiente (S.A.R.A.) fig. 7a

Colocando el selector de temperatura del agua de calefacción en la zona marcada con la leyenda AUTO - valor de temperatura de 55 a 65°C - se activa el sistema de autorregulación S.A.R.A.: la caldera modifica la temperatura de envío en función de la señal de cierre del termostato ambiente. Cuando se alcanza la temperatura establecida con el selector de temperatura del agua de calefacción, inicia un conteo de 20 minutos. Si durante este período el termostato ambiente continua solicitando calor, el valor de la temperatura establecida aumenta automáticamente 5 °C. Al alcanzar el nuevo valor establecido, comienza un conteo de otros 20 minutos.

Si durante este período el termostato ambiente continua solicitando calor, el valor de la temperatura establecida aumenta automáticamente otros 5 °C.

Este nuevo valor de temperatura es el resultado de la temperatura establecida manualmente con el selector de temperatura de agua de calefacción y el aumento de +10 °C de la función S.A.R.A.

Luego del segundo ciclo, la temperatura debe mantenerse a un valor establecido de +10°C hasta que se haya satisfecho la petición del termostato ambiental.

### 4.3 Apagado

#### Apagado temporáneo

En caso de breves ausencias, colocar el selector de modo (1 - fig. 1a) en "⏻" (OFF).

De este modo dejando activas la alimentación eléctrica y la alimentación del combustible, la caldera estará protegida por los sistemas:

- **Función antihielo:** cuando la temperatura del agua de la caldera desciende por debajo de los 5°C se activa el circulador y el quemador (de ser necesario) a la mínima potencia para llevar la temperatura del agua a valores de seguridad (35°C). Durante el ciclo antihielo en la pantalla digital se muestra el símbolo ❄.
- **Función antibloqueo circulador:** un ciclo de funcionamiento se activa cada 24 horas.
- **Función antihielo sanitario (solo con conexión a un calentador externo con sonda):** la función se activa si la temperatura detectada por la sonda calentador desciende por debajo de 5°C. En esta fase se genera una solicitud de calor con encendido del quemador a la mínima potencia, que se mantiene hasta que la temperatura del agua en envío alcanza los 55°C. Durante el ciclo antihielo en la pantalla digital se muestra el símbolo ❄.

#### Apagado durante periodos largos

En caso de ausencias prolongadas, colocar el selector de modo (1 - fig. 1a) en "⏻" (OFF).



Luego, cerrar el grifo del gas presente en la instalación. En este caso, la función antihielo quedará desactivada: Vaciar las instalaciones si hubiese riesgo de hielo.

#### 4.4 Señalizaciones luminosas y anomalías

















El estado de funcionamiento de la caldera puede verse en la pantalla digital, a continuación hay una lista de los tipos de pantallas.

**Para restablecer el funcionamiento (desbloqueo alarmas):**

##### Anomalías A 01-02-03

Colocar el selector de función en  apagado (OFF), esperar 5-6 segundos y configurarlo en la posición deseada  (modo verano) o  (modo invierno).



Si los intentos de desbloqueo no vuelven a activar la caldera, solicitar la intervención del Servicio Técnico de Asistencia.

ESTADO DE LA CALDERA	PANTALLA
Stand-by	-
Estado APAGADO (OFF)	OFF
Módulo ACF de bloqueo de alarma	A01 
Alarma de desperfecto electrónico ACF	A01 
Alarma termostato límite	A02 
Alarma presostato aire	A03 
Alarma presostato H2O	A04 
Desperfecto agua caliente sanitaria NTC (C.S.I. y R.S.I solo con calefacción de acumulación externa con sonda)	A06 
Desperfecto de calefacción NTC	A07 
Llama parásita	A11 
Regulación eléctrica de la calefacción mínima y máxima	ADJ 
Espera transitoria de encendido	88°C parpadeante
Intervención presostato aire	 parpadeante
intervención presostato H2O	 parpadeante
Función de pre-calentamiento activa (sólo C.S.I.)	P
Solicitud de calefacción pre-calentamiento (sólo C.S.I.)	P parpadeante
Sonda externa presente	
Solicitud de calefacción para aguas sanitarias	60°C 
Solicitud de calefacción para calentamiento	80°C 
Solicitud de calefacción antihielo	
Llama presente	

##### Anomalía A 04

La pantalla digital visualiza además del código anomalía, el símbolo . Controlar el valor de presión que indica el hidrómetro:

si se encuentra en menos de 0,3 bares, ubicar el selector de función en apagado  (OFF) y regular el grifo de llenado (L fig. 13 para C.S.I. - externo para R.S.I.) hasta que la presión alcance un valor entre 1 y 1,5 bares.

Luego girar el selector de modo en la posición deseada  (verano) o  (invierno).

La caldera realizará un ciclo de purga de aproximadamente 2 minutos. Si los descensos de presión son frecuentes, solicitar la intervención del Servicio Técnico de Asistencia.

##### Desperfecto A 06 (sólo C.S.I.)

La caldera funciona normalmente, pero no puede mantener de modo fiable la estabilidad de la temperatura del agua caliente sanitaria que queda programada a una temperatura próxima a los 50°C. Se requiere la intervención del Servicio de Asistencia Técnica.

##### Anomalía A 07

Se requiere la intervención del Servicio de Asistencia Técnica.

#### 4.5 Regulaciones

La caldera ha sido regulada en fábrica por el fabricante.

Si fuese necesario realizar nuevamente regulaciones, por ejemplo después de un mantenimiento extraordinario, después de la sustitución de la válvula del gas o bien después de una transformación de gas, seguir los procedimientos que se indican a continuación.

 **Las regulaciones de la máxima potencia deben ser realizadas en la secuencia indicada y exclusivamente por personal cualificado.**

- retirar la cubierta, desenroscando los tornillos de fijación A (fig. 6)
- desenroscar aprox. dos vueltas el tornillo de toma de presión ubicado después de la válvula gas y conectar el manómetro
- desconectar la toma de compensación de la caja de aire

##### 4.5.1 Ciao S C.S.I.: Regulación de la máxima potencia y del mínimo agua caliente sanitaria

- Abrir completamente el grifo del agua caliente
- en el panel de mandos:
  - llevar el selector de modo a  (verano) (fig. 2a)
  - llevar al valor máximo el selector de temperatura del agua caliente sanitaria (fig. 8a)
- alimentar eléctricamente la caldera colocando el interruptor general de la instalación en "encendido"
- controlar que la presión leída en el manómetro sea estable; o bien con la ayuda de un miliamperímetro suministrado con el modulador, asegurarse de que se suministre la máxima corriente disponible al modulador (120 mA para G20 y 165 mA para GPL).
- quitar el capuchón de protección de los tornillos de regulación utilizando un destornillador (fig. 15)
- con una llave de horquilla CH10 girar la tuerca de la máxima potencia para obtener el valor indicado en la tabla "Datos técnicos"
- desconectar el faston del modulador
- esperar a que la presión leída en el manómetro se estabilice en el valor mínimo
- con una llave Allen, prestando atención de no presionar el eje interno, girar el tornillo rojo de regulación del mínimo agua caliente sanitaria y regular hasta leer en el manómetro el valor indicado en la tabla "Datos técnicos"
- conectar nuevamente el faston del modulador
- cerrar el grifo del agua caliente sanitaria
- colocar nuevamente con cuidado y atención el capuchón de protección de los tornillos de regulación.

##### Ciao S R.S.I.: Regulación de la potencia máxima y mínima

- Establecer el selector de función en  (invierno) (fig. 2b)
- Retirar la carcasa y acceder a la tarjeta
- Insertar los jumpers JP1 y JP2
- Llevar el trimmer P2 hasta el valor máximo, utilizando un destornillador (girar en sentido horario)
- Alimentar eléctricamente la caldera colocando el interruptor general de la instalación en "encendido"
- Controlar que la presión leída en el manómetro sea estable; o bien con la ayuda de un miliamperímetro suministrado con el modulador, asegurarse de que se suministre la máxima corriente disponible al modulador (120 mA para G20 y 165 mA para GPL)
- Utilizar un destornillador para quitar con cuidado el capuchón de protección de los tornillos de regulación
- con una llave de horquilla CH10, girar la tuerca de regulación de la máxima potencia para obtener el valor indicado en la tabla "Datos técnicos"
- Desconectar el faston del modulador
- Esperar a que la presión leída en el manómetro se estabilice en el valor mínimo
- Con una llave Allen girar el tornillo rojo de regulación de la potencia mínima, calibrar hasta leer en el manómetro el valor indicado en la tabla "Datos técnicos"
- Conectar nuevamente el faston del modulador
- Desconectar la alimentación de energía de la caldera
- Retirar los jumpers JP1 y JP2
- Colocar nuevamente con cuidado y atención el capuchón de protección de los tornillos de regulación.

##### 4.5.2 Regulación eléctrica de la mínima y máxima calefacción

 La función "regulación eléctrica" se activa y desactiva únicamente desde el jumper (JP1) (fig. 16).

El ADJ  se muestra en la pantalla para indicar que el procedimiento de regulación está en curso.

La habilitación de la función puede realizarse de las siguientes maneras:

- alimentando la tarjeta con el jumper JP1 activado y el selector de modo en posición invierno, independientemente de la eventual presencia de otras solicitudes de funcionamiento.
- activando el jumper JP1, con el selector de modo en posición invierno, sin solicitud de calor en curso.

⚠ La activación de la función prevé el encendido del quemador mediante la simulación de una solicitud de calor en calefacción.

Para realizar las operaciones de regulación, proceder de la siguiente manera:

- apagar la caldera
- retirar la cubierta y acceder a la tarjeta
- insertar el jumper JP1 (fig. 16) para habilitar los pomos ubicados en el panel de mandos para las funciones de regulación de la calefacción mínima y máxima.
- asegurarse de que el selector de modo esté en posición invierno (ver el apartado 4.2).
- conectar la alimentación eléctrica de la caldera

#### ⚠ Tarjeta eléctrica con tensión (230 Volt)

- girar el pomo de regulación de la temperatura del agua de calefacción **B** (fig. 17) hasta obtener el valor de mínima calefacción como se indica en la tabla multigas
  - insertar el jumper JP2 (fig. 16)
  - girar el pomo de regulación de la temperatura del agua caliente sanitaria **C** (fig. 17) hasta obtener el valor de máxima calefacción como se indica en la tabla multigas
  - retirar el jumper JP2 para memorizar el valor de máxima calefacción
  - **retirar el jumper JP1 para memorizar el valor de mínima calefacción y para salir del procedimiento de regulación**
  - conectar nuevamente la toma de compensación a la caja de aire
- Desconectar el manómetro y enroscar nuevamente el tornillo de la toma de presión.

⚠ Para finalizar la función de regulación sin la memorización de los valores establecidos operar de la siguiente manera:

- a) llevar el selector de modo a la posición  (OFF)
- b) quitar la tensión de alimentación
- c) retirar JP1/JP2

⚠ La función de regulación finaliza automáticamente, sin la memorización de los valores de mínima y máxima, transcurridos 15 minutos de su activación.

⚠ La función concluye automáticamente aún en caso de parada o bloqueo definitivo.  
Aún en este caso la finalización de la función NO prevé la memorización de los valores.

#### Nota:

Para realizar la regulación sólo de la máxima calefacción, se puede retirar el jumper JP2 (para memorizar la máxima) y luego salir de la función, sin memorizar la mínima, llevando el selector de modo a  (OFF) o quitando la tensión a la caldera.

⚠ Después de cada intervención realizada en el órgano de regulación de la válvula del gas, sellarlo nuevamente con laca selladora.

Cuando se finaliza la regulación:

- con el termostato ambiente, volver a colocar la temperatura programada en la deseada
- llevar el selector de la temperatura del agua de la calefacción a la posición deseada
- cerrar el panel de mandos
- volver a montar la cubierta.

## 4.6 Transformación del gas

La transformación de un gas de una familia a un gas de otra familia puede realizarse fácilmente aún con la caldera instalada.

La caldera se entrega para funcionar con gas metano (G20) de acuerdo a lo que indica la placa del producto.

Existe la posibilidad de transformar las calderas de un tipo de gas a otro utilizando los correspondientes kit que se entregan a pedido:

- kit de transformación a Metano
- kit de transformación a GPL

Para el desmontaje remitirse a las instrucciones indicadas a continuación:

- desconectar la alimentación eléctrica de la caldera y cerrar el grifo del gas
- retirar luego: cubierta, tapa de la caja de distribución del aire y tapa de la cámara de combustión (fig. 19)
- desconectar el cable bujía
- sacar el pasacable inferior de la sede de la caja de aire
- quitar los tornillos de fijación del quemador y retirarlo con la bujía montada y los correspondientes cables
- utilizando una llave tubo o de horquilla, retirar las boquillas y las arandelas y sustituirlas por las del kit.

⚠ **Utilizar y montar taxativamente las arandelas contenidas en el kit incluso en el caso de colectores sin arandelas.**

- volver a montar el quemador en la cámara de combustión y atornillar los tornillos que lo fijan al colector del gas
- colocar el pasacable con el cable bujía en su sede en la caja de aire
- restablecer la conexión del cable bujía
- volver a montar la tapa de la cámara de combustión y la tapa de la caja de aire
- volcar el panel de mandos hacia la parte frontal de la caldera
- abrir la tapa de la tarjeta
- en la tarjeta de control (fig. 16):
  - si se trata de transformación de gas metano en GPL, insertar el jumper en la posición JP3
  - si se trata de transformación de GPL en gas metano, quitar el conector puente de la posición JP3
- volver a montar los componentes anteriormente desmontados
- volver a dar tensión a la caldera y abrir el grifo del gas (con la caldera en funcionamiento, comprobar la correcta estanqueidad de las juntas del circuito de alimentación del gas).

⚠ **La transformación tiene que ser realizada sólo por personal cualificado.**

⚠ **Una vez efectuada la transformación, regular nuevamente la caldera llevando a cabo todo lo indicado en el apartado específico y aplicar la nueva placa de identificación contenida en el kit.**

## 5 MANTENIMIENTO

Para garantizar que se mantengan las características de funcionalidad y eficiencia del producto y para respetar las prescripciones de la legislación vigente, se debe someter el aparato a controles sistemáticos en intervalos regulares.

La frecuencia de los controles depende de las particulares condiciones de instalación y de uso. De todas formas recomendamos realizar como mínimo un control anual por parte del personal autorizado de los Centros de Asistencia Técnica.

Apagar el aparato en caso de mantenimiento de estructuras situadas cerca de los conductos de los humos u otros dispositivos y sus accesorios. Una vez terminados los trabajos, personal calificado deberá comprobar que conductos y dispositivos funcionen correctamente.

**IMPORTANTE:** antes de iniciar cualquier operación de limpieza o de mantenimiento del aparato, desconecte el interruptor del aparato y de la instalación para interrumpir la alimentación eléctrica y cierre la alimentación del gas por medio de la llave situada en la caldera.

No limpiar el aparato o sus diferentes piezas con sustancias inflamables (por ej., bencina, alcohol, etc.).

No limpiar los paneles, las partes pintadas y las piezas de plástico con diluyente para pinturas.

La limpieza de los paneles debe realizarse solamente con agua y jabón.

### 5.1 Control de los parámetros de combustión

#### Ciao S C.S.I.:

Para efectuar el análisis de la combustión, se deben efectuar las siguientes operaciones:

- abrir completamente un grifo del agua caliente
- llevar el selector de modo en verano  y el selector de la temperatura del agua caliente sanitaria al valor máximo (fig. 8a).
- retirar el tornillo de la tapa de la toma de análisis de combustión (fig. 18) e insertar las sondas
- conectar la alimentación eléctrica de la caldera

#### Ciao S R.S.I.:

- apagar la caldera
- colocar el selector de función en modo invierno
- retirar la carcasa y acceder a la tarjeta
- insertar los jumpers JP1 y JP2
- utilizar un destornillador para abrir el tapón en el panel de control
- llevar el trimmer P2 hasta el valor máximo, utilizando un destornillador (girar en sentido horario)
- retirar el tornillo de la tapa de la toma de análisis de combustión (fig. 18) e insertar las sondas
- conectar la alimentación eléctrica de la caldera

El aparato funciona a la misma potencia y se puede realizar el control de la combustión.

Una vez concluido el análisis:

- cerrar el grifo del agua caliente
- retirar la sonda del analizador y cerrar la toma de análisis de la combustión, fijando atentamente el tornillo que se extrajo con anterioridad.

## USUARIO

### 1A ADVERTENCIAS GENERALES Y DISPOSITIVOS DE

#### SEGURIDAD

El manual de instrucciones forma parte integrante del producto, por lo que debe conservarse con cuidado y debe acompañar siempre al aparato; en el caso de pérdida o de daños, se puede solicitar otra copia al Centro de Asistencia Técnica.

- ⚠ La instalación de la caldera y cualquier otra intervención de asistencia y de mantenimiento, deben ser realizadas por personal cualificado según las normas locales y nacionales vigentes.
- ⚠ Para la instalación se aconseja dirigirse a personal especializado.
- ⚠ La caldera solo debe ser utilizada para la aplicación prevista por el fabricante. El fabricante no se hace responsable por los daños a personas, animales o cosas debido a errores en la instalación, regulación, mantenimiento o uso inadecuado.
- ⚠ Los dispositivos de seguridad o de regulación automática de los aparatos, durante toda la vida de la instalación, no tienen que ser modificados si no es por parte del fabricante o del proveedor.
- ⚠ Este aparato sirve para producir agua caliente; por lo tanto se debe conectar a una instalación de calefacción y/o a una red de distribución de agua caliente sanitaria, que sea compatible con sus prestaciones y su potencia..
- ⚠ En el caso de pérdidas de agua se debe cerrar la alimentación hídrica y avisar inmediatamente al personal del Centro de Asistencia Técnica.
- ⚠ En el caso de ausencia prolongada, cerrar la llave de alimentación del gas y apagar el interruptor general de alimentación eléctrica. En el caso de que se prevea riesgo de heladas, vaciar el agua contenida en la caldera.
- ⚠ Controlar periódicamente que la presión de funcionamiento de la instalación hidráulica no descienda por debajo del valor de 1 bar.
- ⚠ En el caso de desperfecto o de funcionamiento incorrecto del aparato, apagarlo, sin realizar ningún intento de reparación o de intervención directa.
- ⚠ El mantenimiento del aparato se aconseja realizarlo al menos una vez al año programarla con tiempo con el Centro de Asistencia Técnica, lo que evitará desperdiciar tiempo y dinero.

El uso de la caldera requiere el respeto absoluto de algunas reglas de seguridad fundamentales:

- ⊖ No utilizar el aparato para fines diferentes para los que está destinado.
- ⊖ Es peligroso tocar el aparato con partes del cuerpo mojadas o húmedas y/o con pies descalzos.
- ⊖ Está absolutamente tapar con trapos, papeles o cualquier otro elemento las rejillas de aspiración y de salida de los productos de la combustión, así como la apertura de ventilación del local donde está instalado el aparato.
- ⊖ Si se advierte olor a gas, no accionar interruptores eléctricos, teléfono y cualquier otro objeto que pueda provocar chispas. Ventilar el local abriendo puertas y ventanas, y cerrar el grifo general de gas.
- ⊖ No apoyar objetos en la caldera.
- ⊖ Se desaconseja cualquier operación de limpieza con el aparato conectado a la red de alimentación eléctrica.
- ⊖ No tapar o reducir la superficie de las entradas de aire del local donde está instalado el aparato.
- ⊖ No dejar contenedores y sustancias inflamables en el local donde esté instalado el aparato.
- ⊖ Se desaconseja cualquier intento de reparación en caso de desperfecto y/o de funcionamiento incorrecto del aparato.
- ⊖ Es peligroso estirar o doblar los cables eléctricos.
- ⊖ Se desaconseja el uso del aparato por parte de niños o personas inexpertas.
- ⊖ Está prohibido intervenir en los elementos sellados.

Para un mejor uso, recordar que:

- una limpieza externa periódica con agua y jabón, además de mejorar el aspecto estético, preservar los paneles de la corrosión, alargando la vida de la caldera;
- en caso de que la caldera mural se instale entre muebles colgantes, se debe dejar un espacio de al menos 5 cm por cada lado para la ventilación y para permitir el mantenimiento;
- la instalación de un termostato ambiente favorecerá un mayor confort, una utilización más racional del calor y un ahorro energético; la caldera además puede ser conectada a un cronotermostato para programar encendidos y apagados durante el día o la semana.

### 2A ENCENDIDO

El primer encendido de la caldera debe ser efectuado por personal del Centro de Asistencia Técnica. A continuación, cuando sea necesario volver a poner en funcionamiento el aparato, seguir detenidamente las operaciones descritas.

Para el encendido de la caldera se deben realizar las siguientes operaciones:

- encender la caldera
- abrir el grifo de gas presente en la instalación para permitir el flujo de combustible
- colocar el selector de modo (1 - fig. 1a) en la posición deseada:

**Ciao S C.S.I.:**

**Modo verano:** girando el selector en el símbolo verano "☀" (fig. 2a) se activa la función tradicional de sólo agua caliente sanitaria. En caso de que haya una petición de agua caliente sanitaria la pantalla digital exhibirá la temperatura del sistema de agua caliente, el icono para indicar el suministro de agua caliente y el icono de la llama

**Modo invierno:** girando el selector de modo dentro de la zona marcada + y - (fig. 2b), la caldera suministra agua caliente sanitaria y calefacción. Si se solicita calefacción, la caldera se enciende y el monitor digital señala la temperatura de calentamiento del agua, el icono para indicar la calefacción y el icono de llama (fig. 3a). En caso de que haya una petición de agua caliente sanitaria, la caldera se enciende y la pantalla digital exhibirá la temperatura del sistema de agua caliente, el icono para indicar el suministro de agua caliente y el icono de la llama (fig. 4a)

**Precalentamiento (agua caliente más rápido):** girar el pomo de regulación de temperatura del agua caliente sanitaria (2 - fig. 1a) al símbolo ☺ (fig. 5a), para activar la función de pre-calentamiento. Esta función permite mantener caliente el agua presente en intercambiador sanitario para reducir los tiempos de espera durante los suministros. Cuando se habilita la función de pre-calentamiento, la pantalla indica la temperatura de alimentación del agua de calentamiento o del agua caliente sanitaria según la solicitud en curso. Durante el encendido del quemador, después de una solicitud de precalentamiento, la pantalla muestra el símbolo P (fig. 5b). Para desactivar la función de precalentamiento, girar nuevamente el botón esférico de regulación de la temperatura del agua caliente sanitaria al símbolo ☺. Colocar nuevamente el botón esférico de regulación de la temperatura del agua sanitaria en la posición deseada. La función no se activa con la caldera en estado OFF: selector de función (1 - fig. 1a) en "⏻" apagado (OFF).

**Ciao S R.S.I.:**

**Modo verano (sólo con el depósito de agua externo conectado):** girando el selector en el símbolo verano "☀" (fig. 2a), se activa la función tradicional de sólo agua caliente sanitaria y la caldera suministra agua a la temperatura establecida en el depósito externo de acumulación. En caso de que haya una petición de agua caliente sanitaria, la pantalla digital exhibirá la temperatura del sistema de agua caliente, el icono para indicar el suministro de agua caliente y el icono de la llama

**Modo invierno:** girando el selector de modo dentro de la zona marcada + y - (fig. 2b) la caldera suministra agua caliente para la calefacción y, si está conectada al depósito externo de acumulación, agua caliente sanitaria. Si se solicita calefacción, la caldera se enciende y el monitor digital señala la temperatura de calentamiento del agua, el icono para indicar la calefacción y el icono de llama (fig. 3a). En caso de que haya una petición de agua caliente sanitaria, la caldera se enciende y la pantalla digital exhibirá la temperatura del sistema de agua caliente, el icono para indicar el suministro de agua caliente y el icono de la llama (fig. 4a).

Regular el termostato ambiente en la temperatura deseada (~20°C)

**Ciao S C.S.I.: Regulación de la temperatura del agua caliente sanitaria**

Para regular la temperatura del agua sanitaria (baños, ducha, cocina, etc.), girar el pomo con el símbolo "☀" (fig. 2b) dentro de la zona marcada + y -. La caldera queda en estado standby hasta que, luego de que haya una petición de calefacción, la caldera se enciende y la pantalla digital exhibirá la temperatura del sistema de agua caliente, el icono para indicar el suministro de agua caliente y el icono de la llama. La caldera permanecerá en funcionamiento hasta alcanzar las temperaturas reguladas, luego de lo cual volverá al estado de "standby". Si en el panel de mandos se enciende el indicador rojo en correspondencia del símbolo "⚠", significa que la caldera está en estado de parada temporal (ver el capítulo señalizaciones luminosas y anomalías). La pantalla digital muestra el código de la anomalía detectado (fig. 6a).

**Ciao S R.S.I.: Regulación de la temperatura del agua sanitaria**

**CASO A** sólo calefacción - regulación no aplicable

**CASO B** sólo calentamiento + calentador externo con termostato - regulación no aplicable.

**CASO C** sólo calentamiento + calentador externo con sonda - para regular la temperatura del agua caliente sanitaria en el calentador, gire



el pomo, pero con el símbolo en sentido horario para aumentar la temperatura del agua y en sentido anti-horario para disminuirla.

La caldera queda en estado standby hasta que, luego de que haya una petición de calefacción, la caldera se enciende y la pantalla digital exhibirá la temperatura del sistema de agua caliente, el icono para indicar el suministro de agua caliente y el icono de la llama

La caldera permanecerá en funcionamiento hasta alcanzar las temperaturas reguladas, luego de lo cual volverá al estado de "standby".

Si en el panel de mandos se enciende el indicador rojo en correspondencia del símbolo "A", significa que la caldera está en estado de parada temporal (ver el capítulo señalizaciones luminosas y anomalías). La pantalla digital muestra el código de la anomalía detectado (fig. 6a)

#### Ciao S C.S.I. - Ciao S R.S.I.: Función Sistema Automático Regulación Ambiente (S.A.R.A.) fig. 7a

Colocando el selector de temperatura del agua de calefacción en la zona marcada con la leyenda AUTO - valor de temperatura de 55 a 65°C - se activa el sistema de autorregulación S.A.R.A.: la caldera modifica la temperatura de envío en función de la señal de cierre del termostato ambiente. Cuando se alcanza la temperatura establecida con el selector de temperatura del agua de calefacción, inicia un conteo de 20 minutos. Si durante este período el termostato ambiente continua solicitando calor, el valor de la temperatura establecida aumenta automáticamente 5 °C. Al alcanzar el nuevo valor establecido, comienza un conteo de otros 20 minutos.

Si durante este período el termostato ambiente continua solicitando calor, el valor de la temperatura establecida aumenta automáticamente otros 5 °C.

Este nuevo valor de temperatura es el resultado de la temperatura establecida manualmente con el selector de temperatura de agua de calefacción y el aumento de +10 °C de la función S.A.R.A.



Luego del segundo ciclo, la temperatura debe mantenerse a un valor establecido de +10°C hasta que se haya satisfecho la petición del termostato ambiental.

### 3A APAGADO

#### Apagado temporáneo

En caso de breves ausencias, colocar el selector de modo (1 - fig. 1a) en  (OFF).

De este modo dejando activas la alimentación eléctrica y la alimentación del combustible, la caldera estará protegida por los sistemas:

- **Función antihielo:** cuando la temperatura del agua de la caldera desciende por debajo de los 5°C se activa el circulador y el quemador (de ser necesario) a la mínima potencia para llevar la temperatura del agua a valores de seguridad (35°C). Durante el ciclo antihielo en la pantalla digital se muestra el símbolo .
- **Función antibloqueo circulador:** un ciclo de funcionamiento se activa cada 24 horas.
- **Función antihielo sanitario (solo con conexión a un calentador externo con sonda):** la función se activa si la temperatura detectada por la sonda calentador desciende por debajo de 5°C. En esta fase se genera una solicitud de calor con encendido del quemador a la mínima potencia, que se mantiene hasta que la temperatura del agua en envío alcanza los 55°C. Durante el ciclo antihielo en la pantalla digital se muestra el símbolo .

#### Apagado durante períodos largos

En caso de ausencias prolongadas, colocar el selector de modo (1 - fig. 1a) en  (OFF).

Luego, cerrar el grifo del gas presente en la instalación. En este caso, la función antihielo quedará desactivada. Vaciar las instalaciones si hubiese riesgo de hielo.

### 4A CONTROLES

Asegurarse al comienzo de la estación de calefacción y también periódicamente durante la utilización, que el hidrómetro-termohidrómetro indique valores de presión con la instalación en frío, comprendidos entre 0,6 y 1,5 bar: esto evita el ruido de la instalación debido a la presencia de aire. En caso de circulación insuficiente de agua, la caldera se apagará. En ningún caso la presión del agua deberá ser inferior a 0,5 bar (campo rojo).

En el caso en que se produzca esta situación, se debe restablecer la presión del agua en la caldera procediendo de la siguiente manera:

- colocar el selector de modo (2 - fig. 1a) en  OFF
- abrir el grifo de llenado (L fig. 13 para C.S.I. - externo para R.S.I.) hasta que la presión se encuentre entre 1 y 1,5 bares.





















Cerrar bien el grifo.

Volver a colocar el selector de modo en la posición inicial.

Si la disminución de la presión es muy frecuente, solicitar la intervención del Centro de Asistencia Técnica.



### 5A SEÑALIZACIONES LUMINOSAS Y ANOMALÍAS

El estado de funcionamiento de la caldera se indica en el visor digital, a continuación detallamos los tipos de visualización.

ESTADO DE LA CALDERA	PANTALLA
Stand-by	-
Estado APAGADO (OFF)	OFF
Bloqueo de alarma de módulo ACF	A01  
Alarma de desperfecto eléctrico ACF	A01  
Alarma termostato límite	A02 
Alarma presostato aire	A03 
Alarma presostato H2O	A04  
Desperfecto agua caliente sanitaria NTC (C.S.I. y R.S.I sólo con calefacción de acumulación externa con sonda)	A06 
Desperfecto de calefacción NTC	A07 
Llama parásita	A11 
Regulación eléctrica de la calefacción mínima y máxima	ADJ 
Espera transitoria de encendido	88°C parpadeante
Intervención presostato aire	 parpadeante
Intervención presostato H2O	  parpadeante
Función de pre-calentamiento activa (sólo C.S.I.)	P
Solicitud de calefacción pre-calentamiento (sólo C.S.I.)	P parpadeante
Sonda externa presente	
Solicitud de agua caliente sanitaria	60°C 
Solicitud de calefacción para calentamiento	80°C 
Solicitud de calefacción antihielo	
Llama presente	

#### Para restablecer el funcionamiento (desbloqueo alarmas):

##### Anomalías A 01-02-03



Colocar el selector de modo en  apagado (OFF), esperar 5-6 segundos y configurarlo en la posición deseada  (modo verano) o  (modo invierno).

Si los intentos de desbloqueo no vuelven a activar la caldera, solicitar la intervención del Servicio Técnico de Asistencia.

##### Anomalía A 04

La pantalla digital visualiza además del código anomalía, el símbolo . Controlar el valor de presión que indica el hidrómetro:

si se encuentra en menos de 0,3 bares, ubicar el selector de función en apagado  (OFF) y regular el grifo de llenado (L fig. 13 para C.S.I. - externo para R.S.I.) hasta que la presión alcance un valor de entre 1 y 1,5 bares.

Luego girar el selector de modo en la posición deseada  (verano) o  (invierno).

La caldera realizará un ciclo de purga de aproximadamente 2 minutos. Si los descensos de presión son frecuentes, solicitar la intervención del Servicio Técnico de Asistencia.

##### Desperfecto A 06 (sólo C.S.I.)

La caldera funciona normalmente, pero no puede mantener de modo fiable la estabilidad de la temperatura del agua sanitaria que queda programada a una temperatura próxima a los 50°C. Se requiere la intervención del Servicio de Asistencia Técnica.

##### Anomalía A 07

Se requiere la intervención del Servicio de Asistencia Técnica.

**DATOS TÉCNICOS**

DESCRIPCIÓN			CIAO 20 S C.S.I.	CIAO 24 S C.S.I.	CIAO 24 S R.S.I.
<b>Calefacción</b>	Entrada de calor	kW	22,20	25,80	25,80
		kcal/h	19.092	22.188	22.188
	Potencia térmica máxima	kW	20,60	23,94	23,94
		kcal/h	17.717	20.590	20.590
	Entrada mínima de calor	kW	7,00	8,90	8,90
		kcal/h	6.020	7.654	7.654
Potencia térmica mínima	kW	5,88	7,61	7,61	
	kcal/h	5.057	6.544	6.544	
<b>ACS</b>	Entrada de calor	kW	22,20	25,80	-
		kcal/h	19.092	22.188	-
	Potencia térmica máxima	kW	20,60	23,94	-
		kcal/h	17.717	20.590	-
	Entrada mínima de calor	kW	7,00	8,90	-
		kcal/h	6.020	7.654	-
Potencia térmica mínima	kW	5,88	7,61	-	
	kcal/h	5.057	6.544	-	
Rendimiento útil Pn máx - Pn mín		%	92,8 - 84,0	92,8 - 85,5	92,8 - 85,5
Rendimiento útil 30% (47° retorno)		%	91,9	90,9	90,9
Rendimiento de combustión		%	93,2	93,0	93,0
Energía eléctrica		W	100	116	116
Categoría			II2H3+	II2H3+	II2H3+
País de destino			-	-	-
Tensión de alimentación eléctrica		V - Hz	230-50	230-50	230-50
Grado de protección		IP	X5D	X5D	X5D
Pérdidas en la chimenea con quemador encendido		%	6,85	6,96	6,96
Pérdidas en la chimenea con quemador apagado		%	0,09	0,07	0,07
<b>Funcionamiento calefacción</b>					
Presión - temperatura máxima		bar-°C	3 - 90	3 - 90	3 - 90
Presión mínima para el funcionamiento estándar		bar	0,25 - 0,45	0,25 - 0,45	0,25 - 0,45
Campo de selección de la temperatura del agua caliente		°C	40/80	40/80	40/80
Bomba: altura de carga máxima disponible para la instalación		mbar	300	300	300
al caudal de		l/h	1.000	1.000	1.000
Vaso de expansión de membrana		l	7	8	8
Precarga del vaso de expansión		bar	1	1	1
<b>Funcionamiento sanitario</b>					
Presión máxima		bar	6	6	-
Presión mínima		bar	0,15	0,15	-
Cantidad de agua caliente con Δt 25°C		l/min	11,8	13,7	-
con Δt 30°C		l/min	9,8	11,4	-
con Δt 35°C		l/min	8,4	9,8	-
ACS potencia mínima		l/min	2	2	-
Campo de selección de la temperatura H2O sanitaria		°C	37/60	37/60	-
Limitador de caudal		l/min	8	10	-
<b>Presión gas</b>					
Presión nominal gas metano (G20)		mbar	20	20	20
Presión nominal gas líquido GPL (G30/G31)		mbar	28-30/37	28-30/37	28-30/37
<b>Conexiones hidráulicas</b>					
Entrada - salida calefacción		Ø	3/4"	3/4"	3/4"
Entrada - salida sanitario		Ø	1/2"	1/2"	-
Entrega - potencia interacumulador		Ø	-	-	3/4"
Entrada gas		Ø	3/4"	3/4"	3/4"
<b>Dimensiones de la caldera</b>					
Altura		mm	715	715	715
Anchura		mm	405	405	405
Profundidad a la cubierta		mm	248	248	248
Peso de la caldera		kg	29	31	28
<b>Caudal (G20)</b>					
Capacidad de aire		Nm³/h	36,875	39,613	39,613
Capacidad gas de escape		Nm³/h	39,101	42,204	42,204
Flujo másico de gas de escape (máx-mín)		gr/s	13,310 - 14,540	14,308-16,247	14,308-16,247
<b>Caudal (G30)</b>					
Capacidad de aire		Nm³/h	35,328	40,249	40,249
Capacidad gas de escape		Nm³/h	36,955	41,008	41,008
Flujo másico de gas de escape (máx-mín)		gr/s	13,100 - 14,030	13,985 - 16,429	13,985 - 16,429

DESCRIPCIÓN		CIAO 20 S C.S.I.	CIAO 24 S C.S.I.	CIAO 24 S R.S.I.	
<b>Caudal (G31)</b>					
Capacidad de aire	Nm <sup>3</sup> /h	36,405	40,454	40,454	
Capacidad gas de escape	Nm <sup>3</sup> /h	38,119	41,455	41,455	
Flujo másico de gas de escape (máx-mín)	gr/s	13,480 - 14,280	14,120 - 16,683	14,120 - 16,683	
<b>Rendimiento del ventilador</b>					
Prevalencia residual caldera sin tubos	Pa	43	110	110	
<b>Tubos concéntricos de evacuación de humos</b>					
Diámetro	mm	60-100	60 - 100	60 - 100	
Longitud máxima	m	4,25	4,25	4,25	
Pérdida por la introducción de una curva de 45°/90°	m	1 - 1,5	1 - 1,5	1 - 1,5	
Agujero en la pared (diámetro)	mm	105	105	105	
<b>Tubos concéntricos de evacuación de humos</b>					
Diámetro	mm	80-125	80-125	80-125	
Longitud máxima	m	12,40	12,4	12,4	
Pérdidas para una curva de 45°/90°	m	1,35 - 2,2	1,35 - 2,2	1,35 - 2,2	
Agujero en la pared (diámetro)	mm	130	130	130	
<b>Tubos separados de evacuación de humos</b>					
Diámetro	mm	80	80	80	
Longitud máxima	m	10 + 10	16 + 16	16 + 16	
Pérdidas para una curva de 45°/90°	m	1,2 - 1,7	1,2 - 1,7	1,2 - 1,7	
<b>Instalación B22P-B52P</b>					
Diámetro	mm	80	80	80	
Longitud máxima conducto de evacuación	m	14	25	25	
Clase NOx		3	3	3	
<b>Valores de emisiones con caudal máximo y mínimo con gas G20*</b>					
Máximo - Mínimo	CO s.a. inferior a	ppm	100 - 180	120 - 200	120 - 200
	CO <sub>2</sub>	%	7,1 - 2,0	7,3 - 2,2	7,3 - 2,2
	NOx s.a. más bajo que	ppm	180 - 100	200 - 100	200 - 100
	Temperatura humos	°C	127 - 97	142 - 109	142 - 109

\* Control realizado con tubo concéntrico Ø 60-100 - long. 0,85 m - temperatura agua 80-60°C

### Tabla Multigas

DESCRIPCIÓN		Gas metano (G20)			Butano (G30)			Propano (G31)		
		20 S C.S.I.	24 S C.S.I.	24 S R.S.I.	20 S C.S.I.	24 S C.S.I.	24 S R.S.I.	20 S C.S.I.	24 S C.S.I.	24 S R.S.I.
Índice de Wobbe inferior (a 15 °C-1013 mbar)	MJ/m <sup>3</sup> S	45,67			80,58			70,69		
Poder calorífico inferior	MJ/m <sup>3</sup> S	34,02			116,09			88		
Presión nominal de alimentación	mbar (mm W.C.)	20 (203,9)			28 - 30 (285,5 - 305,9)			37 (377,3)		
Presión mínima de suministro	mbar (mm W.C.)	13,5 (137,7)			-			-		
Quemador número de orificios	n°	11			11			11		
Quemador diámetro de orificios	mm	1,30	1,35	1,35	0,75	0,78	0,78	0,75	0,78	0,78
Caudal gas máximo calefacción	Sm <sup>3</sup> /h	2,35	2,73	2,73						
	kg/h				1,75	2,03	2,03	1,72	2,00	2,00
Caudal gas máximo agua sanitaria	Sm <sup>3</sup> /h	2,35	2,73	-						
	kg/h				1,75	2,03	-	1,72	2,00	-
Caudal gas mínimo calefacción	Sm <sup>3</sup> /h	0,74	0,94	0,94						
	kg/h				0,55	0,70	0,70	0,54	0,69	0,69
Caudal gas mínimo agua sanitaria	Sm <sup>3</sup> /h	0,74	0,94	-						
	kg/h				0,55	0,70	-	0,54	0,69	-
Presión máx después de la válvula en calefacción	mbar	10,40	11,80	11,80	28,00	27,80	27,80	36,00	35,80	35,80
	mm W.C.	106,05	120,33	120,33	285,52	283,48	283,48	367,10	365,06	365,06
Presión máx después de la válvula en agua sanitaria	mbar	10,40	11,80	-	28,00	27,80	-	36,00	35,80	-
	mm W.C.	106,05	120,33	-	285,52	283,48	-	367,10	365,06	-
Presión mín después de la válvula en calefacción	mbar	1,20	1,50	1,50	3,00	3,30	3,30	3,90	4,30	4,30
	mm W.C.	12,24	15,30	15,30	30,59	33,65	33,65	39,77	43,85	43,85
Presión mín después de la válvula en agua sanitaria	mbar	1,20	1,50	-	3,00	3,30	-	3,90	4,30	-
	mm W.C.	12,24	15,30	-	30,59	33,65	-	39,77	43,85	-

## 1 - ADVERTÊNCIAS E SEGURANÇAS

 As caldeiras produzidas nos nossos estabelecimentos são fabricadas com atenção dedicada também aos componentes específicos de modo a proteger tanto o utilizador quanto o instalador de eventuais acidentes. Recomenda-se, portanto, ao pessoal qualificado, depois de cada intervenção efectuada no produto, prestar atenção especial às conexões eléctricas, sobretudo no que se refere à parte desencapada dos condutores, que não deve de modo nenhum sair da régua de terminais, evitando assim o possível contacto com partes do corpo do próprio condutor.

 Este manual de instruções, juntamente com o do utilizador, constitui parte integrante do produto: certificar-se de que sempre acompanhe o aparelho, também em caso de cessão a outro proprietário ou utilizador ou de transferência em outra instalação. Em caso de dano ou extravio, solicitar um outro exemplar ao Centro de Assistência Técnica da zona.

 A instalação da caldeira e qualquer outra intervenção de assistência e de manutenção deve ser realizada por pessoal qualificado de acordo com as indicações das normas locais e nacionais vigentes.

 Recomenda-se ao instalador instruir o utilizador sobre o funcionamento do aparelho e sobre as normas fundamentais de segurança.

 Esta caldeira só deve ser utilizada para o uso para que foi concebida. O fabricante declina toda e qualquer responsabilidade contratual e extracontratual por danos em pessoas ou animais ou danos materiais decorrentes de erros cometidos durante o ajuste, a instalação e a manutenção e um uso indevido.

 Depois de tirar a embalagem, certificar-se da integridade e da totalidade do conteúdo. Em caso de não adequação, dirigir-se ao revendedor do qual adquiriu o aparelho.

 A descarga da válvula de segurança do aparelho deve ser conectada a um adequado sistema de recolha e evacuação. O fabricante do aparelho não é responsável por eventuais danos causados pela intervenção da válvula de segurança.

 Eliminar os materiais de embalagem nos recipientes apropriados nos específicos centros de recolha.

 Os resíduos devem ser eliminados sem perigo para a saúde das pessoas e sem usar procedimentos ou métodos que possam causar danos ao ambiente.

É necessário, durante a instalação, informar ao utilizador que:

- em caso de vazamentos de água deve fechar a alimentação hídrica e avisar com presteza o Centro de Assistência Técnica
- a pressão de funcionamento do sistema hidráulico deve estar entre 1 e 2 bar e, conseqüentemente, não deve exceder 3 bar. Se necessário, desbloqueie a pressão conforme indicado no parágrafo intitulado "Preenchendo o sistema"
- em caso de não utilização da caldeira por um longo período é recomendável a intervenção do Centro de Assistência Técnica para efectuar as seguintes operações:
  - desligue o interruptor principal do aparelho e o interruptor geral do sistema
  - fechar as torneiras do combustível e da água, tanto da instalação térmica quanto da sanitária
  - esvaziar a instalação térmica e sanitária se há risco de gelo
- a manutenção da caldeira deve ser feita pelo menos uma vez por ano. programando-a a tempo com o Serviço Técnico de Assistência.

Para a segurança convém lembrar que:

 É desaconselhado o uso da caldeira por parte de crianças ou de pessoas incapazes não assistidas.

 É perigoso accionar dispositivos ou aparelhos eléctricos, tais como interruptores, electrodomésticos, etc., caso se sinta cheiro

de combustível ou de combustão. Em caso de perdas de gás, arejar o local, abrindo portas e janelas; fechar a torneira geral do gás; solicitar com presteza a intervenção de pessoal profissionalmente qualificado do Centro de Assistência Técnica

 Não tocar a caldeira com os pés descalços e com partes do corpo molhadas ou húmidas

 Antes de efectuar operações de limpeza, desconectar a caldeira da rede de alimentação eléctrica posicionando o interruptor bipolar da instalação e o principal do painel de comando em "OFF"

 É proibido modificar os dispositivos de segurança ou de regulação sem a autorização ou as indicações do fabricante

 Não puxar, retirar, torcer os cabos eléctricos que saem da caldeira mesmo se esta estiver desconectada da rede de alimentação eléctrica

 Evitar tapar ou reduzir a dimensão das aberturas de ventilação do local de instalação

 Não deixar contentores e substâncias inflamáveis no local onde está instalado o aparelho

 Não deixar os elementos da embalagem ao alcance das crianças.

## 2 - DESCRIÇÃO DACALDEIRA

**Ciao S C.S.I.** é uma caldeira instalada na parede tipo C para aquecimento e produção de água quente sanitária: de acordo com o dispositivo de descarga de gases da chaminé, a caldeira é classificada nas categorias B22P, B52P, C12, C22, C32, C42, C52, C62, C82, C92, C12x, C32x, C42x, C52x, C62x, C82x, C92x.

**Ciao S R.S.I.** é uma caldeira instalada na parede tipo C que pode funcionar em vários modos:

### CASO A

apenas aquecimento, sem nenhum ebulidor externo ligado. A caldeira não fornece água quente sanitária.

### CASO B

apenas aquecimento, com um ebulidor externo ligado, gerido por um termóstato: nessa condição, a cada pedido de calor por parte do termóstato do ebulidor, a caldeira fornece água quente para a preparação da água sanitária.

### CASO C

apenas aquecimento com um ebulidor externo ligado (kit acessório a pedido), gerido por uma sonda de temperatura, para a preparação da água quente sanitária. Ao ligar um ebulidor não fornecido por nós, verificar se a sonda NTC utilizada tem as seguintes características: 10 kOhm a 25 °C, B 3435 ±1%

Na configuração B22P e B52P (quando instalada no interior), o aparelho não pode ser instalado em quartos de dormir, quartos de banho, duchas ou onde haja lareiras abertas sem afluxo de ar adequado. O local onde a caldeira será instalada deverá ter uma ventilação adequada.

Na configuração C o aparelho pode ser instalado em qualquer tipo de local e não há nenhuma limitação devida às condições de ventilação e ao volume do local.

## 3 - NORMAS PARA A INSTALAÇÃO

### 3.1 Normas para a instalação

A instalação deve ser executada por pessoal qualificado.



Além disso deve-se sempre observar as disposições nacionais e locais.

#### LOCALIZAÇÃO

**Ciao S** pode ser instalada em interiores (fig. 2).

A caldeira é dotada de protecções que lhe garantem o funcionamento correcto com um campo de temperaturas de 0°C a 60°C.

Para usufruir das protecções, o aparelho deve estar em condições de poder ser ligado, disso resulta que qualquer condição de bloqueio (por ex., falta de gás ou de alimentação eléctrica, ou intervenção de uma segurança) desactiva as protecções.

Em algumas partes do manual são utilizados os símbolos:	
	ATENÇÃO = para acções que exigem cautela especial e preparação adequada
	PROIBIDO = para acções que NÃO DEVEM absolutamente ser executadas

## DISTÂNCIAS MÍNIMAS

Para poder permitir o acesso no interior da caldeira para realizar as operações de manutenção normais, é necessário respeitar os espaços mínimos previstos para a instalação (fig. 3).

Para um posicionamento correcto do aparelho, considerar que:

- não deve ser posicionado sobre um fogão ou outro aparelho de cozimento
- é proibido deixar substâncias inflamáveis no local onde está instalada a caldeira
- as paredes sensíveis ao calor (por exemplo, aquelas em madeira) devem ser protegidas com isolamento adequado.

## IMPORTANTE

Antes da instalação, recomenda-se efectuar uma lavagem cuidadosa de todas as tubagens da instalação para remover eventuais resíduos que possam comprometer o bom funcionamento do aparelho.

Instalar abaixo da válvula de segurança um funil de recolha da água com a respectiva descarga para o caso de vazamento por sobrepressão da instalação de aquecimento. O circuito da água sanitária não necessita de válvula de segurança, mas é necessário certificar-se de que a pressão do sistema de abastecimento de água não supere os 6 bar. Em caso de dúvida será oportuno instalar um redutor de pressão. Antes do acendimento, certificar-se de que a caldeira esteja predisposta para o funcionamento com o gás disponível; isso pode ser verificado pelo texto da embalagem e pela etiqueta adesiva que indica o tipo de gás. É muito importante evidenciar que em alguns casos os canos de fumaças da caldeira ficam em pressão e, portanto, as junções dos vários elementos devem ser herméticas.

## SISTEMA ANTICONGELANTE

A caldeira é equipada de série com um sistema antigelo automático que se activa quando a temperatura da água do circuito primário desce abaixo de 6 °C. Este sistema está sempre activo, garantindo a protecção da caldeira até um nível de temperatura externa de -3 °C. Para usufruir desta protecção (baseada no funcionamento do queimador), a caldeira deve estar em condição de ser ligada; qualquer condição de bloqueio (por exemplo, falta de fornecimento de gás/electricidade ou intervenção do dispositivo de segurança) consequentemente desactiva a protecção. A protecção antigelo também pode estar activa com a caldeira em stand-by. Em normais condições de funcionamento, a caldeira é capaz de auto-protger-se do gelo. Em áreas onde as temperaturas podem cair abaixo de 0 °C, quando a máquina fica sem energia por longos períodos, recomenda-se usar um líquido anticongelante específico de boa qualidade no circuito primário, se não quiser drenar o sistema de aquecimento. Cuidadosamente siga as instruções do fabricante no que diz respeito não somente à percentagem de líquido anticongelante a ser usado para a temperatura mínima à qual deseja manter o circuito da máquina, mas também à duração e eliminação do próprio líquido. Para a parte de água quente sanitária, recomendamos que a drenagem do circuito. Os materiais com que são realizados os componentes das caldeiras são resistentes a líquidos congelantes à base de etilenoglicóis.

## 3.2 Fixação da caldeira na parede e conexões hidráulicas

Para fixar a caldeira na parede utilizar o gabarito de papelão (fig. 4-5) que se encontra na embalagem. A posição e a dimensão dos engates hidráulicos são indicados no detalhe:

<b>A</b>	retorno aquecimento	3/4"
<b>B</b>	envio aquecimento	3/4"
<b>C</b>	ligação do gás	3/4"
<b>D</b>	potência DHW	1/2" (para C.S.I.) - 3/4" (para R.S.I.)
<b>E</b>	entrada DHW	1/2" (para C.S.I.) - 3/4" (para R.S.I.)

Em caso de substituição de caldeiras Beretta de gama anterior, está disponível um kit de adaptação de conexões hidráulicas.

## 3.3 Conexão eléctrica

As caldeiras saem de fábrica completamente cabladas com o cabo de alimentação eléctrica já conectado electricamente e necessitam somente da conexão do termóstato ambiente (TA) a efectuar-se nos terminais dedicados.

Para aceder à régua de terminais:

- desligar o interruptor geral da instalação
- afrouxar os parafusos (A) de fixação do revestimento (fig. 6)
- deslocar para a frente e depois para cima a base do revestimento para desengatá-lo da estrutura
- afrouxar o parafuso de fixação (B) do quadro de instrumentos (fig. 7)
- girar o quadro de instrumentos em sua direcção
- remover a cobertura da régua de terminais (fig. 8)
- introduzir o cabo do eventual T.A. (fig. 9)

O termóstato ambiente deve ser conectado como indicado no esquema eléctrico.

 **Entrada termóstato ambiente em baixa tensão de segurança (24 Vdc).**

A conexão à rede eléctrica deve ser realizada por meio de um dispositivo de separação com abertura omnipolar de pelo menos 3,5 mm (EN 60335-1, categoria III).

O aparelho funciona com corrente alternada de 230 V/50 Hz, e uma potência eléctrica de 100 W para 20 C.S.I. - 115 W para 24 C.S.I. e 24 R.S.I. E (e está em conformidade com a norma EN 60335-1).

 É obrigatória a conexão com uma eficaz instalação de tomada de terra, segundo as normas nacionais e locais vigentes.

 É recomendado respeitar a conexão de fase neutra (L-N).

 O condutor de terra deve ser cerca de dois centímetros mais comprido que os outros.

 **É proibido o uso de tubos de gás e/ou água como tomada de terra de aparelhos eléctricos.**

O fabricante não pode ser considerado responsável por eventuais danos causados pela falta de tomada de terra da instalação.

Para a ligação eléctrica utilizar o **cabo de alimentação em dotação**.

**No caso de substituição do cabo de alimentação, utilizar um cabo do tipo HAR H05V2V2-F, 3 x 0,75 mm<sup>2</sup>, diâmetro máx. externo 7 mm.**

## 3.4 Conexão do gás

Antes de efectuar a conexão do aparelho à rede do gás, certificar-se que:

- tenham sido respeitadas as normas nacionais e locais de instalação
- o tipo de gás seja aquele para o qual o aparelho foi predisposto
- as tubagens estejam limpas.

A canalização do gás é prevista externa. No caso em que o tubo atravesse a parede, este deve passar através do furo central da parte inferior do gabarito.

Recomenda-se instalar na linha do gás um filtro de dimensões adequadas no caso em que a rede de distribuição contenha partículas sólidas. Com a instalação realizada, verificar que as junções executadas tenham estanquidade como previsto pelas normas vigentes sobre instalação

## 3.5 Evacuação dos produtos da combustão e aspiração do ar

Para a evacuação dos produtos combustíveis, consultar as normas locais e nacionais vigentes. Além disso deve-se observar as normas locais dos Bombeiros, da Companhia de Gás e as eventuais disposições municipais.

A evacuação dos produtos combustíveis é assegurada por um ventilador centrífugo colocado dentro da câmara de combustão e o seu correcto funcionamento é constantemente controlado por um pressostato. A caldeira é fornecida sem o kit de descarga de fumos/aspiração do ar, pelo facto de que é possível utilizar os acessórios para aparelhos de câmara estanque de tiragem forçada que se adaptam melhor às características tipológicas de instalação.

É indispensável para a extracção dos fumos e o restabelecimento do ar comburente da caldeira que sejam utilizadas tubagens certificadas e que a conexão ocorra de maneira correcta conforme indicado nas instruções fornecidas com os acessórios de fumos.

A um só tubo de evacuação de fumo podem ser conectados mais aparelhos desde que todos sejam do tipo de câmara estanque.

## INSTALAÇÃO "FORCED OPEN" (TIPO B22P/B52P)

### Conduta de descarga dos fumos Ø 80 mm (fig. 10a)

A conduta de descarga dos fumos pode ser orientada para a direcção mais adequada às exigências da instalação. Para a instalação siga as instruções entregues com o kit.

 Nesta configuração a está conectada à conduta de descarga dos fumos Ø 80 mm através de um adaptador Ø 60-80 mm. Neste caso o ar comburente é tirado do local de instalação da caldeira, que deve ser um local técnico adequado e provido de arejamento.

 As condutas de descarga dos fumos não isoladas, são potenciais fontes de perigo.

A flange de fumos (F), quando necessário, deve ser tirada fazendo alavanca com uma chave de fenda.

A caldeira adapta automaticamente a ventilação segundo o tipo de instalação e o comprimento da conduta.

## 20 C.S.I.

Comprimento dos tubos Ø 80 [m]	Flange de gases da chaminé (F)	Perdas de carga de cada curva (m)	
		45°	90°
até 1,5	Ø 39	1,2	1,7
de 1,5 a 5	Ø 41 (**)		
de 5 a 14	Ø 43		

(\*\*) montada na caldeira

24 C.S.I. - 24 R.S.I.

Comprimento dos tubos Ø 80 [m]	Flange de gases da chaminé (F)	Perdas de carga de cada curva (m)	
		45°	90°
até 2	Ø 42	1,2	1,7
de 2 a 8	Ø 44 (**)		
de 8 a 25	não instalada		

(\*\*) montada na caldeira

DESCARGAS COAXIAIS (Ø 60-100)

A caldeira foi projectada para ser conectada a tubos de descarga/ aspiração concêntricos e com a abertura para a aspiração do ar (E) fechada (fig. 10b). As descargas concêntricas podem ser orientadas na direcção mais adequada às exigências do local, respeitando os comprimentos máximos indicados na tabela. Para a instalação, seguir as instruções fornecidas com o kit.

Segundo o comprimento dos tubos utilizado, é necessário inserir uma flange escolhendo-a entre aquelas contidas na caldeira (consultar tabelas indicadas a seguir). A flange de gases da chaminé (F), quando necessário, deve ser tirada fazendo alavanca com uma chave de fenda. A tabela indica os comprimentos rectilíneos admitidos. Segundo o comprimento dos tubos utilizado, é necessário inserir uma flange escolhendo-a entre aquelas contidas na caldeira (consultar tabelas indicadas a seguir).

20 C.S.I.

Comprimento dos tubos [m]	Flange de gases da chaminé (F)	Perdas de carga de cada curva (m)	
		45°	90°
até 0,85	Ø 39	1	1,5
de 0,85 a 2,35	Ø 41 (**)		
de 2,35 a 4,25	Ø 43		

(\*\*) montada na caldeira

24 C.S.I. - 24 R.S.I.

Comprimento dos tubos [m]	Flange de gases da chaminé (F)	Perdas de carga de cada curva (m)	
		45°	90°
até 0,85	Ø 42	1	1,5
de 0,85 a 2,35	Ø 44 (**)		
de 2,35 a 4,25	não instalada		

(\*\*) montada na caldeira

Tubos concêntricos (Ø 80/125)

A caldeira é fornecida predisposta para ser conectada a tubos de descarga/aspiração coaxiais e com a abertura para a aspiração do ar fechada. As descargas concêntricas podem ser orientadas na direcção mais adequada às exigências do local, respeitando os comprimentos máximos indicados na tabela.

Para a instalação, seguir as instruções fornecidas com o kit. Para o atravessamento da parede fazer um furo de Ø 140 mm. De acordo com o comprimento dos tubos utilizado, é necessário inserir uma flange escolhendo-a entre aquelas contidas na caldeira (**consultar tabela**). Prestar atenção especial à temperatura externa e ao comprimento do tubo. Consultar os gráficos para estabelecer a obrigatoriedade ou não da utilização do recolhedor de condensação. Em caso de funcionamento a temperaturas de caldeira inferiores a 60 °C, é obrigatória a utilização do recolhedor de condensação. Em caso de utilização do recolhedor de condensação prever uma inclinação do tubo de descarga de fumos de 1% em direcção ao próprio recolhedor. Conectar o sifão do recolhedor de condensação a uma descarga das águas brancas.

Os tubos de descarga não isolados são potenciais fontes de perigo.

20 C.S.I.

Comprimento dos tubos Ø 80 125 [m]	Flange de gases da chaminé (F)	Perdas de carga de cada curva (m)	
		45°	90°
de 0,96 a 3,85	Ø 39	1,35	2,2
de 3,85 a 7,85	Ø 41 (**)		
de 7,85 a 12,40	Ø 43		

(\*\*) montada na caldeira

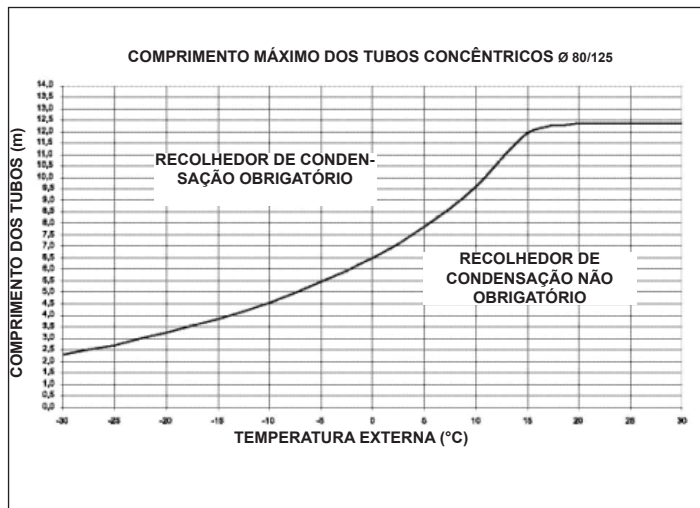

**kit curva coaxial rebaixada**

⚠ Se for necessário instalar o Ciao S em instalações já existentes (substituição de gama Ciao N/Mynute), está disponível o "kit curva concêntrica reduzida" que permite posicionar a caldeira conservando o mesmo furo de saída dos gases da chaminé.

Comprimento dos tubos com curva rebaixada [m]	Flange de gases da chaminé (F)		Perdas de carga de cada curva (m)	
	Ciao S 20 C.S.I.	Ciao S 24 C.S.I.	45°	90°
até 1,85	Ø 41	Ø 44	1	1,5
de 1,85 a 4,25	Ø 43	nenhuma flange		

24 C.S.I. - 24 R.S.I.

Comprimento dos tubos Ø 80 125 [m]	Flange de gases da chaminé (F)	Perdas de carga de cada curva (m)	
		45°	90°
de 0,96 a 3,85	Ø 42	1,35	2,2
de 3,85 a 7,85	Ø 44 (**)		
de 7,85 a 12,4	não instalada		

(\*\*) montada na caldeira

**DESCARGAS DIVIDIDAS (ø 80) (fig. 11)**

As descargas divididas podem ser orientadas na direcção mais adequada às exigências do local.

Para utilizar um tubo de sucção de ar comburente, uma das duas entradas (G e H) deve ser seleccionada. Remova a ficha de fechamento que é fixada usando parafusos, e use o adaptador específico relacionado à entrada seleccionada.

⚠ O adaptador de entrada de ar ø 80 (X) deve ser orientado correctamente, e conseqüentemente é necessário fixá-lo usando os parafusos apropriados, de forma que a aba de localização não interfira com a cobertura: adaptador de entrada de ar X ø 80 - adaptador de entrada de ar Y de ø 60 a ø 80.

A flange de gases da chaminé (F), quando necessário, deve ser tirada fazendo alavanca com uma chave de fenda. A tabela indica os comprimentos rectilíneos admitidos. Segundo o comprimento dos tubos utilizado, é necessário inserir uma flange escolhendo-a entre aquelas contidas na caldeira (consultar tabelas indicadas a seguir).

**20 C.S.I.**

Comprimento dos tubos [m]	Flange de gases da chaminé (F)	Perdas de carga de cada curva (m)	
		45°	90°
1+1	Ø 39	1.2	1.7
>1+1 ÷ 4+4	Ø 41 (**)		
>4+4 ÷ 10+10	Ø 43		

(\*\*) montada na caldeira

**24 C.S.I. - 24 R.S.I.**

Comprimento dos tubos [m]	Flange de gases da chaminé (F)	Perdas de carga de cada curva (m)	
		45°	90°
2+2	Ø 42	1,2	1,7
> 2+2 ÷ 6+6	Ø 44 (**)		
> 6+6 ÷ 16+16	não instalada		

(\*\*) montada na caldeira

**B22P/B52P** Aspiração interna e descarga externa

**C12-C12x** Descarga via saída de parede concêntrica. Os tubos podem deixar a caldeira independentemente, mas as saídas devem ser concêntricas ou próximas o suficiente para estar sujeitas a condições similares de vento (dentro de 50 cm)

**C22** Descarga via saída concêntrica em tubo de fumo comum (sucção e descarga no mesmo tubo)

**C32-C32x** Descarga via saída concêntrica da cobertura. Saídas quanto a C13

**C42-C42x** Descarga e aspiração em tubos de fumos comuns separados, mas submetidos a condições de vento semelhantes

**C52-C52x** Tubos de aspiração e descarga separados na parede ou no tecto e em zonas com pressões diferentes. Os tubos de aspiração e de descarga nunca devem ser posicionados em paredes opostas

**C62-C62x** Tubos de descarga e aspiração usando tubos vendidos e certificados separadamente (1856/1)

**C82-C82x** Descarga através de tubo de fumos único ou comum e aspiração de parede

**C92-C92x** Descarga no tecto (similar ao C33) e aspiração de ar de um único tubo de fumos existente

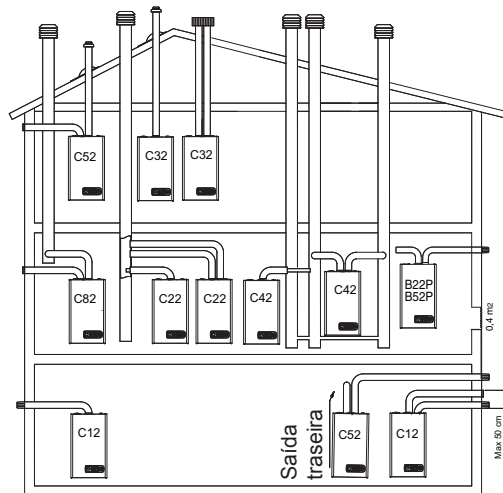

**3.6 Enchimento do sistema de aquecimento (fig. 13)**

Efectuadas as conexões hidráulicas, pode-se proceder ao enchimento da instalação de aquecimento. Esta operação deve ser executada com a instalação fria efectuando as seguintes operações:

- abrir com duas ou três voltas a tampa da válvula de alívio automática (I)
- certificar-se de que a torneira de entrada de água fria esteja aberta
- abrir a tampa de enchimento (L fig. 13 para C.S.I. - externo para R.S.I.) até que a pressão indicada pelo manómetro esteja entre 1 e 1,5 bar.

Com o enchimento efectuado, fechar a válvula de enchimento.

A caldeira é dotada de um eficiente separador de ar, portanto, não é exigida nenhuma operação manual. O queimador se acende somente se a fase de desgasificação estiver concluída.

**3.7 Esvaziamento da instalação de aquecimento**

Para esvaziar a instalação, proceder no modo seguinte:

- desligar a caldeira
- aliviar a torneira de descarga da caldeira (M)
- esvaziar os pontos mais baixos da instalação.

**3.8 Esvaziando a água quente sanitária (apenas para o modelo C.S.I.)**

Sempre que exista risco de gelo, a instalação sanitária deve ser esvaziada procedendo no seguinte modo:

- fechar a torneira geral da rede hídrica
- abrir todas as torneiras da água quente e fria
- esvaziar os pontos mais baixos.

**ATENÇÃO**

Quando realizar a descarga da válvula de segurança (N), ela deve ser conectada a um adequado sistema de recolha. O fabricante do aparelho não pode ser considerado responsável por eventuais alagamentos causados pela intervenção da válvula de segurança.

## 4 ACENDIMENTO E FUNCIONAMENTO

### 4.1 Verificações preliminares

O primeiro acendimento deve ser feito por pessoal competente de um Centro de Assistência Técnica autorizado Beretta.

Antes de ligar a caldeira, é preciso verificar:

- que os dados das redes de alimentação (eléctrica, hídrica, gás) correspondam àqueles da placa
- que as tubagens que se ramificam da caldeira estejam cobertas por uma capa termoisolante
- que os tubos de evacuação dos fumos e aspiração do ar estejam eficientes
- que sejam garantidas as condições para as manutenções normais no caso em que a caldeira seja colocada dentro ou entre os móveis
- a estanquidade da instalação de adução do combustível
- que o caudal do combustível corresponda aos valores exigidos para a caldeira
- que a instalação de alimentação do combustível seja dimensionado para o caudal necessário à caldeira e que seja dotado de todos os dispositivos de segurança e controlo prescritos pelas normas vigentes.

### 4.2 Acendimento do aparelho



Para o acendimento da caldeira é necessário efectuar as seguintes operações:

- alimentar electricamente a caldeira
- abrir a válvula do gás presente na instalação para permitir o fluxo do combustível
- girar o selector de modo (1 - fig. 1a) para a posição desejada:

#### Ciao S C.S.I.:

**Modo verão:** girando o selector para o símbolo verão  (fig. 2a) activa-se a função tradicional de somente água quente sanitária. Se houver uma solicitação de água quente sanitária, o mostrador digital mostra a temperatura do sistema de água quente, o ícone para indicar o suprimento de água quente e o ícone de chama

**Inverno:** girando o selector de função dentro da zona marcada + e - (fig. 2b), a caldeira fornece água quente sanitária e aquecimento. Se houver um pedido de calor, a caldeira liga e o monitor digital indica a temperatura da água em aquecimento, o ícone para indicar o aquecimento e o ícone de chama (fig. 3a). Se houver uma solicitação de água quente sanitária, a caldeira liga e o mostrador digital mostra a temperatura do sistema de água quente, o ícone para indicar o suprimento de água quente e o ícone de chama (fig. 4a)

**Pré-aquecimento** (água quente mais rápido): gire o manípulo de regulação de temperatura de água quente sanitária (2 - fig. 1a) para o símbolo  (fig. 5a) para activar a função de pré-aquecimento. Esta função permite manter aquecida a água contida no intercambiador sanitário para reduzir os tempos de espera durante o fornecimento. Quando a função de pré-aquecimento está habilitada, o monitor indica a temperatura do caudal da água em aquecimento ou da água quente sanitária, com base na solicitação em curso. Durante o acendimento do queimador, após uma solicitação de pré-aquecimento, o monitor mostra o símbolo **P** (fig. 5b). Para desactivar a função pré-aquecimento, gire novamente o manípulo de regulação da temperatura da água quente sanitária para o símbolo . Colocar o manípulo de regulação da temperatura da água sanitária na posição desejada. A função não está activa com a caldeira no estado OFF: selector de função (1 fig. 1a) em  OFF.

#### Ciao S R.S.I.:

**Modo verão (apenas com o reservatório de água externa conectado):** girando o selector para o símbolo verão  (fig. 2a), é activada a função tradicional de somente água quente sanitária e a caldeira fornece água à temperatura definida no reservatório de armazenamento externo. Se houver uma solicitação de água quente sanitária, o mostrador digital mostra a temperatura do sistema de água quente, o ícone para indicar o suprimento de água quente e o ícone de chama

**Inverno:** girando o selector de função dentro da zona marcada + e - (fig. 2b), a caldeira fornece água quente para aquecimento e - se conectada a um reservatório de armazenamento externo - água quente sanitária. Se houver um pedido de calor, a caldeira liga e o monitor digital indica a temperatura da água em aquecimento, o ícone para indicar o aquecimento e o ícone de chama (fig. 3a). Se houver uma solicitação de água quente sanitária, a caldeira liga e a tela digital mostra a temperatura do sistema de água quente, o ícone para indicar o suprimento de água quente e o ícone de chama (fig. 4a).

Regular o termostato ambiente na temperatura desejada (~20°C)

#### Ciao S C.S.I.: Regulação da temperatura da água quente sanitária

Para regular a temperatura da água sanitária (banheiros, duchas, cozinha, etc.), gire o manípulo com o símbolo  (fig. 2b) dentro da área marcada + e -.

A caldeira está em status de espera até que, depois de um pedido de calor, o queimador liga e o mostrador digital mostra a temperatura do sistema de água quente, o ícone para indicar o suprimento de água quente e o ícone de chama.

A caldeira ficará em função até que sejam alcançadas as temperaturas reguladas, depois disso colocar-se-á novamente em estado de "stand-by".

Se a luz indicadora vermelha próxima ao símbolo  no painel de comando acender, isto significa que a caldeira está em status de paragem temporária (consulte o capítulo sobre sinais de luz e anomalias). O display digital mostra o código da anomalia encontrado (fig. 6a).

#### Ciao S R.S.I.: Regulação da temperatura da água sanitária

**CASO A** apenas aquecimento - regulação não aplicável

**CASO B** apenas aquecimento + ebulidor externo com termostato - regulação não aplicável.

**CASO C** apenas aquecimento + reservatório de armazenamento externo com sonda - para ajustar a temperatura da água quente sanitária no reservatório de armazenamento, gire o manípulo com o símbolo em sentido horário para aumentar a temperatura da água e anti-horário para diminuí-la.

A caldeira está em status de espera até que, depois de um pedido de calor, o queimador liga e o mostrador digital mostra a temperatura do sistema de água quente, o ícone para indicar o suprimento de água quente e o ícone de chama.

A caldeira ficará em função até que sejam alcançadas as temperaturas reguladas, depois disso colocar-se-á novamente em estado de "stand-by".

Se a luz indicadora vermelha próxima ao símbolo  no painel de comando acender, isto significa que a caldeira está em status de paragem temporária (consulte o capítulo sobre sinais de luz e anomalias). O mostrador digital mostra o código da avaria detectado (fig. 6a)

#### Ciao S C.S.I. - Ciao S R.S.I.: Função Sistema Automático Regulação Ambiente (S.A.R.A.) fig. 7a

Posicionando o selector da temperatura da água do aquecimento na zona assinalada pela escrita AUTO - valor de temperatura de 55 a 65°C-, activa-se o sistema de auto-regulação S.A.R.A.: a caldeira varia a temperatura de envio em função do sinal de fechamento do termostato ambiente. Ao alcançar a temperatura configurada com o selector de temperatura da água do aquecimento, inicia uma contagem de 20 minutos. Se durante este período o termostato ambiente continua a exigir calor, o valor da temperatura configurada aumenta automaticamente em 5 °C.

Ao alcançar o novo valor configurado começa uma contagem de outros 20 minutos.

Se durante este período o termostato ambiente continua a exigir calor, o valor da temperatura configurada aumenta automaticamente em outros 5 °C.

Este novo valor de temperatura é o resultado da temperatura configurada manualmente com o selector de temperatura da água de aquecimento e o aumento de +10 °C da função S.A.R.A.



Depois do segundo ciclo, o valor de temperatura deve ser mantido no valor configurado de +10 °C até que a solicitação de termostato ambiente seja satisfeita.

### 4.3 Desligamento

#### Desligamento temporário

No caso de ausência por curtos períodos de tempo, configure o selector de modo (1 - fig. 1a) para  (OFF).

Deste modo, deixando activadas a alimentação eléctrica e a alimentação do combustível, a caldeira é protegida por sistemas:

- **Dispositivo antigelo:** quando a temperatura da água da caldeira cai abaixo de 5°C activa-se o circulador e, se necessário, o queimador na potência mínima para levar a temperatura da água a valores de segurança (35°C). Durante o ciclo anticongelamento, no monitor digital aparece o símbolo .
- **Função antibloqueio do circulador:** um ciclo de funcionamento é activado a cada 24 horas.
- **Anticongelamento DHW (apenas quando conectado a um reservatório de armazenamento externo com sonda):** a função activa-se se a temperatura detectada pela sonda do ebulidor descer abaixo de 5°C. Nessa fase é gerado um pedido de calor com acendimento do queimador à mínima potência, que é mantida até a temperatura da água de descarga alcança 55°C. Durante o ciclo anticongelamento, no monitor digital aparece o símbolo .



















**Desligamento por longos períodos**

Em caso de ausências prolongadas, posicione o selector de modo (1 - fig. 1a) em  (OFF).



Fechar então a válvula do gás presente na instalação. Neste caso a função antigelo é desactivada: esvaziar as instalações se houver risco de gelo.

**4.4 Sinalizações luminosas e anomalias**

O status de operação da caldeira é mostrado no monitor digital, abaixo está uma lista dos tipos de monitores.

STATUS DA CALDEIRA	MONITOR
Em espera	-
Status OFF	OFF
Alarme de bloqueio do módulo ACF	A01 
Alarme de avaria eléctrica ACF	A01 
Alarme de termóstato de limite	A02 
Alarme de pressostato de ar	A03 
Alarme de pressostato H2O	A04 
Avaria de água sanitária NTC (C.S.I. e R.S.I. apenas com aquecedor de armazenamento externo com sonda)	A06 
Avaria de aquecimento NTC	A07 
Chama parasita	A11 
Calibragem eléctrica aquecimento min e max	ADJ 
Ignição transiente de espera	88 °C intermitente
Intervenção do pressostato de ar	 intermitente
Intervenção do pressostato de H2O	 intermitente
Função de pré-aquecimento activa (apenas C.S.I.)	P
Pedido de calor de pré-aquecimento (apenas C.S.I.)	P intermitente
Sonda externa presente	
Pedido de calor de água sanitária	60 °C 
Pedido de calor de aquecimento	80 °C 
Pedido de calor anticongelamento	
Presença de chama	

**Para restabelecer o funcionamento (desbloqueio de alarmes): Anomalias A 01-02-03**



Posicione o selector de função em  desligado (OFF), espere 5-6 segundos e coloque-o na posição desejada  (verão) ou  (inverno). Se as tentativas de desbloqueio não reactivam a caldeira, solicitar a intervenção do Serviço Técnico de Assistência.

**Anomalia A 04**

O display digital exhibe, além do código da anomalia, o símbolo .

Verificar o valor de pressão indicado pelo hidrómetro:

Se for menor que 0,3 bar, posicione o selector de função em  (OFF) e ajuste a torneira de enchimento (L fig. 13 para C.S.I. - externo para R.S.I.) até que a pressão alcance um valor entre 1 e 1,5 bar.

Então gire o selector de modo para a posição desejada  (verão) ou  (inverno).

A caldeira executará um ciclo de ventilação com duração de aproximadamente 2 minutos.

Se as quedas de pressão são frequentes, solicitar a intervenção do Serviço Técnico de Assistência.

**Avaria A 06 (apenas C.S.I.)**

A caldeira funciona normalmente, mas não garante a estabilidade da temperatura da água quente sanitária, que permanece programada em torno de 50 °C. Entre em contacto com o Centro de Assistência Técnica.

**Anomalia A 07**

Solicitar a intervenção do Serviço Técnico de Assistência.

**4.5 Regulações**

A caldeira já foi regulada em fase de fabricação pelo fabricante.

Se for necessário todavia efectuar novamente as regulações, por exemplo, depois de uma manutenção extraordinária, depois da substituição da válvula do gás ou depois de uma transformação do gás, observar os procedimentos descritos a seguir.

 **As regulações da potência máxima devem ser executadas na sequência indicada e exclusivamente por pessoal qualificado.**

- remova o revestimento afrouxando os parafusos de fixação A (fig. 6)
- afrouxar cerca de duas voltas o parafuso da tomada de pressão a jusante da válvula do gás e conectar o manómetro
- desconectar a tomada de compensação da caixa de ar

**4.5.1 Ciao S C.S.I.: Regulação da água quente sanitária mínima e energia máxima**

- Abra completamente a torneira da água quente
- no painel de comando:
- coloque o selector de função em  (verão) (fig. 2a)
- coloque no valor máximo o selector de temperatura da água quente sanitária (fig. 8a)
- alimentar electricamente a caldeira posicionando o interruptor geral da instalação em "aceso"
- verificar que a pressão lida no manómetro seja estável; ou com o auxílio de um miliamperímetro em série no modulador, certificar-se de que no modulador seja distribuída a máxima corrente disponível (120 mA para G20 e 165 mA para GPL).
- cuidadosamente tire a tampa de protecção dos parafusos de regulação, usando uma chave de fendas (fig. 15)
- com uma chave de boca CH10, actue na porca de regulação da potência máxima para obter o valor indicado na tabela "Dados técnicos"
- desconectar um faston do modulador
- esperar que a pressão lida no manómetro se estabilize no valor mínimo
- com uma chave Allen, prestando atenção para não pressionar o eixo interno, actue no parafuso vermelho de regulação para uma regulação de temperatura mínima da água quente sanitária, e calibre até ler no manómetro o valor indicado na tabela "Dados técnicos"
- conectar novamente o faston do modulador
- fechar a torneira da água quente sanitária
- recolocar com cuidado a tampa de protecção dos parafusos de regulação.

**Ciao S R.S.I.: Regulação de energia máxima e mínima**

- Configure o selector de função para  (inverno) (fig. 2b)
- Remova o revestimento e acesse o cartão
- Insira os jumpers JP1 e JP2
- Traga o aparador P2 para o valor máximo, usando uma chave de fendas (girar no sentido horário)
- Alimente a caldeira posicionando o interruptor geral do sistema em "on"
- Verifique se a pressão está estável no manómetro; ou, com um miliamperímetro em série com o modulador, certifique-se de que o modulador distribua a máxima corrente disponível (120 mA para G20 e 165 mA para GPL)
- Use uma chave de fendas para tirar cuidadosamente a tampa de protecção dos parafusos de regulação
- Com uma chave de boca CH10, use a porca de regulação da potência máxima para obter o valor indicado na tabela "Dados técnicos"
- Desconecte o faston do modulador
- Espere até que a pressão no manómetro esteja estável a um valor mínimo
- Use uma chave Allen para ajustar o parafuso de regulação vermelho na potência mínima, fazendo a calibragem até que o manómetro mostre o valor indicado na tabela "Dados técnicos"
- Conecte novamente o faston do modulador
- Desconecte a caldeira da alimentação
- Remova os jumpers JP1 e JP2
- Recoloque cuidadosamente a tampa de protecção dos parafusos de regulação.

**4.5.2 Regulação eléctrica mínimo e máximo aquecimento**

 A função "regulação eléctrica" é activada e desactivada exclusivamente pelo jumper (JP1) (fig. 16).

ADJ  aparece no monitor para indicar que o procedimento de calibragem está em andamento.

A habilitação da função pode ser efectuada nos seguintes modos:

- alimentando a placa com o jumper JP1 inserido e o selector de função em posição inverno, independentemente da eventual presença de outras solicitações de funcionamento.
- inserindo o jumper JP1, com o selector de função em estado inverno, sem solicitação de calor em curso.

⚠ A activação da função prevê o acendimento do queimador por meio da simulação de uma solicitação de calor em aquecimento.

Para efectuar as operações de calibragem, agir como a seguir:

- desligar a caldeira
- remover o revestimento e aceder à placa
- introduza o jumper JP1 (fig. 16) para habilitar os manípulos colocados no painel de comando às funções de regulações do mínimo e do máximo aquecimento.
- certificar-se de que o selector de função esteja na posição inverno (consultar parágrafo 4.2).
- alimentar electricamente a caldeira

⚠ **Placa eléctrica em tensão (230 Volt)**

- gire o manípulo de regulação da temperatura da água de aquecimento **B** (fig. 17) até alcançar o valor de mínimo aquecimento como indicado na tabela multigás
- introduza o jumper JP2 (fig. 16)
- gire o manípulo de regulação da temperatura da água quente sanitária **C** (fig. 17) até alcançar o valor de máximo aquecimento como indicado na tabela multigás
- remover o jumper JP2 para memorizar o valor de aquecimento máximo
- **remover o jumper JP1 para memorizar o valor de aquecimento mínimo e para sair do procedimento de calibragem**
- conectar novamente a tomada de compensação à caixa de ar

Desconecte o manómetro e volte a apertar o parafuso da tomada de pressão.

⚠ Para terminar a função de calibragem sem a memorização dos valores configurados, opere do seguinte modo:

- a) colocar o selector de função na posição  (OFF)
- b) tire a tensão de alimentação
- c) remova JP1/JP2

⚠ A função de calibragem é automaticamente concluída, sem a memorização dos valores mínimo e máximo, transcorridos 15 minutos da sua activação.

⚠ A função é automaticamente concluída também em caso de paragem ou bloqueio definitivo. Também neste caso a conclusão da função NÃO prevê a memorização dos valores.

**Nota:**

Para executar a calibragem somente do máximo aquecimento, é possível remover o jumper JP2 (para memorizar o máximo) e sucessivamente sair da função, sem memorizar o mínimo, colocando o selector de função em  (OFF) ou tirando tensão da caldeira.

⚠ Após cada intervenção no elemento de regulação da válvula de gás, selá-lo com verniz de selagem.

Com as regulações terminadas:

- colocar a temperatura configurada com o termóstato ambiente naquela desejada
- colocar o selector de temperatura da água de aquecimento na posição desejada
- fechar o quadro de instrumentos
- reposicione o revestimento.

**4.6 Transformação gás**

A transformação de um gás de uma família a um gás de uma outra família pode ser feita facilmente mesmo com a caldeira instalada.

A caldeira é fornecida para o funcionamento a gás metano (G20) segundo o indicado pela placa do produto.

Existe a possibilidade de transformar as caldeiras de um tipo de gás a outro utilizando os específicos kits fornecidos a pedido:

- Kit de transformação Metano
- Kit de transformação GPL

Para a desmontagem consultar as instruções indicadas a seguir:

- tirar a alimentação eléctrica da caldeira e fechar a válvula do gás
- remover sucessivamente: revestimento, tampa da caixa de distribuição do ar e tampa da câmara de combustão (fig. 19)
- desconectar a conexão do cabo da vela
- retirar o passacabo inferior da sede da caixa de ar
- tirar os parafusos de fixação do queimador e remover este último com a vela ligada e os relativos cabos
- utilizando uma chave de caixa ou de boca, remova as boquilhas e as anilhas e substitua-as pelas que se encontram no kit.

⚠ **Utilizar e montar taxativamente as anilhas contidas no kit também em caso de colectores sem anilhas.**

- recolocar o queimador na câmara de combustão e apertar os parafusos que o fixam ao colectore de gás
- posicionar o passacabo com o cabo da vela na sua sede na caixa do ar
- restabelecer a conexão do cabo da vela
- remontar a tampa da câmara de combustão e a tampa da caixa de ar
- reclinar o quadro de instrumentos dos comandos em direcção à frente da caldeira
- abrir a tampa da placa
- na placa de controlo (fig. 16):
  - se a conversão for de gás metano para GPL, insira o jumper na posição JP3
  - caso se trate de transformação de GPL em gás metano, tirar a interconexão da posição JP3
- reposicionar os componentes removidos precedentemente
- dar novamente tensão à caldeira e abrir a válvula do gás (com a caldeira em função verificar a correcta estanquidade das junções do circuito de alimentação do gás).

⚠ **A transformação deve ser executada somente por pessoal qualificado.**

⚠ **Executada a transformação, regular novamente a caldeira seguindo o indicado no parágrafo específico e aplicar a nova placa de identificação contida no kit.**

**5 MANUTENÇÃO**

Para garantir a permanência das características e eficiência do produto e para respeitar as prescrições da legislação vigente, é necessário submeter o aparelho a controlos sistemáticos em intervalos regulares. A frequência dos controlos depende das particulares condições de instalação e de uso, mas é de todo modo oportuno um controle anual por parte de pessoal autorizado dos Centros de Assistência Técnica. Desligue o aparelho para fazer a manutenção da estrutura próxima às conexões de exaustão da chaminé ou dispositivos, e seus acessórios. Uma vez que as intervenções estiverem terminadas, um técnico qualificado deve verificar se todos os tubos e dispositivos funcionam correctamente.

**IMPORTANTE:** antes de iniciar qualquer operação de limpeza ou manutenção do aparelho, agir no interruptor do próprio aparelho e da instalação para interromper a alimentação eléctrica e fechar a alimentação do gás agindo na válvula situada na caldeira.

Não efectuar limpezas do aparelho nem de suas partes com substâncias facilmente inflamáveis (p. ex., gasolina, álcool, etc.).

Não limpar os painéis, as partes pintadas e partes em plástico com diluentes para tintas.

A limpeza dos painéis deve ser feita somente com água e sabão.

**5.1 Verificação dos parâmetros de combustão**

**Ciao S C.S.I.:**

Para efectuar a análise da combustão executar as seguintes operações:

- abrir uma torneira da água quente na vazão máxima
- coloque o selector de modo em verão  e o selector de temperatura da água quente sanitária no valor máximo (fig. 8a).
- remova o parafuso da tampa da entrada de análise da combustão (fig. 18) e introduza as sondas
- alimentar electricamente a caldeira

**Ciao S R.S.I.:**

- desligue a caldeira
- configure o selector de função para o modo inverno
- remova o revestimento e acesse o cartão
- insira os jumpers JP1 e JP2
- use uma chave de fendas para abrir a ficha do painel de comando
- traga o aparador P2 para o valor máximo, usando uma chave de fendas (gire em sentido horário)
- remova o parafuso da tampa da entrada de análise da combustão (fig. 18) e introduza as sondas
- alimente a caldeira

O aparelho funciona na potência máxima e é possível efectuar o controlo da combustão.

Com a análise completada:

- fechar a torneira da água quente
- remover a sonda do analisador e fechar a tomada de análise de combustão fixando com cuidado o parafuso removido anteriormente.

## UTILIZADOR

### 1A ADVERTÊNCIAS GERAIS E SEGURANÇAS

O manual de instruções constitui parte integrante do produto e consequentemente deve ser conservado com cuidado e acompanhar sempre o aparelho; em caso de extravio ou dano, solicitar uma outra cópia ao Centro de Assistência Técnica.

- ⚠ A instalação da caldeira e qualquer outra intervenção de assistência e de manutenção deve ser realizada por pessoal qualificado de acordo com as indicações das normas locais e nacionais vigentes.
- ⚠ Para a instalação recomenda-se de dirigir-se a pessoal especializado.
- ⚠ O aparelho deve ser usado apenas para a aplicação prevista pela empresa fabricante. O fabricante não será responsável por quaisquer danos a pessoas, animais ou bens devido a erros de instalação, manutenção, calibração ou devido ao uso inadequado.
- ⚠ Os dispositivos de segurança ou de regulação automática dos aparelhos não devem, durante toda a vida da instalação, ser modificados a não ser pelo fabricante ou pelo fornecedor.
- ⚠ Este aparelho serve para produzir água quente, deve portanto ser ligado a uma instalação de aquecimento e/ou a uma rede de distribuição de água quente sanitária, compativelmente com as suas prestações e com a sua potência.
- ⚠ Em caso de vazamentos de água, fechar a alimentação hídrica e avisar com presteza o pessoal qualificado do Centro de Assistência Técnica.
- ⚠ Em caso de ausência prolongada, fechar a alimentação do gás e desligar o interruptor geral de alimentação eléctrica. No caso em que se preveja risco de gelo, retirar toda a água da caldeira.
- ⚠ Verificar de vez em quando que a pressão de exercício da instalação hidráulica não tenha descido abaixo do valor de 1 bar.
- ⚠ Em caso de avaria e/ou de mau funcionamento do aparelho, desactive-o sem qualquer tentativa de reparação ou de intervenção directa.
- ⚠ A manutenção do aparelho deve ser executada pelo menos uma vez ao ano: programá-la antecipadamente com o Centro de Assistência Técnica significará evitar desperdícios de tempo e dinheiro.

A utilização da caldeira exige a rigorosa observação de algumas regras fundamentais de segurança:

- Não utilizar o aparelho para fins diferentes daqueles a que é destinado.
- É perigoso tocar o aparelho com partes do corpo molhadas ou húmidas e/ou com os pés descalços.
- É absolutamente desaconselhado tapar com panos, papéis ou outro objecto as grades de aspiração ou de dissipação e a abertura de ventilação do local onde o aparelho é instalado.
- Se houver cheiro de gás, não accione de maneira nenhuma interruptores eléctricos, telefone e qualquer outro objecto que possa provocar centelhas. Arejar o local abrindo portas e janelas e fechar a válvula central do gás.
- Não apoie objectos sobre a caldeira.
- é desaconselhada qualquer operação de limpeza antes de ter desligado o aparelho da rede de alimentação eléctrica.
- Não tapar ou reduzir a dimensão das aberturas de ventilação do local onde está instalado o gerador.
- Não deixar contentores e substâncias inflamáveis no local onde o aparelho está instalado.
- É desaconselhada qualquer tentativa de reparação em caso de avaria e/ou de mau funcionamento do aparelho.
- É perigoso puxar ou torcer os cabos eléctricos.
- É desaconselhado o uso do aparelho por parte de crianças ou de pessoas inexperientes.
- É proibido intervir nos elementos lacrados.

Para uma melhor utilização, lembrar-se de que:

- uma limpeza externa periódica com água e sabão, além de melhorar o aspecto estético, preserva os painéis da corrobção, aumentando a sua vida útil;
- no caso em que a caldeira de parede seja colocada dentro de móveis suspensos, deve ser deixado um espaço de pelo menos 5 cm por parte para a ventilação e para permitir a manutenção;
- a instalação de um termóstato ambiente favorecerá um conforto maior, uma utilização mais racional do calor e uma economia energética; a caldeira pode além disso ser combinada a um relógio programador para gerir acendimentos e desligamentos no arco do dia ou da semana.

### 2A ACENDIMENTO

O primeiro acendimento da caldeira deve ser efectuado por pessoal do Centro de Assistência Técnica. Sucessivamente, quando for necessário colocar o aparelho em serviço, seguir atentamente as operações descritas.

Para o acendimento da caldeira é necessário efectuar as seguintes operações:

- alimente a caldeira
- abra a torneira do gás presente no sistema para permitir o fluxo do combustível
- gire o selector de modo (1 - fig. 1a) para a posição desejada:

**Ciao S C.S.I.:**

**Modo verão:** girando o selector para o símbolo verão "☀" (fig. 2a), activa-se a função tradicional de somente água quente sanitária. Se houver uma solicitação de água quente sanitária, o mostrador digital mostra a temperatura do sistema de água quente, o ícone para indicar o suprimento de água quente e o ícone de chama

**Modo Inverno:** girando o selector de função dentro da zona marcada + e - (fig. 2b), a caldeira fornece água quente sanitária e aquecimento. Se houver um pedido de calor, a caldeira liga e o monitor digital indica a temperatura da água em aquecimento, o ícone para indicar o aquecimento e o ícone de chama (fig. 3a). Se houver uma solicitação de água quente sanitária, a caldeira liga e o mostrador digital mostra a temperatura do sistema de água quente, o ícone para indicar o suprimento de água quente e o ícone de chama (fig. 4a)

**Pré-aquecimento** (água quente mais rápido): gire o manípulo de regulação de temperatura de água quente sanitária (2 - fig. 1a) para o símbolo ☺ (fig. 5a) para activar a função de pré-aquecimento. Esta função permite manter aquecida a água contida no intercambiador sanitário para reduzir os tempos de espera durante o fornecimento. Quando a função de pré-aquecimento está habilitada, o monitor indica a temperatura do caudal da água de aquecimento ou da água quente sanitária, com base na solicitação em curso. Durante o acendimento do queimador, após uma solicitação de pré-aquecimento, o monitor mostra o símbolo P (fig. 5b). Para desactivar a função pré-aquecimento, gire novamente o manípulo de regulação da temperatura da água quente sanitária para o símbolo ☺. Colocar o manípulo de regulação da temperatura da água sanitária na posição desejada. A função não está activa com a caldeira no estado OFF: selector de função (1 fig. 1a) em ⏻ desligado (OFF).

**Ciao S R.S.I.:**

**Modo verão (apenas com o reservatório de água externa conectado):** girando o selector para o símbolo verão ☀ (fig. 2a), é activada apenas a função tradicional da água quente sanitária e a caldeira fornece água à temperatura definida no reservatório de armazenamento externo. Se houver uma solicitação de água quente sanitária, o mostrador digital mostra a temperatura do sistema de água quente, o ícone para indicar o suprimento de água quente e o ícone de chama

**Modo Inverno:** girando o selector de função dentro da zona marcada + e - (fig. 2b), a caldeira fornece água quente para aquecimento e - se conectada a um reservatório de armazenamento externo - água quente sanitária. Se houver um pedido de calor, a caldeira liga e o monitor digital indica a temperatura da água em aquecimento, o ícone para indicar o aquecimento e o ícone de chama (fig. 3a). Se houver uma solicitação de água quente sanitária, a caldeira liga e a tela digital mostra a temperatura do sistema de água quente, o ícone para indicar o suprimento de água quente e o ícone de chama (fig. 4a).

Regular o termóstato ambiente na temperatura desejada (~20°C)

#### Ciao S C.S.I.: Regulação da temperatura da água quente sanitária

Para regular a temperatura da água sanitária (banheiros, duches, cozinha, etc.), gire o manípulo com o símbolo "☀" (fig. 2b) dentro da área marcada + e -. A caldeira está em status de espera até que, depois de um pedido de calor, o queimador liga e o mostrador digital mostra a temperatura do sistema de água quente, o ícone para indicar o suprimento de água quente e o ícone de chama

A caldeira ficará em função até que sejam alcançadas as temperaturas reguladas, depois disso colocar-se-á novamente em estado de "stand-by". Se a luz indicadora vermelha próxima ao símbolo ⚠ no painel de comando acender, isto significa que a caldeira está em status de paragem temporária (consulte o capítulo sobre sinais de luz e anomalias). O display digital mostra o código da anomalia encontrado (fig. 6a).

#### Ciao S R.S.I.: Regulação da temperatura da água sanitária

**CASO A** apenas aquecimento - regulação não aplicável

**CASO B** apenas aquecimento + ebulidor externo com termóstato - regulação não aplicável.

**CASO C** apenas aquecimento + reservatório de armazenamento externo com sonda - para ajustar a temperatura da água quente sanitária no reservatório de armazenamento, gire o manípulo com o

símbolo em sentido horário para aumentar a temperatura da água e anti-horário para diminuí-la.

A caldeira está em status de espera até que, depois de um pedido de calor, o queimador liga e o mostrador digital mostra a temperatura do sistema de água quente, o ícone para indicar o suprimento de água quente e o ícone de chama

A caldeira ficará em função até que sejam alcançadas as temperaturas reguladas, depois disso colocar-se-á novamente em estado de "stand-by".

Se a luz indicadora vermelha próxima ao símbolo  no painel de comando indicar, isto significa que a caldeira está em status de paragem temporária (consulte o capítulo sobre sinais de luz e anomalias). O monitor digital mostra o código da avaria detectado (fig. 6a)

**Ciao S C.S.I. - Ciao S R.S.I.: Função Sistema Automático Regulação Ambiente (S.A.R.A.) fig. 7a**

Posicionando o selector da temperatura da água do aquecimento na zona assinalada pela escrita AUTO - valor de temperatura de 55 a 65°C-, activa-se o sistema de auto-regulação S.A.R.A.: a caldeira varia a temperatura de envio em função do sinal de fechamento do termóstato ambiente. Ao alcançar a temperatura configurada com o selector de temperatura da água do aquecimento, inicia uma contagem de 20 minutos. Se durante este período o termóstato ambiente continua a exigir calor, o valor da temperatura configurada aumenta automaticamente em 5 °C.

Ao alcançar o novo valor configurado começa uma contagem de outros 20 minutos.

Se durante este período o termóstato ambiente continua a exigir calor, o valor da temperatura configurada aumenta automaticamente em outros 5 °C.

Este novo valor de temperatura é o resultado da temperatura configurada manualmente com o selector de temperatura da água de aquecimento e o aumento de +10 °C da função S.A.R.A.



Depois do segundo ciclo, o valor da temperatura deve ser mantido no valor configurado de +10 °C até que a solicitação do termóstato ambiente seja satisfeita.

**3A DESLIGAMENTO**

**Desligamento temporário**

No caso de ausência por curtos períodos de tempo, configure o selector de modo (1 - fig. 1a) para  (OFF).

Deste modo, deixando activadas a alimentação eléctrica e a alimentação do combustível, a caldeira é protegida por sistemas:

- **Dispositivo antigelo:** quando a temperatura da água da caldeira cai abaixo de 5°C activa-se o circulador e, se necessário, o queimador na potência mínima para levar a temperatura da água a valores de segurança (35°C). Durante o ciclo anticongelamento, no monitor digital aparece o símbolo .
- **Função antibloqueio do circulador:** um ciclo de funcionamento é activado a cada 24 horas.
- **Anticongelamento DHW (apenas quando conectado a um reservatório de armazenamento externo com sonda):** a função activa-se se a temperatura detectada pela sonda do ebulidor descer abaixo de 5°C. Nessa fase é gerado um pedido de calor com acendimento do queimador à mínima potência, que é mantida até a temperatura da água de descarga alcança 55°C. Durante o ciclo anticongelamento, no monitor digital aparece o símbolo .

**Desligamento por longos períodos**

Em caso de ausências prolongadas, posicione o selector de modo (1 - fig. 1a) em  (OFF).

Fechar então a válvula do gás presente na instalação. Neste caso a função antigelo é desactivada: esvaziar as instalações se houver risco de gelo.

**4A CONTROLOS**

















Certificar-se no início da estação de aquecimento e de vez em quando durante a utilização, que o hidrómetro-termohidrómetro indique valores de pressão de instalação fria, compreendidos entre 0,6 e 1,5 bar: isso evita ruídos da instalação devidos à presença de ar. Em caso de circulação de água insuficiente a caldeira se desligará. Em nenhum caso a pressão da água deve ser inferior a 0,5 bar (campo vermelho).

No caso em que se verifique essa condição, é necessário restabelecer a pressão da água na caldeira procedendo como descrito a seguir:



- coloque o selector de modo (2 - fig.1a) em  desligado (OFF)
- abra a torneira de enchimento (L fig. 13 para C.S.I. - externo para R.S.I.) até que o valor da pressão esteja entre 1 e 1,5 bar. Fechar cuidadosamente a válvula.
- Recolocar o selector de função na posição inicial.
- Se a queda de pressão for muito frequente, solicitar a intervenção do Centro de Assistência Técnica.

**5A SINALIZAÇÕES LUMINOSAS E ANOMALIAS**

O estado de funcionamento da caldeira é indicado pelo monitor digital, a seguir são mostrados os tipos de visualização.

STATUS DA CALDEIRA	MONITOR
Em espera	-
Status OFF	OFF
Alarme de bloqueio do módulo ACF	A01 
Alarme de falha eléctrica ACF	A01 
Alarme de termóstato de limite	A02 
Alarme de pressostato de ar	A03 
Alarme de pressostato H2O	A04 
Avaria de água quente sanitária NTC (C.S.I. e R.S.I apenas com aquecedor de armazenamento externo com sonda)	A06 
Avaria de aquecimento NTC	A07 
Chama parasita	A11 
Calibragem eléctrica aquecimento min e max	ADJ 
Ignição de espera transitória	88 °C intermitente
Intervenção do pressostato de ar	 intermitente
Intervenção do pressostato de H2O	 intermitente
Função de pré-aquecimento activa (apenas C.S.I.)	P
Pedido de calor de pré-aquecimento (apenas C.S.I.)	P intermitente
Sonda externa presente	
Pedido de calor de água sanitária	60 °C 
Pedido de calor de aquecimento	80 °C 
Pedido de calor anticongelamento	
Presença de chama	

**Para restabelecer o funcionamento (desbloqueio de alarmes): Anomalias A 01-02-03**



Posicione o selector de função em  desligado (OFF), espere 5-6 segundos e coloque-o na posição desejada  (verão) ou  (inverno).

Se as tentativas de desbloqueio não reactivam a caldeira, solicitar a intervenção do Serviço Técnico de Assistência.

**Anomalia A 04**

O display digital exhibe, além do código da anomalia, o símbolo .

Verificar o valor de pressão indicado pelo hidrómetro:

Se for menor que 0,3 bar, posicione o selector de função em  (OFF) e ajuste a torneira de enchimento (L fig. 13 para C.S.I. - externo para R.S.I.) até que a pressão alcance um valor entre 1 e 1,5 bar. Então gire o selector de modo para a posição desejada  (verão) ou  (inverno).

A caldeira executará um ciclo de ventilação com duração de aproximadamente 2 minutos.

Se as quedas de pressão são frequentes, solicitar a intervenção do Serviço Técnico de Assistência.

**Avaria A 06 (apenas C.S.I.)**

A caldeira funciona normalmente, mas não garante a estabilidade da temperatura da água sanitária, que permanece programada em torno de 50 °C. Entre em contacto com o Centro de Assistência Técnica.

**Anomalia A 07**

Solicitar a intervenção do Serviço Técnico de Assistência.

## DADOS TÉCNICOS

DESCRIÇÃO			CIAO 20 S C.S.I.	CIAO 24 S C.S.I.	CIAO 24 S R.S.I.
<b>Aquecimento</b>	Potência térmica	kW	22,20	25,80	25,80
		kcal/h	19.092	22.188	22.188
	Potência térmica máxima	kW	20,60	23,94	23,94
		kcal/h	17.717	20.590	20.590
	Potência térmica mínima	kW	7,00	8,90	8,90
		kcal/h	6.020	7.654	7.654
	Potência térmica mínima	kW	5,88	7,61	7,61
		kcal/h	5.057	6.544	6.544
<b>DHW</b>	Potência térmica	kW	22,20	25,80	-
		kcal/h	19.092	22.188	-
	Potência térmica máxima	kW	20,60	23,94	-
		kcal/h	17.717	20.590	-
	Potência térmica mínima	kW	7,00	8,90	-
		kcal/h	6.020	7.654	-
	Potência térmica mínima	kW	5,88	7,61	-
		kcal/h	5.057	6.544	-
	Rendimento útil Pn máx - Pn mín	%	92,8 - 84,0	92,8 - 85,5	92,8 - 85,5
	Rendimento útil 30% (47° retorno)	%	91,9	90,9	90,9
	Rendimento de combustão	%	93,2	93,0	93,0
	Potência eléctrica	W	100	116	116
	Categoria		II2H3+	II2H3+	II2H3+
	País de destino		-	-	-
	Tensão de alimentação	V - Hz	230-50	230-50	230-50
	Grau de protecção	IP	X5D	X5D	X5D
	Perdas na chaminé com queimador ligado	%	6,85	6,96	6,96
	A pressão cai na chaminé com o queimador desligado	%	0,09	0,07	0,07
<b>Exercício aquecimento</b>					
	Pressão – temperatura máxima	bar-°C	3 - 90	3 - 90	3 - 90
	Pressão mínima para funcionamento padrão	bar	0,25 - 0,45	0,25 - 0,45	0,25 - 0,45
	Campo de selecção da temperatura de água de aquecimento	°C	40/80	40/80	40/80
	Bomba: prevalência máxima disponível para a instalação	mbar	300	300	300
	na vazão de	l/h	1.000	1.000	1.000
	Vaso de expansão de membrana	l	7	8	8
	Pré-carga vaso de expansão	bar	1	1	1
<b>Exercício circuito sanitário</b>					
	Pressão máxima	bar	6	6	-
	Pressão mínima	bar	0,15	0,15	-
	Quantidade de água quente com $\Delta t$ 25°C	l/min	11,8	13,7	-
	com $\Delta t$ 30°C	l/min	9,8	11,4	-
	com $\Delta t$ 35°C	l/min	8,4	9,8	-
	Potência mínima DHW	l/min	2	2	-
	Campo de selecção da temperatura H2O sanitária	°C	37/60	37/60	-
	Regulador de fluxo	l/min	8	10	-
<b>Pressão do gás</b>					
	Pressão nominal gás metano (G20)	mbar	20	20	20
	Pressão nominal gás líquido G.P.L. (G30/G31)	mbar	28-30/37	28-30/37	28-30/37
<b>Conexões hidráulicas</b>					
	Entrada - saída aquecimento	Ø	3/4"	3/4"	3/4"
	Entrada - saída sanitário	Ø	1/2"	1/2"	-
	Caudal - potência do aquecimento	Ø	-	-	3/4"
	Entrada gás	Ø	3/4"	3/4"	3/4"
<b>Dimensões da caldeira</b>					
	Altura	mm	715	715	715
	Largura	mm	405	405	405
	Profundidade no revestimento	mm	248	248	248
	Peso caldeira	kg	29	31	28
<b>Caudais (G20)</b>					
	Caudal ar	Nm <sup>3</sup> /h	36,875	39,613	39,613
	Caudal fumos	Nm <sup>3</sup> /h	39,101	42,204	42,204
	Caudal máximo fumos (máx-mín)	gr/s	13,310 - 14,540	14,308-16,247	14,308-16,247
<b>Caudais (G30)</b>					
	Caudal ar	Nm <sup>3</sup> /h	35,328	40,249	40,249
	Caudal fumos	Nm <sup>3</sup> /h	36,955	41,008	41,008
	Caudal máximo fumos (máx-mín)	gr/s	13,100 - 14,030	13,985 - 16,429	13,985 - 16,429

DESCRIÇÃO		CIAO 20 S C.S.I.	CIAO 24 S C.S.I.	CIAO 24 S R.S.I.
<b>Caudais (G31)</b>				
Caudal ar	Nm³/h	36,405	40,454	40,454
Caudal fumos	Nm³/h	38,119	41,455	41,455
Caudal máximo fumos (máx-mín)	gr/s	13,480 - 14,280	14,120 - 16,683	14,120 - 16,683
<b>Prestações do ventilador</b>				
Prevalência residual caldeira sem tubos	Pa	43	110	110
<b>Tubos de descarga de fumos concêntricos</b>				
Diâmetro	mm	60-100	60 - 100	60 - 100
Comprimento máximo	m	4,25	4,25	4,25
Perda para a introdução de uma curva 45°/90°	m	1 - 1,5	1 - 1,5	1 - 1,5
Furo de atravessamento parede (diâmetro)	mm	105	105	105
<b>Tubos de descarga de fumos concêntricos</b>				
Diâmetro	mm	80-125	80-125	80-125
Comprimento máximo	m	12,40	12,4	12,4
Perda para a introdução de uma curva 45°/90°	m	1,35 - 2,2	1,35 - 2,2	1,35 - 2,2
Furo de atravessamento parede (diâmetro)	mm	130	130	130
<b>Tubos descarga de fumos separados</b>				
Diâmetro	mm	80	80	80
Comprimento máximo	m	10 + 10	16 + 16	16 + 16
Perda para a introdução de uma curva 45°/90°	m	1,2 - 1,7	1,2 - 1,7	1,2 - 1,7
<b>Instalação B22P-B52P</b>				
Diâmetro	mm	80	80	80
Comprimento máximo de descarga	m	14	25	25
Classe Nox		3	3	3
<b>Valores de emissões com caudal máximo e mínimo com gás G20*</b>				
Máximo - Mínimo CO s.a. inferior a	ppm	100 - 180	120 - 200	120 - 200
CO <sub>2</sub>	%	7,1 - 2,0	7,3 - 2,2	7,3 - 2,2
NOx s.a. inferior a	ppm	180 - 100	200 - 100	200 - 100
Temperatura dos fumos	°C	127 - 97	142 - 109	142 - 109

\* Verificação realizada com tubo concêntrico Ø 60-100 - comp. 0,85 m - temperatura da água 80-60°C

Queimador

**Tabela multigás**

DESCRIÇÃO		Gás metano (G20)			Butano (G30)			Propano (G31)		
		20 S C.S.I.	24 S C.S.I.	24 S R.S.I.	20 S C.S.I.	24 S C.S.I.	24 S R.S.I.	20 S C.S.I.	24 S C.S.I.	24 S R.S.I.
Índice de Wobbe inferior (a 15°C-1013 mbar)	MJ/m³S	45,67			80,58			70,69		
Poder calorífico inferior	MJ/m³S	34,02			116,09			88		
Pressão nominal de alimentação	mbar (mm W.C.)	20 (203,9)			28 - 30 (285,5 - 305,9)			37 (377,3)		
Pressão mínima de alimentação	mbar (mm W.C.)	13,5 (137,7)			-			-		
Queimador número de furos	n°	11			11			11		
Queimador diâmetro dos furos	mm	1,30	1,35	1,35	0,75	0,78	0,78	0,75	0,78	0,78
Caudal gás máximo aquecimento	Sm³/h	2,35	2,73	2,73						
	kg/h				1,75	2,03	2,03	1,72	2,00	2,00
Caudal de gás máximo circuito sanitário	Sm³/h	2,35	2,73	-						
	kg/h				1,75	2,03	-	1,72	2,00	-
Caudal gás mínimo aquecimento	Sm³/h	0,74	0,94	0,94						
	kg/h				0,55	0,70	0,70	0,54	0,69	0,69
Caudal de gás mínimo circuito sanitário	Sm³/h	0,74	0,94	-						
	kg/h				0,55	0,70	-	0,54	0,69	-
Pressão máxima à jusante da válvula em aquecimento	mbar	10,40	11,80	11,80	28,00	27,80	27,80	36,00	35,80	35,80
	mm W.C.	106,05	120,33	120,33	285,52	283,48	283,48	367,10	365,06	365,06
Pressão máxima à jusante da válvula em sanitário	mbar	10,40	11,80	-	28,00	27,80	-	36,00	35,80	-
	mm W.C.	106,05	120,33	-	285,52	283,48	-	367,10	365,06	-
Pressão mínima à jusante da válvula em aquecimento	mbar	1,20	1,50	1,50	3,00	3,30	3,30	3,90	4,30	4,30
	mm W.C.	12,24	15,30	15,30	30,59	33,65	33,65	39,77	43,85	43,85
Pressão mínima à jusante da válvula em sanitário	mbar	1,20	1,50	-	3,00	3,30	-	3,90	4,30	-
	mm W.C.	12,24	15,30	-	30,59	33,65	-	39,77	43,85	-

## TR KURULUM

### 1 - GENEL GÜVENLİK CİHAZLARI

- ⚠️ Kombilerimiz tesislerimizde imal edilmektedir ve kullanıcıları ve montörleri yaralanmadan korumak için en küçük ayrıntısına kadar kontrol edilmektedir. Kalifiye personel ürün üzerinde çalıştıktan sonra elektrik kablosunu ve bilhassa terminal kutusundan dışarı çıkmaması gereken iletkenin sıyrılmış kısımlarını, olası bir temastan kaçınarak kontrol etmelidir.
- ⚠️ Bu kurulum kılavuzu, kullanım kılavuzu ile birlikte, ürünün tamamlayıcı parçasıdır: başka bir kullanıcıya / cihaz sahibine verilmesi veya başka bir ısıtma sistemine taşınması halinde cihazla birlikte verildiğinden emin olun. Herhangi bir kayıp veya hasar halinde yeni bir kopya için yerel Teknik Yardım Servisi ile irtibata geçiniz.
- ⚠️ Kombi kurulumu ve diğer yardım-bakım işlemleri, yürürlükteki yerel ve ulusal yönetmeliklere göre vasıflı personel tarafından gerçekleştirilmelidir.
- ⚠️ Montör, kullanıcıyı cihazın çalışması ve temel güvenlik düzenlemeleri hakkında bilgilendirmelidir.
- ⚠️ Bu kombi sadece maksadına uygun olarak kullanılmalıdır. Üretici yanlış kullanım ile kurulum, ayarlama ve bakımdan doğabilecek mülke hasar ya da kişilere veya hayvanlara yönelik yaralanmalarda, sözleşmede yer alan yahut almayan her tür yükümlülüğü peşinen reddeder.
- ⚠️ Ambalajı çıkardıktan sonra, içeriğin iyi durumda ve eksiksiz olduğundan emin olun. Aksi halde, cihazınızı satın aldığınız satıcı ile irtibata geçiniz.
- ⚠️ Emniyet valfi çıkışı uygun tahliye ve havalandırma sistemine bağlanmalıdır. Üretici emniyet valfine yapılan herhangi bir müdahale nedeniyle meydana gelen herhangi bir hasar durumunda tüm yükümlülüğü reddeder.
- ⚠️ Tüm ambalaj malzemesini, toplama merkezlerindeki uygun konteynerlerde izale edin.
- ⚠️ Atığı, çevreye zarar vermeyen prosedürler veya yöntemler kullanılarak ve insan sağlığına zarar vermeden, dikkatlice bertaraf edin.

Kurulum süresince kullanıcıyı aşağıdaki hususlarda bilgilendiriniz:

- Su kaçağı olması halinde su besleme kapatılmalıdır ve Teknik Yardım Servisi derhal bilgilendirilmelidir
- Hidrolik sistem çalışma basıncı 1 ve 2 bar içerisinde olmalı ve dolayısıyla 3 barı aşmamalıdır. İhtiyaç halinde, basıncı "Sistemi doldurma" başlıklı paragrafta gösterildiği gibi sıfırlayın
- Kombi uzunca bir süre kullanılmayacaksa Teknik Yardım Servisinin en azından aşağıdaki işlemleri yerine getirmesi önerilir:
  - Sistem genel anahtarı ve cihaz ana anahtarını kapatın
  - Hem ısıtma hem de şebeke sıcak su devrelerindeki gaz ve su musluklarını kapayın
  - Donmayı önlemek için ısıtma ve şebeke sıcak su devresini tahliye edin
- Kombi bakımı en az yılda bir kez yapılmalıdır. Bunun için Teknik Yardım Servisinden önceden randevu alın.

Güvenlik için her zaman aşağıdaki hususları hatırd tutun:

- ⊘ Kombi çocuklar veya yardımcısı olmayan özürü kişiler tarafından kullanılmamalıdır.
- ⊘ Gaz veya duman kokusu alınması halinde anahtar, ev aletleri vb. elektrikli cihazları etkinleştirmek tehlikelidir. Gaz kaçağı olması halinde kapı ve pencereleri açarak odayı havalandırın; genel gaz musluğunu kapatın; derhal Teknik Yardım Servisinin kalifiye personelle irtibata geçin

- ⊘ Yalınayaksanız veya vücudunuzun bir kısmı ıslak veya nemli ise kombiye dokunmayın
- ⊘ Cihazı temizlemeden önce, iki konumlu sistem anahtarı ve ana kontrol panel anahtarını kapatarak ana güç kaynağından kombi bağlantısını kesin
- ⊘ Üreticinin izni ve ilgili talimatlar olmadan güvenlik ve ayar cihazlarını modifiye etmeyin
- ⊘ Ana güç beslemesine bağlı olmasa bile kombiden gelen elektrik kablolarını çekmeyiniz, bağlantısını kesmeyiniz veya bükmeyiniz
- ⊘ Kurulum odasının havalandırma açıklığını kapatmaktan veya küçültmekten sakınız
- ⊘ Kurulum odasında yanıcı kaplar ve maddeler bırakmayınız
- ⊘ Ambalaj malzemelerini çocuklardan uzak tutunuz.

### 2 - KOMBİ Açıklaması

**Ciao S C.S.I.** sıcak su ısıtma ve üretimi için C-tipi duvara monte edilebilen bir kombidir: baca gazı çıkış cihazına göre, kombi şu kategorilerde sınıflandırılmaktadır: B22P, B52P, C12, C22, C32, C42, C52, C62, C82, C92, C12x, C32x, C42x, C52x, C62x, C82x, C92x.

**Ciao S R.S.I.** çeşitli modda fonksiyon gösteren C tipi duvara monte edilen kombidir:

#### MOD A

Bağlı olan harici bir depolama tankı olmadan ısıtma. Kombi şebeke sıcak suyu vermez.

#### MOD B

Yalnızca bağlanmış bir termostatik kontrollü harici depolama tankı ile ısıtma: bu durumda, depo tankı termostatından her ısı isteği ile kombi evde kullanım için sıcak su temin eder.

#### MOD C

Yalnızca bağlanmış bir termostatik kontrollü harici depolama tankı (sıcaklık probu tarafından yönetilen) (isteğe bağlı aksesuar kiti) ile evde kullanım için ısıtma. Tarafımızdan tedarik edilmeyen tankı bağlarken, NTC' nin aşağıdaki özelliklere sahip olduğundan emin olunuz: 10 kOhm ; 25°C de, B 3435 ±%1

Yapılandırma B22P ve B52P'de (iç mekanda kurulu iken), cihaz yatak odası, banyo, duş veya uygun hava akışı olmayan açık şöminelerin bulunduğu yerlerde monte edilemez. Kombin monte edildiği odada yeterli havalandırma olmalıdır. Yapılandırma C'de, cihaz her türlü odada kurulabilir ve havalandırma koşulları ya da oda hacmi nedeniyle bir sınırlama söz konusu değildir.

### 3 - KURULUM TALİMATLARI

#### 3.1 - Kurulum talimatları

Kurulum yetkili personel tarafından yapılmalıdır. Her zaman ulusal ve yerel düzenlemelere uyulmalıdır.

#### KONUM

**Ciao S** iç mekanda kurulabilir (şekil. 2). Kombi 0°C ila 60°C sıcaklık aralığında düzgün çalışmayı garanti eden bir korumaya sahiptir. Herhangi bir kilitleme durumu (örneğin gaz veya elektrik besleme yokluğu veya güvenlik müdahalesi) korumayı devre dışı bırakacağından, korumadan faydalanmak için cihaz başlatılabilir.

Kılavuzun bazı kısımlarında bazı semboller kullanılmıştır:

- ⚠️ UYARI = özel alaka ve uygun hazırlık gerektiren işlemler
- ⊘ YASAK = yapılmaması gereken işlemler

**MİNİMUM MESAFE**

Düzenli bakım yapabilmek üzere kombiye erişebilmek için kurulumda öngörülen minimum mesafelere uyunuz (şekil. 3).

Doğru cihaz konumlama için:

- Bir ocak ya da benzeri pişirme cihazları üzerine koymayın
- Kombinın kurulu olduğu odada yanıcı ürün bırakmayın
- Isıya duyarlı duvarlar (örneğin, ahşap duvarlar) düzgün yalıtım ile korunmalıdır.

**ÖNEMLİ**

Kurulumdan önce, cihazın çalışmasını bozabilecek herhangi bir kalıntıyı ortadan kaldırmak için bütün sistem borularını dikkatlice yıkayın. Isıtma sisteminin aşırı basıncı sebebiyle kaçak olması halinde, emniyet valfi altına uygun bir tahliye borusuna sahip bir su toplama kanalı yerleştirin. Şebeke sıcak su devresinde emniyet valfine ihtiyaç yoktur, ancak su tertibatının 6 barı aşmadığından emin olun. Şüphe duyuyorsanız, bir basınç azaltıcı kurun.

Ateşleme öncesinde, kombinın mevcut gazla çalışmaya yönelik tasarlandığından emin olun; bu, ambalaj üzerindeki mesajdan ve gaz türünü belirten çıkartma etiketten kontrol edilebilir.

Bazı durumlarda duman borularının basınç altında bulunduğu; bu nedenle çeşitli eleman bağlantılarının hava geçirmez olması gerektiğine dikkat etmek son derece önemlidir.

**ANTİFRİZ SİSTEMİ**

Kombi standart olarak, ana devredeki su sıcaklığı 6 °C'nin altına düştüğünde etkin hale gelen otomatik antifriz (donmaya karşı emniyet) sistemiyle donatılmıştır. -3 °C dış mekan sıcaklığına kadar kombi korumasını garanti eden bu sistem, daima aktiftir. (Brülör çalışmasına dayalı) bu korumadan faydalanabilmek için kombi açık durumda olmalıdır; (gaz/elektrik besleme eksikliği veya güvenlik cihazı müdahalesi gibi) herhangi bir kilitlenme durumu, korumayı devre dışı bırakacaktır. Donmaya karşı koruma, kombi bekleme durumundayken bile aktif haldedir. Normal çalışma durumunda kombi kendini donmaya karşı koruyacaktır. Sıcaklığın 0 °C'nin altına düştüğü alanlarda makine uzunca süre çalışmadan bırakılırsa ve ısıtma sistemini tahliye etmek istemiyorsanız, ana devreye özel ve iyi kalite bir donma önleyici sıvı ilave etmeniz önerilir. Makine devresini tutmak istediğiniz minimum sıcaklıkta kullanılacak antifriz sıvısı oranları ile sıvının kullanım süresi ve izalesiyle ilgili olarak üreticinin talimatlarına titizlikle uyunuz.

Şebeke sıcak suyu açısından devreyi tahliye etmeniz önerilir. Kombi bileşen malzemeleri, etilen glikol bazlı antifriz sıvısına dirençlidir.

**3.2 Kombiyi duvar ve hidrolik bağlantılara sabitleme**

Kombiyi duvara sabitlemek için, ambalajdaki karton şablonu kullanın (şekil 4-5). Hidrolik bağlantı konumu ve büyüklüğü aşağıda belirtilmiştir:

<b>A</b>	CH dönüş	3/4"
<b>B</b>	CH tahliye	3/4"
<b>C</b>	Gaz bağlantısı	3/4"
<b>D</b>	DHW çıkış	1/2" (C.S.I. için) - 3/4" (R.S.I. için)
<b>E</b>	DHW giriş	1/2" (C.S.I. için) - 3/4" (R.S.I. için)

Önceki model Beretta kombinın değiştirilmesi halinde mevcut hidrolik bağlantılara uyarlama kiti bulunmaktadır.

**3.3 Elektrik bağlantısı**

Kombiler güç kablosu tamamen bağılyken fabrikadan çıkmaktadır ve sadece belirli terminalerde yapılacak ortam termostat (AT) bağlantısına ihtiyaç duymaktadır.

Terminal levhasına erişmek için:

- Sistem genel anahtarını kapayın
- Gövdedeki sabitleme vidalarını (A) sökün (şekil 6)
- Gövde tabanı kasadan kurtulana kadar ileri ve ardından yukarı kaldırın
- Cihaz paneli sabitleme vidasını (B) sökün (şekil 7)
- Gösterge panelini ters yüz edin (baş aşağı çevirin)
- Terminal levha kapağını sökün (şekil 8)
- Olası T.A kablosunu takın (şekil 9)

Ortam termostatu, gösterildiği gibi bağlanmalıdır.

**⚠ Emniyetli alçak gerilimde (24 Vdc) ortam termostatu girişi.**

Şebeke beslemesine bağlantı en az 3,5 mm omnipolar açıklığı olan ayrı bir cihaz ile yapılmalıdır (EN 60335-1, kategori III).

Cihaz 230 Volt/50 Hz alternatif akım ve 20 C.S.I. başına 100W ve 24 C.S.I. başına 115W ile 24 R.S.I. başına elektrik gücüyle çalışmaktadır (ve EN 60335-1 standardına uygunluk göstermektedir).

⚠ Ulusal ve yerel mevzuata göre verimli toprak devreye bağlantı yapmak zorunludur.

⚠ Nötr faz bağlantısına uygunluk göstermesi önerilir (L-N).

⚠ Toprak tel, diğerlerine göre birkaç santimetre daha uzun olmalıdır.

⚠ **Elektrikli cihazı topraklamak için gaz ve/veya su borularını kullanmayın.**

Cihaz toprak devreye bağlı değilse, üretici herhangi bir hasarda yükümlülüğü reddeder.

Kombiyi ana güç kaynağına bağlamak için üreticinin tedarik ettiği **tedarik ettiği güç kablosunu** kullanın.

**Güç kablosu yenisi ile değiştirilecekse maksimum dış çapı 7 mm olan HAR H05V2V2-F, 3 x 0.75 mm<sup>2</sup> kablo tipi kullanın.**

**3.4 Gaz bağlantısı**

Cihazı gaz şebekesine bağlamadan önce şunları kontrol edin:

- Ulusal ve yerel yönetmeliklere uygunluk göstermelidir
- Gaz türü cihaza uygun olmalıdır
- Borular temiz olmalıdır.

Gaz borusu dışarıya kurulmalıdır. Boru duvarlardan geçecekse şablonun alt kısmında merkezi açıklıktan geçmelidir.

Dağıtım aşında katı parçacıklar varsa gaz hattına uygun boyutlarda bir filtre kurulması önerilir.

Cihaz kurulduğunda bağlantıların mevcut kurulum yönetmeliklerine göre mühürlenip mühürlenmediğini kontrol ediniz

**3.5 Duman çıkışı ve hava emişi**

Duman çıkışı için, yürürlükteki yerel ve ulusal yönetmeliklere bakın. Her zaman Yangın Departmanı, Gaz Şirketi standartları ve olası belediye yönergelerine uygunluk gösterin.

Yanma ürünlerinin salınımı, yanma odası içine yerleştirilen bir santrifüj fan tarafından güvence altına alınmıştır ve doğru çalışması sürekli olarak bir basınç anahtarıyla kontrol edilmektedir. Cihazda, kurulum özelliklerine daha iyi uyum gösteren çekişi güçlü sızdırmaz bir bölmeye sahip bazı aksesuarlar kullanmak mümkün olduğundan kombi, baca gazı çıkışı / hava emişi kiti olmadan verilir.

Baca gazı salınımı ve kombi yanma havası restorasyonu için sertifikalı borular kullanmak son derece önemlidir ve bağlantı, baca gazı aksesuarlarıyla birlikte verilen talimatlar uyarınca yapılmalıdır. Sadece bir duman borusuyla, her parçasının sızdırmaz bir bölmeye sahip bulunması koşuluyla cihaza birden fazla parça bağlayabilirsiniz.

**"CEBRİ AÇMALI" KURULUM (TİP B22P/B52P)****Duman çıkış kanalı Ø 80 mm (Şekil 10a)**

Duman çıkış kanalı, kurulum ihtiyaçlarına göre en uygun yönelimde düzenlenebilir. Kurulum için, kitle birlikte gelen yönergeleri izleyiniz.

⚠ Bu yapılandırmada, kombi, bir Ø 60-80 mm adaptör vasıtasıyla Ø 80 mm duman çıkış kanalına bağlanır.

Bu durumda, yanmayı destekleyici hava, kombinın kurulu olduğu uygun ve havalandırılmalı bir teknik odadan alınır.

⚠ İzolasyonsuz duman çıkış kanalları, potansiyel tehlike kaynaklarıdır.

Baca gazı flanşı (L), ihtiyaç halinde bir tornavidayı manivela olarak kullanmak suretiyle kaldırılmalıdır.

Kombi, havalandırmayı, otomatik olarak kanalın kurulumuna ve uzunluğuna göre ayarlar.

**20 C.S.I.**

Boru uzunluğu Ø 80 [m]	Baca gazı flanşı (F)	Her dirsek için yük kaybı (m)	
		45°	90°
En fazla 1,5	Ø 39	1,2	1,7
1,5 ila 5	Ø 41 (**)		
5 ila 14	Ø 43		

(\*\*) kombide yer alan



## 24 C.S.I. - 24 R.S.I.

Boru uzunluğu Ø 80 [m]	Baca gazı flanşı (F)	Her dirsek için yük kaybı (m)	
		45°	90°
En fazla 2	Ø 42	1,2	1,7
2 ila 8	Ø 44 (**)		
8 ila 25	Kurulu değil		

(\*\*) kombide yer alan

## KONSANTRİK ÇIKIŞLAR (Ø 60-100)

Kombi konsantrik çıkış / emme borularına bağlanmak üzere tasarlanmıştır ve hava emişi için açıklıklar (E) kapalıdır (Şekil 10b). Konsantrik çıkışlar tabloda belirtilen maksimum uzunluklara uygun olarak odanın gereklerine göre en uygun yöne yerleştirilebilir. Kurulum için, kitle birlikte gelen yönergeleri izleyiniz.

Kullanılan boru uzunluğuna göre, kombide yer alanlardan birini (aşağıdaki tabloya bakınız) seçerek, bir flanş eklemek gerekir. Baca gazı flanşı (F), ihtiyaç halinde bir tornavidayı manivela olarak kullanmak suretiyle kaldırılmalıdır. Tablo izin verilen doğrusal uzunluğu gösterir. Kullanılan boru uzunluğuna göre, kombide yer alanlardan birini (aşağıdaki tabloya bakınız) seçerek, bir flanş eklemek gerekir.

## 20 C.S.I.

Boru uzunluğu Ø 60-100 [m]	Baca gazı flanşı (F)	Her dirsek için yük kaybı (m)	
		45°	90°
En fazla 0,85	Ø 39	1	1,5
0,85 ila 2,35	Ø 41 (**)		
2,35 ila 4,25	Ø 43		

(\*\*) kombide yer alan

## 24 C.S.I. - 24 R.S.I.

Boru uzunluğu Ø 60-100 [m]	Baca gazı flanşı (F)	Her dirsek için yük kaybı (m)	
		45°	90°
En fazla 0,85	Ø 42	1	1,5
0,85 ila 2,35	Ø 44 (**)		
2,35 ila 4,25	Kurulu değil		

(\*\*) kombide yer alan

## Konsantrik boru (Ø 80/125)

Kombi, konsantrik çıkış / emme borularına bağlanmak üzere tasarlanmıştır ve hava emişi için açıklıklar kapalıdır. Konsantrik çıkışlar tabloda belirtilen maksimum uzunluklara uygun olarak odanın gereklerine göre en uygun yöne yerleştirilebilir.

Kurulum için, kitle birlikte gelen yönergeleri izleyiniz. Duvardan geçmek için, Ø 140 mm delik açınız. Kullanılan boru uzunluğuna göre, kombide yer alanlardan birini (aşağıdaki tabloya bakınız) seçerek, bir flanş eklemek gerekir. Dış sıcaklığa ve boru uzunluğuna özellikle dikkat ediniz. Yoğuşum toplayıcısı kullanmanın zorunlu olup olmadığını anlamak için şemalara bakınız. 60 ° C'den düşük sıcaklıkta çalışması durumunda, bir yoğuşum toplayıcısı kullanmak zorunludur. Yoğuşum toplayıcısı kullanıldığında, toplayıcıya karşı % 1 baca egzoz borusu eğimi sağlanmalıdır.

Bir beyaz su çıkış borusuna yoğuşum sifonu bağlayınız.  
İzolasyonsuz çıkış boruları potansiyel tehlike kaynaklarıdır.

## 20 C.S.I.

Boru uzunluğu Ø 80 125 [m]	Baca gazı flanşı (F)	Her dirsek için yük kaybı (m)	
		45°	90°
0,96 ila 3,85	Ø 39	1,35	2,2
3,85 ila 7,85	Ø 41 (**)		
7,85 ila 12,40	Ø 43		

(\*\*) kombide yer alan

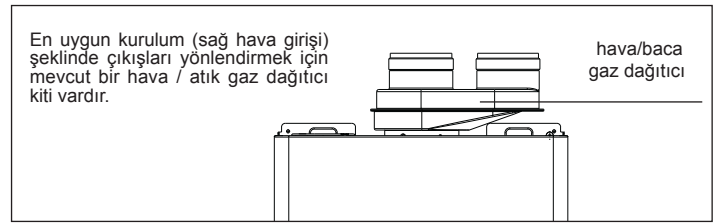
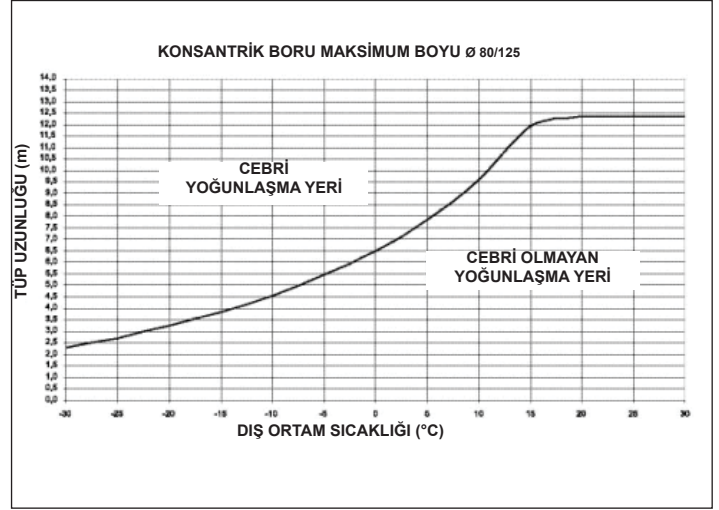

## azalan konsantrik dirsek kiti

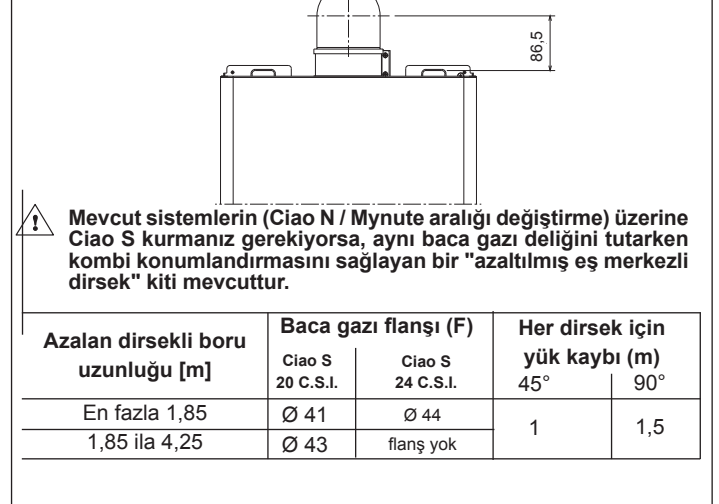

## 24 C.S.I. - 24 R.S.I.

Boru uzunluğu Ø 80 125 [m]	Baca gazı flanşı (F)	Her dirsek için yük kaybı (m)	
		45°	90°
0,96 ila 3,85	Ø 42	1,35	2,2
3,85 ila 7,85	Ø 44 (**)		
7,85 ila 12,4	Kurulu değil		

(\*\*) kombide yer alan

**İKİZ ÇIKIŞLAR (ø 80) (Şekil 11)**

İkiz çıkışlar odanın gereklerine göre en uygun yöne yerleştirilebilir. Yanma hava emme borusunu kullanmak için, iki girişten (G ve H) biri seçilmelidir. Vidalarla sabitlenen tıkaçı çıkarın ve seçilen girişe ilişkin özel adaptörü kullanın.

⚠ Hava giriş adaptörü ø 80 (X) doğru yönlendirilmelidir, bu nedenle uygun vidalar kullanarak gereken düzeltme yapılmalıdır; böylece yönlendirme sekmesi gövdeyle çakışmaz: X Hava giriş adaptörü ø 80 - Y hava giriş adaptörü ø 60 ø 80.

Baca gazı flanşı (F), ihtiyaç halinde bir tornavidayı manivela olarak kullanmak suretiyle kaldırılmalıdır. Tablo izin verilen doğrusal uzunluğu gösterir. Kullanılan boru uzunluğuna göre, kombide yer alanlardan birini (aşağıdaki tabloya bakınız) seçerek, bir flanş eklemek gerekir.

**20 C.S.I.**

Boru uzunluğu ø 80 [m]	Baca gazı flanşı (F)	Her dirsek için yük kaybı (m)	
		45°	90°
1+1	Ø 39		
> 1+1 ÷ 4+4	Ø 41 (**)	1,2	1,7
> 4+4 ÷ 10+10	Ø 43		

(\*\*) kombide yer alan

**24 C.S.I. - 24 R.S.I.**

Boru uzunluğu ø 80 [m]	Baca gazı flanşı (F)	Her dirsek için yük kaybı (m)	
		45°	90°
2+2	Ø 42		
>2+2 ÷ 6+6	Ø 44 (**)	1,2	1,7
>6+6 ÷ 16+16	Kurulu değil		

(\*\*) kombide yer alan

**3.6 Isıtma sistemini doldurma (şekil 13)**

Hidrolik bağlantıları yapıldıktan sonra, ısıtma sistemini doldurun. Bu işlem, bu talimatları uygulayarak soğuk sistemle yapılmalıdır:

- Otomatik tahliye supabını iki ya da üç kez çevirerek döndürün (I)
- Soğuk su giriş musluğunun açık olduğundan emin olun
- Doldurma musluğunu (RSI için harici.- CSI için L şekil 13 ), su basıncı göstergesindeki değer 1 ila 1,5 bar olana kadar açın.

Dolum tamamlandığında, doldurma musluğunu kapatın.

Kombi etkin bir hava ayırıcıya sahip olduğundan hiç bir manuel müdahaleye ihtiyaç göstermez. Brülör yalnızca hava tahliye aşaması bittiğinde açılır.

**3.7 Isıtma sistemini boşaltma**

Sistemi boşaltmak için aşağıdaki şekilde ilerleyin:

- Kombiyi kapatın
- Kombi çıkış musluğunu (M) gevşetin
- Sistemi en düşük dereceye kadar tahliye edin.

**3.8 Şebeke sıcak suyunu boşaltma (sadece C.S.I. modeli için)**

Donma riski olduğunda, şebeke sıcak su sistemi aşağıdaki şekilde boşaltılmalıdır:

- Şu şebekesi ana musluğunu kapayın
- Tüm sıcak ve soğuk su musluklarını açın
- En düşük dereceye kadar tahliye edin.

**UYARI**

Emniyet valfinin (N) tahliyesi durumunda, bunun uygun bir toplama sistemine bağlı olması gerekir. Üretici, emniyet valfi işleminden doğabilecek olası hasarlardan sorumlu değildir.

**B22P/B52P Emme iç mekan ve tahliye dış mekan**

**C12-C12x** Konsantrik duvar çıkışı ile tahliye. Borular kombine bağımsız olabilir, ancak çıkışları konsantrik veya benzer rüzgar koşullarına tabi olarak birbirine yeterince yakın olmalıdır (50 cm içerisinde)

**C22** Ortak duman borusunda konsantrik çıkış yoluyla tahliye (emme ve tahliye aynı buruda)

**C32-C32x** Konsantrik çatı çıkışı ile tahliye. Çıkışlar C13' teki gibi

**C42-C42x** Ortak ayrı duman borularında ancak benzer rüzgar koşullarına tabi olarak emiş ve tahliye

**C52-C52x** Duvar veya çatıda ve farklı basınçları olan yerlerde ayrı tahliye ve emiş hatları. Emme ve tahliye hatları asla karşıt duvarlara yerleştirilmemelidir

**C62-C62x** Piyasada olan ve ayrı ayrı onaylanmış borular kullanarak tahliye ve emme hatları (1856/1)

**C82-C82x** Tek veya ortak duman boru ve duvar emme hattı ile tahliye

**C92-C92x** Çatıda tahliye (C33 benzeri) ve tek bir mevcut duman borusundan hava emiş

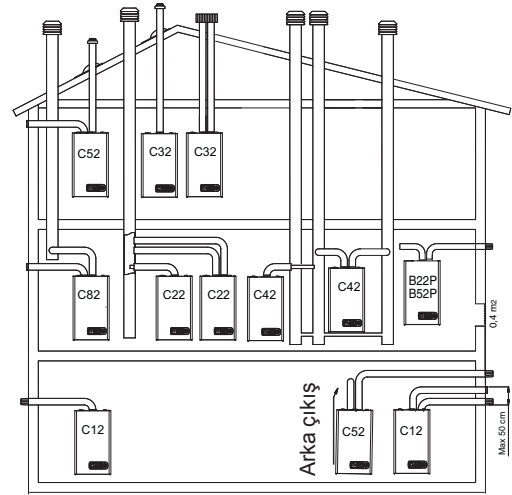

## 4 ATEŞLEME VE İŞLEYİŞ

### 4.1 Ön kontroller

**İlk ateşleme yetkili bir Beretta Teknik Destek Servisinin uzman personeli tarafından gerçekleştirilir.**

Kombiyi devreye almadan önce:

- besleme ağları verilerinin (elektrik, su, gaz) etiket verileriyle uyduğuna
- kombiden ayrılan borunun ısı yalıtım kılıfıyla kaplı olduğunu
- baca gazı çıkarma ve hava emiş borularının düzgün çalıştığını
- kombi mobilya içine veya arasına yerleştirilmişse, düzenli bakım için gereken şartların garanti edildiğini
- yakıt adüksiyon sistemi mührünü
- yakıt kapasitesinin kombinin talep ettiği değerlere denk düşüğünü
- yakıt besleme sisteminin kombi için gereken kapasiteyi haiz olduğunu ve mevcut düzenlemelerin öngördüğü tüm emniyet -kontrol cihazlarına sahip bulunduğunu kontrol ediniz.

### 4.2 Cihaz ateşleme



Kombiyi başlatmak için, aşağıdaki işlemlerin gerçekleştirilmesi gereklidir:

- Kombiye çalıştırın
- Yakıt akışını sağlamak için sistemdeki gaz musluğunu açın
- Mod seçiciyi istenilen konuma getirin (1 - şekil 1a):

#### Ciao S C.S.I.:

**Yaz modu:** seçiciyi yaz sembolüne  (şekil. 2a) getirerek sadece klasik şebeke sıcak su işlevi etkinleştirilir. Sıcak su kullanım ihtiyacı halinde dijital göstergede sıcak su sistem ısısı, sıcak su kaynağını belirten simge ve alev simgesi görünür

**Kış modu:** Mod seçiciyi + ve - işaretli alan içinde ayarlamak suretiyle (Şekil 2b) kombi, sıcak su ve ısıtma sağlar. Isı talebi olduğunda kombi devreye alınır ve dijital ekranda su sıcaklığı, ısıtma ve alev simgesi (Şekil 3a) görülür. Şebeke sıcak su talebi durumunda yine kombi devreye alınır ve dijital göstergede (Şekil 4a) sıcak su sistem ısısı, sıcak su kaynağını belirten simge ve alev simgesi görünür

**Ön ısıtma (daha hızlı sıcak su):** Ön ısıtma fonksiyonunu etkinleştirmek için, sıcak su ısı ayar düğmesini (2-Şekil 1a.)  sembolüne (Şekil 5a) çevirin. Bu fonksiyon, ihtiyaç halinde bekleme sürelerini azaltmak için, şebeke sıcak su eşanjöründeki suyu sıcak tutar. Ön ısıtma fonksiyonu etkin olduğunda, istek uyarınca ekranda ısıtma suyu veya şebeke sıcak suyu servis sıcaklığı görülür. Ön ısıtma talebini müteakip brülör ateşlemesi esnasında, ekranda **P** sembolü görülür (şekil. 5b). Ön ısıtma fonksiyonunu devre dışı bırakmak için, şebeke sıcak su ısı ayar düğmesini yeniden  Q sembolüne getirin. Şebeke sıcak su ısı ayar düğmesini tekrar istenen konuma çevirin. Kombi ve fonksiyon seçici (1 şekil 1a) KAPALI  durumunda iken bu fonksiyon aktive edilemez.

#### Ciao S R.S.I.:

**Yaz modu (sadece harici su tankı bağlı iken):** Seçiciyi yaz sembolüne  getirince (şekil. 2a) sadece klasik şebeke sıcak su işlevi etkinleştirilir ve kombi harici depolama tankı üzerinde belirtilen sıcaklıkta su temin eder. Sıcak su kullanım ihtiyacı halinde dijital göstergede sıcak su sistem ısısı, sıcak su kaynağını belirten simge ve alev simgesi görünür

**Kış modu:** Mod seçiciyi + ve - işaretli alan içinde ayarlayarak (şekil. 2b), kombi ısıtma için sıcak su ve - eğer harici depolama tankına bağlı ise - şebeke sıcak suyu temin eder. Isı talebi olduğunda kombi devreye alınır ve dijital ekranda su sıcaklığı, ısıtma ve alev simgesi (Şekil 3a) görülür. Şebeke sıcak suyu talep edildiğinde kombi devreye alınır ve dijital göstergede (Şekil 4a) sıcak su sistem ısısı, sıcak su kaynağını gösteren simge ve alev simgesi belirir.

Ortam termostatını gerekli sıcaklığa (~20°C) ayarlayın

### Ciao S C.S.I.: Şebeke sıcak su ısını ayarlama

Şebeke su sıcaklığını ayarlamak için (banyo, duş, mutfak vs)  sembollü düğmeyi (şekil. 2b) + ve - işaretli alan içerisinde çevirin. Isı talebini müteakip, brülör devreye girene kadar kombi standby durumunda kalır ve dijital göstergede sıcak su sistem ısısı, sıcak su kaynağını gösteren simge ve alev simgesi görünür

Kombi ayarlanan sıcaklığa ulaşana kadar çalışacak ve ardından tekrar standby durumuna geçecektir. Kumanda panelindeki  sembolünün yanında bulunan kırmızı gösterge ışığı yanarsa, bu kombinin geçici olarak durduğunu gösterir (ışık sinyalleri ve arızalar hakkındaki bölüme bakınız). Dijital ekran algılanan arıza kodunu gösterir (şekil. 6a).

### Ciao S R.S.I.: Şebeke sıcak su ısını ayarlama

**DURUM A** sadece ısıtma - ayarlama gerekmez

**DURUM B** sadece ısıtma + termostatlı harici depolama tankı - ayarlama gerekmez.

**DURUM C** sadece ısıtma + problu harici depolama tankı -depolama tankındaki şebeke sıcak su ısını ayarlamak için sembollü düğmeyi saat yönünde çevirerek su sıcaklığını arttırın ve saat yönünün tersine çevirerek azaltın.

Isı talebini müteakip, brülör devreye girene kadar kombi standby durumunda kalır ve dijital göstergede sıcak su sistem ısısı, sıcak su kaynağını gösteren simge ve alev simgesi görünür

Kombi ayarlanan sıcaklığa ulaşana kadar çalışacak ve ardından tekrar standby durumuna geçecektir. Kumanda panelindeki  sembolünün yanında bulunan kırmızı gösterge ışığı yanarsa, bu kombinin geçici olarak durduğunu gösterir (ışık sinyalleri ve arızalar hakkındaki bölüme bakınız). Dijital ekran algılanan arıza kodunu gösterir (şekil. 6a)

### Ciao S C.S.I. - Ciao S R.S.I.: Çevre Otomatik Ayarlama Sistem Fonksiyonu (S.A.R.A.) şekil. 7a

Isıtma suyu sıcaklık seçicisini 55 ila 65°C arasındaki AUTO ile işaretlenmiş bölgeye ayarlamak suretiyle S.A.R.A. kendinden ayarlama sistemi etkin hale gelir: kombi, ortam termostatının kapanma sinyaline göre servis sıcaklığını değiştirir. Isıtma suyu sıcaklık seçicisiyle ayarlanan sıcaklığa ulaşıldığında, 20 dakikalık bir sayım başlar. Bu süre içerisinde ortam termostatı halen ısı talep ederse, ayarlanan sıcaklık değeri otomatik olarak 5 °C kadar artar.

Yeni değere ulaşıldığında diğer 20 dakikalık sayım başlar.

Bu süre içerisinde ortam termostatı halen ısı talep ederse, ayarlanan sıcaklık değeri otomatik olarak 5 °C kadar artar.

Bu yeni sıcaklık değeri, S.A.R.A fonksiyonunun +10 °C artışının ve ısıtma suyu sıcaklık seçicisi ile manuel olarak ayarlanan sıcaklığın neticesidir.

İkinci devrin ardından sıcaklık değeri, ortam termostat değeri karşılına kadar +10°C'de muhafaza edilir.

### 4.3 Kapatma

#### Geçici kapatma

Kısa süreli bulunmama durumlarında mod seçiciyi (1 - şekil 1a)  (KAPALI) konumuna ayarlayın.

Böylelikle (elektrik ve yakıt beslemeyi etkin halde bırakarak) kombi aşağıdaki sistemlerle korunmuş olacaktır:

- **Anti-frost cihazı:** Kombi içerisindeki su sıcaklığı 5°C'nin altına düşerse, sirkülör ve gerekliyse brülör, su sıcaklığını yeniden güvenlik değerlerine (35°C) getirmek üzere minimum çıkış seviyesinde aktive edilir. Anti-frost döngüsü süresince dijital ekranda  sembolü görülür.

- **Sirkülör anti-bloklama fonksiyonu:** işletim döngüsü her 24 saatte devreye girer.

- **DHW Antifriz (sadece problu harici depolama tankına bağlandığında):** depolama tankı ölçüm ucu ile ölçülen sıcaklık 5° C'nin altına düşerse fonksiyon aktif hale gelir. Bu evrede, brülörün minimum güçte ateşlemesiyle sıcaklık 55° C'ye ulaşana kadar süren bir ısı talebi hasil olur. Anti-frost döngüsü müddetince dijital ekranda  sembolü görülür.

















**Uzun süreli kapama**

Uzunca bir süre çalıştırmayacaksanız, mod seçiciyi (1 - şekil 1a)  (KAPALI) konumuna ayarlayın.



Ardından sistemde mevcut olan gaz musluğunu kapatın. Bu durumda anti-frost cihazı devre dışı kalacaktır: donma riskine karşı sistemi boşaltın.

**4.4 Işık sinyalleri ve arızalar**

Kombinin dijital göstergesinden takip edilebilecek çalışma durumu aşağıdaki tablodaki durumları ifade eder.

KOMBİ DURUMU	GÖSTERGE
Beklemede	-
OFF	KAPALI
ACF modülü kilitleme alarmı	A01 
ACF elektrik arızası alarmı	A01 
Limit termostatı alarmı	A02 
Hava presostat alarmı	A03 
H2O presostat alarmı	A04 
NTC şebeke arızası (CSI ve RSI sadece sondalı harici kazanlılar)	A06 
NTC ısıtma arızası	A07 
Parazit alev	A11 
Isıtma min. ve maks. elektrik ayarı	ADJ 
Açılmayı beklemede geçici	88°C yanıp sönen
Hava presostatı müdahalesi	 yanıp sönen
H2O presostatı müdahalesi	 yanıp sönen
Ön Isıtma Fonksiyonu Aktif (sadece C.S.I.)	P
Ön Isıtma Isı Talebi (sadece C.S.I.)	P yanıp sönen
Dışarıda sonda var	
Şebeke su ısıtma talebi	60°C 
Isıtma ısı talebi	80°C 
Anti-frost ısı talebi	
Alev var	

**Çalışmayı eski haline getirme (alarmı devre dışı bırakma):****Arıza A 01-02-03**

Fonksiyon seçiciyi  (KAPALI) konuma getirin, 5-6 saniye bekleyin, ardından istenen konuma  (yaz modu) veya  (kış modu) ayarlayın.



Sıfırlama girişimi kombiyi yeniden aktif hale getirmiyorsa, Teknik Yardım Servisi ile irtibata geçiniz.

**Arıza A 04**

Arıza koduna ek olarak, dijital ekran  sembolünü gösterir.

Su göstergesindeki basınç değerini kontrol edin:

0,3 bar'dan az ise, fonksiyon seçiciyi  (KAPALI) konuma getirin ve basınç değeri 1 ila 1,5 bar arasında bir seviyeye ulaşana kadar doldurma musluğunu (C.S.I. için L şekil 13 - R.S.I için harici) ayarlayın.

Daha sonra mod seçiciyi istenen konuma  (yaz) veya  (kış) getirin.

Kombinin bir tahliye döngüsü ortalama 2 dakika sürecektir.

Basınç düşüşleri sık vuku buluyorsa, Teknik Yardım Servisinin müdahalesini talep edin.

**Arıza A 06 (sadece C.S.I.)**

Kombi normal çalışmakta ancak yaklaşık 50°C civarında olan sabit şebeke sıcak su ısısını güvenli bir biçimde koruyamamaktadır. Teknik Yardım Merkezi ile irtibata geçiniz.

**Arıza A 07**

Teknik Yardım Merkezi ile irtibata geçiniz.

**4.5 Ayarlamalar**

Kombi önceden üretici tarafından ayarlanmıştır.

Olağanüstü bir bakım, gaz valfi değişimi veya gaz dönüşümünden sonra tekrar ayarlamak gerekirse, aşağıdaki prosedürü takip edin.

 **Maksimum çıkış ayarlaması vasıflı personel tarafından özel olarak sıralı şekilde yapılmalıdır.**

- Sabitleme vidasını sökerek gövdeyi çıkarın (şekil. 6)
- Basınç ölçere bağlı olan ve gaz vanasını gösteren basınç testi vidasını iki turda sökün
- Hava dağıtım kutusu dengeleme girişinin bağlantısını sökün

**4.5.1 Ciao S C.S.I.: Maksimum güç ve minimum şebeke sıcak su ayarı**

- Sıcak su musluğunu tamamen açın
- kontrol panelinde:
- Mod seçiciyi  (yaz) ayarlayın (şekil. 2a)
- Şebeke sıcak su ısısı seçicisini maksimuma getirin (şekil. 8a)
- Sistem ana anahtarını açık konuma getirerek kombiyi çalıştırın
- Basınç ölçerdeki basıncın sabit olduğunu kontrol edin; veya modülátöre seri bağlı bir miliampermetre ile modülátörün maksimum elverişli akımı sağladığından emin olun (G20 için 120 mA ve LPG için 165 mA).
- Tornavida kullanarak dikkatli bir şekilde ayar vidalarının koruma kapağını çıkarın (şekil. 15)
- "Teknik veriler" tablosunda belirtilen değeri elde etmek için çatal anahtar CH10 ile maksimum çıkış ayar somununu kullanın
- Modülátör soket bağlantısını kesin
- Basınç göstergesindeki basınç minimum değerinde sabitlenene kadar bekleyin
- Dahili şafta basmamaya dikkat ederek alyan anahtarı kullanmak suretiyle şebeke sıcak su minimum ısı ayarı için kırmızı ayarlama vidasını döndürüp, basınç ölçer "Teknik veri" tablosunda belirtilen değeri okuyana kadar kalibre edin
- Modülátör soket bağlantısını tekrar bağlayın
- Şebeke sıcak su musluğunu kapayın
- Ayar vidasının koruma kapağını dikkatlice yerleştirin.

**Ciao S R.S.I.: Maksimum ve minimum güç ayarı**

- Fonksiyon seçiciyi  (kış) (şekil. 2b) ayarlayın
- Gövdeyi sökün ve karta erişin
- JP1 ve JP2 bağlantı kablolarını takın
- Tornavidayı saat yönünde döndürerek P2 düzenleyiciyi maksimum değere getirin
- Ana anahtarı açık konuma getirerek kombiyi çalıştırın
- Basınç ölçerdeki basıncın sabit olduğunu kontrol edin; veya modülátöre seri bağlı bir miliampermetre ile modülátörün maksimum elverişli akımı sağladığından emin olun (G20 için 120 mA ve LPG için 165 mA)
- Tornavida kullanarak dikkatli bir şekilde ayar vidalarının koruma kapağını çıkarın
- Çatal anahtar CH10 ile "Teknik veriler" tablosunda belirtilen değeri elde etmek için maksimum çıkış ayar somunu kullanın
- Modülátör soket bağlantısını kesin
- Basınç göstergesindeki basınç minimum değerinde sabitlenene kadar bekleyin
- Dahili şafta basmamaya dikkat ederek alyan anahtarı kullanmak suretiyle şebeke sıcak su minimum ısı ayarı için kırmızı ayarlama vidasını döndürüp, basınç ölçer "Teknik veri" tablosunda belirtilen değeri okuyana kadar kalibre edin
- Modülátör soket bağlantısını tekrar bağlayın
- Kombinin güç kaynağı bağlantısını kesin
- JP1 ve JP2 bağlantı kablolarını sökün
- Ayar vidasının koruma kapağını dikkatlice yerleştirin.

**4.5.2 Minimum ve maksimum ısı elektrik ayarı**

 "Elektrik ayar" fonksiyonu, sadece (JP1) bağlantı kablosu ile etkin veya etkisiz hale getirilebilir (şekil. 16).

Gösterge ekranında ayarlama işleminin sürdüğünü ifade eden ADJ  simgesi görünecektir.

Fonksiyon aşağıdaki şekilde etkin hale geçebilir:

- Diğer muhtemel çalışma taleplerinden bağımsız olarak, mod seçici kış konumunda iken takılı JP1 bağlantı kablosu ile karta güç vererek.
- Herhangi bir ısı talebi sürmüyorken ve mod seçici kış konumunda iken JP1 bağlantı kablosunu takarak.

⚠ Bu fonksiyonun etkin hale getirilmesiyle brülör ısıtma talebine benzer bir şekilde ateşlenir.

Kalibrasyon işlemini gerçekleştirmek için şu şekilde ilerleyiniz:

- Kombiyi kapatın
- Gövdeyi çıkarın ve karta erişin
- Kontrol paneli üzerindeki düğmelerin minimum ve maksimum ısı ayar fonksiyonlarında etkin hale gelmesi için JP1 (şekil 16) bağlantı kablosunu takın.
- Mod seçicinin kış konumunda olduğundan emin olun (bakınız bölüm 4.2).
- Kombiye çalıştırın

#### ⚠ (230 Volt) gerilimde elektrik kartı

- Çoklu gaz tablosunda belirtilen minimum ısıtma değerine ulaşıncaya kadar ısıtma su sıcaklığı düğmesini **B** (şekil 17) çevirin
- JP2 (şekil. 16) bağlantı kablosunu takın
- Çoklu gaz tablosunda belirtilen maksimum ısıtma değerine ulaşıncaya kadar ısıtma su sıcaklığı düğmesini **C** (şekil 17) çevirin
- Maksimum ısıtma değerini muhafaza etmek için JP2 bağlantı kablosunu sökün
- **Minimum ısıtma değerini muhafaza etmek ve kalibrasyon prosedüründen çıkmak için JP1 bağlantı kablosunu sökün**
- Dengeleme girişini hava dağıtım kutusuna tekrar bağlayın

Basınç ölçer bağlantısını kesin ve basınç test noktası vidasını yeniden sıkın.

⚠ Belirlenen değerleri kaybetmeden kalibrasyon fonksiyonunu tamamlamak için aşağıdaki şekilde ilerleyiniz:

- a) Mod seçiciyi **⏻** (KAPALI) konuma getiriniz
- b) Güç besleme gerilimini sökün
- c) JP1/JP2 sökün

⚠ Kalibrasyon fonksiyonu, aktif hale gelmesinden 15 dakika sonra, minimum ve maksimum değerleri kaydetmeden otomatik olarak sonlanır.

⚠ Kesin durma veya kilitleme halinde fonksiyon otomatik olarak sonlanır.

Yine bu durumda da fonksiyon neticesi değerlerin kaydedilmesini SAĞLAMAZ.

#### Not

Sadece maksimum ısıtmaya kalibre etmek için, (maksimumu kaydetmek üzere) JP2 bağlantı kablosunu sökmek ve minimumu kaydetmeden, mod seçiciyi **⏻** (KAPALI) konuma getirmeden veya kombiden voltajı kesmeden fonksiyondan çıkmak mümkündür.

⚠ Gaz valfinin her ayarlanmasında yapılan muamele sonrası damgalama cilası ile mühürlenir.

Ayarlama tamamlandığında:

- Ortam termostatı ile ayarlanan sıcaklığı istenen sıcaklığa getirin
- Isıtma su sıcaklığı seçicisini istenen konuma ayarlayın
- Alet panelini kapayın
- Gövdeyi tekrar yerine çekin.

#### 4.6 Gaz dönüşüm faaliyeti

Bir gaz türünden başka bir gaz türüne dönüşüm kombi kurulduğunda kolaylıkla gerçekleştirilebilir.

Ürün etiketine göre kombi, metan gazıyla (G20) çalışmak üzere tasarlanmıştır.

Talep üzerine temin edilebilecek uygun kiti kullanarak kombileri bir gaz türünden diğerine dönüştürmek mümkündür:

- Metan dönüşüm kiti
- LPG dönüşüm kiti

Demonte etmek için aşağıdaki talimatları uygulayınız:

- Kombiden güç kaynağını sökün ve gaz musluğunu kapayın
- Sırasıyla sökün: gövde, hava dağıtım kutusu kapağı ve yanma odası kapağı (şekil. 19)
- Buji kablosu bağlantısını kesin
- Hava dağıtım kutusundaki yerinden alt kablo kovanını dışarı kaydırın
- Brülör sabitleme vidalarını sökün ve bujiye bağlı olan ikincisini ve ilgili kabloları sökün
- Soket veya çatal anahtar kullanarak, ağızlık ve rondelaları sökün ve kittekileri yenileriyle değiştirin.

⚠ **Manifoldlarda rondela bulunmaması durumunda da kitteki rondelaları kullanın ve monte edin.**

- Brülörü tekrar yanma odasına yerleştirin ve gaz manifolduna sabitleyen vidaları sıkın
- Buji kablosu ile kablo kovanını hava dağıtım kutusundaki yerine yerleştirin
- Buji kablo bağlantısını yapın
- Yanma odası kapağını ve hava dağıtım kutusunun kapağını takın
- Kontrol panelini kombinin ön kısmına doğru çevirin
- Kart kapağını açın
- Kontrol kartında (şekil. 16):
  - Dönüşüm metan gazından LPG'ye ise, bağlantı kablosunu JP3 konumuna sokun
  - Dönüşüm LPG'den metan gazına ise, bağlantı kablosunu JP3 konumundan çıkarın
- Daha önce sökülmüş bileşenleri yeniden yerlerine takın
- Kombiye yeniden gerilim sağlayın ve (kombi çalışırken, gaz besleme devre bağlantıları mühürünün doğruluğunu kontrol edin) gaz musluğunu açın.

⚠ **Dönüşüm vasıflı personel tarafından yapılmalıdır.**

⚠ **Dönüşümden sonra belirtilen bölümdeki talimatları izleyerek kombiyi tekrar ayarlayın ve kit içerisinde bulunan yeni tanımlama etiketini uygulayın.**

## 5 BAKIM

Ürünün özelliklerini ve verimliliğini muhafaza etmesini sağlamak ve mevcut düzenlemelerin yönergelerine uymak için düzenli aralıklarla cihazların sistematik kontrollerinin yapılması gereklidir.

Denetim sıklığı, kurulum ve kullanım koşullarına bağlıdır, bu yüzden de Teknik Yardım Servisinin yetkili personeli tarafından yıllık tam bakım yapılmalıdır.

Baca egzoz bağlantıları, cihazları ve buna bağlı aksesuarların yanındaki yapının bakımını yürütmek için cihazı kapatın. Müdahaleler bittiğinde yetkili teknisyen, borular ve cihazların doğru çalıştığını kontrol etmelidir.

**ÖNEMLİ:** Cihazda herhangi bir temizlik veya bakım işlemi gerçekleştirilmeden önce, kombi üzerine yerleştirilmiş musluğu döndürerek güç beslemesini kesin ve gazı kapatın; bunun için cihaz ve sistem anahtarını kullanın.

Cihazı ya da parçalarını yanıcı maddelerle temizlemeyin (örneğin, benzin, alkol, vb.).

Panelleri, boyalı ve plastik kısımları boya tineriyle temizlemeyin. Panel temizliği sadece sabunlu su ile yapılmalıdır.

#### 5.1 Yanma parametrelerini kontrol etme

**Ciao S C.S.I.:**

Yanma analizini yapmak için aşağıdaki şekilde hareket edin:

- Sıcak su musluğunu maksimum çıkışa kadar açın
- Mod seçiciyi yaza **☀** ve şebeke sıcak su seçicisini maksimum değere getirin (şekil 8a).
- Yanma analiz giriş kapağı vidasını sökün (şekil 18) ve ölçüm uçlarını takın
- Kombiye çalıştırın

**Ciao S R.S.I.:**

- Kombiyi kapatın
- Fonksiyon seçiciyi kış moduna getirin
- Gövdeyi sökün ve karta erişin
- JP1 ve JP2 bağlantı kablolarını takın
- kontrol paneli üzerindeki fişi sökmek için tornavida kullanın
- Tornavidayı saat yönünde döndürerek P2 düzenleyiciyi maksimum değere getirin
- Yanma analiz giriş kapağı vidasını sökün (şekil 18) ve ölçüm uçlarını takın
- Kombiyi çalıştırın

Cihaz maksimum çıkışta çalışır ve tutuşmayı kontrol etmesi mümkündür.

Analiz tamamlandıktan sonra:

- Sıcak su musluğunu kapatın
- Ölçüm ucunu analiz cihazından sökün ve daha önce sökülen vidayı dikkatlice sabitleyerek yanma analiz girişini kapayın.

## KULLANICI

## 1A GENEL UYARILAR

Kullanım kılavuzu ürünün ayrılmaz bir parçasıdır ve bu nedenle dikkatle saklanmalı ve cihaza eşlik etmelidir; kılavuzun kaybolması veya hasar görmesi durumunda, başka bir kopyası Teknik Yardım Servisinden talep edilmelidir.

- ⚠️ Kombi kurulumu ve diğer yardım ve bakım işlemleri yürürlükteki yerel ve ulusal yönetmeliklere göre, vasıflı personel tarafından yapılmalıdır.
- ⚠️ Kurulum için uzman personelle irtibata geçmeniz önerilir.
- ⚠️ Bu kombi sadece maksadına uygun olarak kullanılmalıdır. Üretici yanlış kullanım ile kurulum, ayarlama ve bakımdan doğabilecek mülke hasar ya da kişilere veya hayvanlara yönelik yaralanmalarda, sözleşmede yer alan yahut almayan her tür yükümlülüğü peşinen reddeder.
- ⚠️ Güvenlik ve otomatik ayarlama cihazları üretici veya tedarikçi tarafından, sistem yaşam döngüsü boyunca modifiye edilmemelidir.
- ⚠️ Bu cihaz sıcak su üretir, bu nedenle, performansı ve çıkışı ile uyumlu bir ısıtma sistemine ve / veya sıcak su şebekesine bağlanmalıdır.
- ⚠️ Su sızıntısı durumunda suyu kapatın ve derhal Teknik Yardım Servisiyle irtibata geçin.
- ⚠️ Uzunca bir süre kullanmayacaksanız, gaz beslemesini ve elektrik besleme ana anahtarını kapayın. Donma riskine karşı kombiyi boşaltın.
- ⚠️ Zaman zaman hidrolik sistem çalışma basıncının 1 barın altına düşüp düşmediğini kontrol edin.
- ⚠️ Hata ve/veya arıza halinde cihazı devre dışı bırakın ve doğrudan müdahale veya tamir etmeye kalkışmayın.
- ⚠️ Cihaz bakımı en az yılda bir kez yapılmalıdır: Teknik Destek Servisi ile programlanması zaman ve para israfını önleyecektir.

Kombi kullanımını bazı temel güvenlik kurallarının gözetilmesini gerektirir:

- Cihazı kullanım amacı dışında kullanmayın.
- Yalınayaksanız veya vücudunuzun bir kısmı ıslak ya da nemli ise kombiye dokunmayın.
- Kurulum odasındaki emme ve dağıtım ızgaraları ile havalandırma deliklerini hiçbir koşulda bez, kağıt ya da benzeri diğer malzemelerle kapatmayın.
- Gaz kokusu varsa, kıvılcıma sebebiyet verebilecek elektrik anahtarları, telefon ya da başka herhangi bir nesneyi aktive etmeyin. Kapı ve pencereleri açarak odayı havalandırın ve merkezi gaz musluğunu kapatın.
- Kombi içerisine hiçbir şey yerleştirmeyin.
- Cihazın ana güç kaynağı bağlantısı kesilmemişse herhangi bir temizlik işlemi yapmayın.
- Jeneratörün kurulu olduğu odanın havalandırma deliklerini kapatmayın veya azaltmayın.
- Kurulum odasında konteyner ve yanıcı ürünler bırakmayın.
- Hata ve/veya arıza durumunda cihazı tamir etmeye kalkışmayın.
- Elektrik kablolarını çekmek veya döndürmek tehlikelidir.
- Çocuklar ya da beceri sahibi olmayanlar cihazı kullanmamalıdır.
- Mühürlü elemanlara müdahale etmeyin.

Daha iyi bir kullanım için şunları hatırla tutunuz:

- Sabunlu suyla periyodik dış temizlik sadece estetik yönü geliştirmelele kalmaz aynı zamanda cihaz yaşam döngüsünü uzatarak, panelleri korozyondan da korur;
- Duvara monte edilen kombi asma mobilya içinde ise, havalandırma ve bakım için en az 5 cm boşluk bırakın;
- Bir ortam termostatı kurulumu, ısı ve enerji tasarrufuyla birlikte çok daha konforlu ve rasyonel bir kullanım sağlayacaktır; ayrıca gün ya da hafta boyunca kapatmayı ve ateşlemeyi yönetmek üzere kombi bir programlama saatine de bağlanabilir.

## 2A ATEŞLEME

İlk ateşleme yetkili bir Teknik Destek Servisinin uzman personeli tarafından gerçekleştirilir. Ayrıca cihazı hizmete hazır hale getirmek için de aşağıdaki işlemler dikkatli bir şekilde yapılmalıdır.



Kombiyi başlatmak için, aşağıdaki işlemlerin gerçekleştirilmesi gereklidir:

- Kombiyi çalıştırın
- Yakıt akışını sağlamak için sistemdeki gaz musluğunu açın
- Mod seçiciyi istenilen konuma getirin (1 - şekil 1a):

**Ciao S C.S.I.:**

**Yaz modu:** seçiciyi yaz sembolüne  (şekil. 2a) getirerek sadece klasik şebeke sıcak su işlevi etkinleştirilir. Sıcak su kullanım ihtiyacı halinde dijital göstergede sıcak su sistem ısısı, sıcak su kaynağını belirten simge ve alev simgesi görünür

**Kış modu:** Mod seçiciyi + ve - işaretli alan içinde ayarlamak suretiyle (Şekil 2b) kombi, sıcak su ve ısıtma sağlar. Isı talebi olduğunda kombi devreye alınır ve dijital ekranda su sıcaklığı, ısıtma ve alev simgesi (Şekil 3a) görülür. Şebeke sıcak su talebi durumunda yine kombi devreye alınır ve dijital göstergede (Şekil 4a) sıcak su sistem ısısı, sıcak su kaynağını belirten simge ve alev simgesi görünür

**Ön ısıtma** (daha hızlı sıcak su): Ön ısıtma fonksiyonu etkinleştirmek için, sıcak su ısı ayar düğmesini (2-Şekil 1a.)  sembolüne (Şekil 5a) döndürün. Bu fonksiyon, ihtiyaç halinde bekleme sürelerini azaltmak için, şebeke sıcak su eşanjöründeki suyu sıcak tutar. Ön ısıtma fonksiyonu etkin olduğunda, istek uyarınca ekranda ısıtma suyu veya şebeke sıcak suyu servis sıcaklığı görülür. Ön ısıtma talebini müteakip brülör ateşlemesi esnasında, ekranda **P** sembolü görülür (şekil. 5b). Ön ısıtma fonksiyonunu devre dışı bırakmak için, şebeke sıcak su ısı ayar düğmesini yeniden  sembolüne getirin. Şebeke sıcak su ısı ayar düğmesini tekrar istenen konuma çevirin. Kombi ve fonksiyon seçici (1 şekil 1a) **KAPALI**  durumunda iken bu fonksiyon aktive edilemez.

**Ciao S R.S.I.:**

**Yaz modu (sadece harici su tankı bağlı iken):** Seçiciyi yaz sembolüne  getirince (şekil. 2a) sadece klasik şebeke sıcak su işlevi etkinleştirilir ve kombi harici depolama tankı üzerinde belirtilen sıcaklıkta su temin eder. Sıcak su kullanım ihtiyacı halinde dijital göstergede sıcak su sistem ısısı, sıcak su kaynağını belirten simge ve alev simgesi görünür

**Kış modu:** Mod seçiciyi + ve - işaretli alan içinde ayarlayarak (şekil. 2b), kombi ısıtma için sıcak su ve - eğer harici depolama tankına bağlı ise - şebeke sıcak suyu temin eder. Isı talebi olduğunda kombi devreye alınır ve dijital ekranda su sıcaklığı, ısıtma ve alev simgesi (Şekil 3a) görülür. Şebeke sıcak suyu talep edildiğinde kombi devreye alınır ve dijital göstergede (Şekil 4a) sıcak su sistem ısısı, sıcak su kaynağını gösteren simge ve alev simgesi belirir.

Ortam termostatını gerekli sıcaklığa (~20°C) ayarlayın

**Ciao S C.S.I.: Şebeke sıcak su ısını ayarlama**

Şebeke su sıcaklığını ayarlamak için (banyo, duş, mutfak vs)  sembolü düğmeyi (şekil. 2b) + ve - işaretli alan içerisinde çevirin. Isı talebini müteakip, brülör devreye girene kadar kombi standby durumunda kalır ve dijital göstergede sıcak su sistem ısısı, sıcak su kaynağını gösteren simge ve alev simgesi görünür

Kombi ayarlanan sıcaklığa ulaşana kadar çalışacak ve ardından tekrar standby durumuna geçecektir. Kumanda panelindeki  sembolünün yanında bulunan kırmızı gösterge ışığı yanarsa, bu kombinin geçici olarak durduğunu gösterir (ışık sinyalleri ve arızalar hakkındaki bölüme bakınız). Dijital ekran algılanan arıza kodunu gösterir (şekil. 6a).

**Ciao S R.S.I.: Şebeke sıcak su ısını ayarlama**

**DURUM A** sadece ısıtma - ayarlama gerekmez  
**DURUM B** sadece ısıtma + termostatlı harici depolama tankı - ayarlama gerekmez.

**DURUM C** sadece ısıtma + problu harici depolama tankı - depolama tankındaki şebeke sıcak su ısını ayarlamak için sembolü düğmeyi saat yönünde çevirerek su sıcaklığını arttırın ve saat yönünün tersine çevirerek azaltın.

Isı talebini müteakip, brülör devreye girene kadar kombi standby durumunda kalır ve dijital göstergede sıcak su sistem ısısı, sıcak su kaynağını gösteren simge ve alev simgesi görünür. Kombi ayarlanan sıcaklığa ulaşıncaya kadar çalışacak ve ardından tekrar standby durumuna geçecektir. Kumanda panelindeki  sembolünün yanında bulunan kırmızı gösterge ışığı yanarsa, bu kombinin geçici olarak durduğunu gösterir (ışık sinyalleri ve arızalar hakkındaki bölüme bakınız). Dijital ekran algılanan arıza kodunu gösterir (şekil. 6a)

### Ciao S C.S.I. - Ciao S R.S.I.: Çevre Otomatik Ayarlama Sistem Fonksiyonu (S.A.R.A.) şekil. 7a

Isıtma suyu sıcaklık seçicisini 55 ila 65°C arasındaki AUTO ile işaretlenmiş bölgeye ayarlamak suretiyle S.A.R.A. kendinden ayarlama sistemi etkin hale gelir: kombi, ortam termostatının kapanma sinyaline göre servis sıcaklığını değiştirir. Isıtma suyu sıcaklık seçicisiyle ayarlanan sıcaklığa ulaşıldığında, 20 dakikalık bir sayım başlar. Bu süre içerisinde ortam termostatı halen ısı talep ederse, ayarlanan sıcaklık değeri otomatik olarak 5 °C kadar artar.

Yeni değere ulaşıldığında diğer 20 dakikalık sayım başlar.

Bu süre içerisinde ortam termostatı halen ısı talep ederse, ayarlanan sıcaklık değeri otomatik olarak 5 °C kadar artar.

Bu yeni sıcaklık değeri, S.A.R.A fonksiyonunun +10 °C artışının ve ısıtma suyu sıcaklık seçicisi ile manuel olarak ayarlanan sıcaklığın neticesidir.



İkinci devrin ardından sıcaklık değeri, ortam termostat değeri karşılına kadar +10°C'de muhafaza edilir.

### 3A KAPATMA

#### Geçici kapatma

Kısa süreli bulunmama durumlarında mod seçiciyi ( 1 - şekil 1a)  (KAPALI) konumuna ayarlayın.

Böylelikle (elektrik ve yakıt beslemeyi etkin halde bırakarak) kombi aşağıdaki sistemlerle korunmuş olacaktır:

- **Anti-frost cihazı:** Kombi içerisindeki su sıcaklığı 5°C'nin altına düşerse, sirkülatör ve gerekliyse brülör, su sıcaklığını yeniden güvenlik değerlerine (35°C) getirmek üzere minimum çıkış seviyesinde aktive edilir. Anti-frost döngüsü süresince dijital ekranda  sembolü görülür.
- **Sirkülatör anti-bloklama fonksiyonu:** İşletim döngüsü her 24 saatte devreye girer.
- **DHW Antifriz (sadece problu harici depolama tankına bağlı olduğunda):** depolama tankı ölçüm ucu ile ölçülen sıcaklık 5° C'nin altına düşerse fonksiyon aktif hale gelir. Bu evrede, brülörün minimum güçte ateşlemesiyle sıcaklık 55° C'ye ulaşıncaya kadar süren bir ısı talebi hasıl olur. Anti-frost döngüsü müddetince dijital ekranda  sembolü görülür.

#### Uzun süreli kapama

Uzunca bir süre çalıştırmayacaksanız, mod seçiciyi (1 - şekil 1a)  (KAPALI) konumuna ayarlayın.

Ardından sistemde mevcut olan gaz musluğunu kapatın. Bu durumda anti-frost cihazı devre dışı kalacaktır: donma riskine karşı sistemi boşaltın.

### 4A KONTROLLER





















Isıtma sezonunun başında ve zaman zaman kullanım esnasında, hidrometre-termohidrometrenin soğuk sistem basınç değerlerini 0,6 ve 1,5 bar arasında gösterdiğinden emin olun: bu, havanın varlığına bağlı olarak sistem kirlilik seviyelerini önlr. Yetersiz su sirkülasyonu durumunda, kombi kapanacaktır. Hiçbir koşulda, su basıncı 0,5 bar (kırmızı alan) altında olmamalıdır.

Durumun kontrolü için, kombideki su basıncını aşağıdaki gibi yeniden düzenlemek gerekmektedir:

- Mod seçiciyi (2 - şekil. 1 a)  (KAPALI) ayarlayın
- Basınç değeri 1 ila 1,5 bar arasında olana kadar doldurma musluğunu çevirin (CSI için L şekil. 13. - RSI için harici).
- Musluğu dikkatlice kapayın.
- Mod seçiciyi başlangıç konumuna geri getirin.
- Çok sık basınç düşüşü oluyorsa, Teknik Yardım Servisiyle irtibata geçin.



### 5A IŞIK SİNYALLERİ VE ARIZALAR

Kombinin çalışma durumu ve bunun dijital ekran tarafından gösterilişi, aşağıdaki gösterim türlerinde listelenmiştir.

KOMBİ DURUMU	GÖSTERGE
Beklemede	-
OFF	KAPALI
ACF modülü kilitleme alarmı	A01  
ACF elektrik arızası alarmı	A01  
Limit termostatı alarmı	A02 
Hava presostat alarmı	A03 
H2O presostat alarmı	A04  
NTC şebeke sıcak su arızası (CSI ve RSI sadece sondalı harici kazanlılar)	A06 
NTC ısıtma arızası	A07 
Parazit alev	A11 
Isıtma min. ve maks. elektrik ayarı	ADJ 
Açılmayı beklemede geçici	88°C yanıp sönen
Hava presostatı müdahalesi	 yanıp sönen
H2O presostatı müdahalesi	  yanıp sönen
Ön Isıtma Fonksiyonu Aktif (sadece C.S.I.)	P
Ön Isıtma Isı Talebi (sadece C.S.I.)	P yanıp sönen
Dışarıda sonda var	
Şebeke su ısıtma talebi	60°C 
Isıtma ısı talebi	80°C 
Anti-frost ısı talebi	
Alev var	

#### Çalışmayı eski haline getirme (alarmı devre dışı bırakma):

##### Arıza A 01-02-03



Fonksiyon seçiciyi  (KAPALI) konuma getirin, 5-6 saniye bekleyin, ardından istenen konuma  (yaz modu) veya  (kış modu) ayarlayın.

Sıfırlama girişimi kombiyi yeniden aktif hale getirmiyorsa, Teknik Yardım Servisi ile irtibata geçiniz.

##### Arıza A 04

Arıza koduna ek olarak, dijital ekran  sembolünü gösterir.

Su göstergesindeki basınç değerini kontrol edin:

0,3 bar'dan az ise, fonksiyon seçiciyi  (KAPALI) konuma getirin ve basınç değeri 1 ila 1,5 bar arasında bir seviyeye ulaşıncaya kadar doldurma musluğunu (C.S.I. için L şekil 13 - R.S.I için harici) ayarlayın. Daha sonra mod seçiciyi istenen konuma  (yaz) veya  (kış) getirin.

Kombinin bir tahliye döngüsü ortalama 2 dakika sürecektir.

Basınç düşüşleri sık vuku buluyorsa, Teknik Yardım Servisinin müdahalesini talep edin.

##### Arıza A 06 (sadece C.S.I.)

Kombi normal çalışmakta ancak yaklaşık 50°C civarında olan sa-bit şebeke sıcak su ısını güvenli bir biçimde koruyamamaktadır. Teknik Yardım Merkezi ile irtibata geçiniz.

##### Arıza A 07

Teknik Yardım Merkezi ile irtibata geçiniz.

## TEKNİK VERİLER

AÇIKLAMA			CIAO 20 S C.S.I.	CIAO 24 S C.S.I.	CIAO 24 S R.S.I.
Isıtma	Isı girişi	kW	22,20	25,80	25,80
		kcal/sa	19.092	22.188	22.188
	Maksimum ısı çıkışı	kW	20,60	23,94	23,94
		kcal/sa	17.717	20.590	20.590
	Minimum ısı girişi	kW	7,00	8,90	8,90
		kcal/sa	6.020	7.654	7.654
	Minimum ısı çıkışı	kW	5,88	7,61	7,61
		kcal/sa	5.057	6.544	6.544
DHW	Isı girişi	kW	22,20	25,80	-
		kcal/sa	19.092	22.188	-
	Maksimum ısı çıkışı	kW	20,60	23,94	-
		kcal/sa	17.717	20.590	-
	Minimum ısı girişi	kW	7,00	8,90	-
		kcal/sa	6.020	7.654	-
	Minimum ısı çıkışı	kW	5,88	7,61	-
		kcal/sa	5.057	6.544	-
Yararlı verimlilik (Pn maks - Pn min)		%	92,8 - 84,0	92,8 - 85,5	92,8 - 85,5
Verimlilik %30 (47° dönüş)		%	91,9	90,9	90,9
Analiz soketi ile yanma performansı		%	93,2	93,0	93,0
Elektrik gücü		W	100	116	116
Kategori			II2H3+	II2H3+	II2H3+
Gideceği ülke			-	-	-
Güç kaynağı gerilimi		V - Hz	230-50	230-50	230-50
Koruma derecesi		IP	X5D	X5D	X5D
Brülör açıkken bacada basınç düşüşü		%	6,85	6,96	6,96
Brülör kapalı iken bacada basınç düşüşü		%	0,09	0,07	0,07
<b>Isıtma işlemi</b>					
Basınç - maksimum sıcaklık		bar-°C	3 - 90	3 - 90	3 - 90
Standart işleyiş için minimum basınç		bar	0,25 - 0,45	0,25 - 0,45	0,25 - 0,45
Isıtma suyu sıcaklığı seçim alanı		°C	40/80	40/80	40/80
Pompa: uygun maksimum basma sistem kapasitesi için		mbar	300	300	300
Membran genişleme tankı		l	7	8	8
Genişleme tankı ön dolum		bar	1	1	1
<b>DHW işlemi</b>					
Maksimum basınç		bar	6	6	-
Minimum basınç		bar	0,15	0,15	-
25°C de sıcak su miktarı		l/min	11,8	13,7	-
30°C de		l/min	9,8	11,4	-
35°C de		l/min	8,4	9,8	-
DHW minimum çıkış		l/min	2	2	-
DHW sıcaklık seçim alanı		°C	37/60	37/60	-
Akış düzenleyicisi		l/min	8	10	-
<b>Gaz basıncı</b>					
Metan gazı nominal basıncı (G 20)		mbar	20	20	20
LPG sıvı gaz nominal basıncı (G 31)		mbar	28-30/37	28-30/37	28-30/37
<b>Hidrolik bağlantı</b>					
Isıtma giriş - çıkış		Ø	3/4"	3/4"	3/4"
DHW giriş - çıkış		Ø	1/2"	1/2"	-
Su tankı tahliye - çıkış		Ø	-	-	3/4"
Gaz giriş		Ø	3/4"	3/4"	3/4"
<b>Kombi boyutları</b>					
Yükseklik		mm	715	715	715
Genişlik		mm	405	405	405
Gövde derinliği		mm	248	248	248
Kombi ağırlığı		kg	29	31	28
<b>Akış hızı (G20)</b>					
Hava kapasitesi		Nm <sup>3</sup> /sa	36,875	39,613	39,613
Baca gazı kapasitesi		Nm <sup>3</sup> /sa	39,101	42,204	42,204
Baca gazı kütle akışı (maks-min)		gr/s	13,310 - 14,540	14,308 - 16,247	14,308 - 16,247
<b>Akış hızı (G30)</b>					
Hava kapasitesi		Nm <sup>3</sup> /sa	35,328	40,249	40,249
Baca gazı kapasitesi		Nm <sup>3</sup> /sa	36,955	41,008	41,008
Baca gazı kütle akışı (maks-min)		gr/s	13,100 - 14,030	13,985 - 16,429	13,985 - 16,429



AÇIKLAMA		CIAO 20 S C.S.I.	CIAO 24 S C.S.I.	CIAO 24 S R.S.I.
<b>Akış hızı (G31)</b>				
Hava kapasitesi	Nm <sup>3</sup> /sa	36,405	40,454	40,454
Baca gazı kapasitesi	Nm <sup>3</sup> /sa	38,119	41,455	41,455
Baca gazı kütle akışı (maks-min)	gr/s	13,480 - 14,280	14,120 - 16,683	14,120 - 16,683
<b>Fan performansı</b>				
Borular olmaksızın net basış	Pa	43	110	110
<b>Konsantrik baca gazı tahliye boruları</b>				
Çap	mm	60-100	60 - 100	60 - 100
Maksimum uzunluk	m	4,25	4,25	4,25
45 ° / 90 ° dirsek takılması nedeniyle düşüş	m	1 - 1,5	1 - 1,5	1 - 1,5
Duvardaki delik (çap)	mm	105	105	105
<b>Konsantrik baca gazı tahliye boruları</b>				
Çap	mm	80-125	80-125	80-125
Maksimum uzunluk	m	12,40	12,4	12,4
45 ° / 90 ° dirsek kaybı	m	1,35 - 2,2	1,35 - 2,2	1,35 - 2,2
Duvardaki delik (çap)	mm	130	130	130
<b>Ayrı baca gazı tahliye boruları</b>				
Çap	mm	80	80	80
Maksimum uzunluk	m	10 + 10	16 + 16	16 + 16
45 ° / 90 ° dirsek kaybı	m	1,2 - 1,7	1,2 - 1,7	1,2 - 1,7
<b>Kurulum B23P-B53P</b>				
Çap	mm	80	80	80
Tahliye borusu maksimum uzunluğu	m	14	25	25
NOx sınıfı		3	3	3
<b>Maks Emisyon değerleri. ve min. gaz oranı G20*</b>				
Maksimum - Minimum CO s.a. den az	ppm	100 - 180	120 - 200	120 - 200
CO <sub>2</sub>	%	7,1 - 2,0	7,3 - 2,2	7,3 - 2,2
NOx s.a. den az	ppm	180 - 100	200 - 100	200 - 100
Baca gazı sıcaklığı	°C	127 - 97	142 - 109	142 - 109

\* 0,85 m uzunluğunda, ø 60-100 bir konsantrik boruyla, 80-60°C su sıcaklığında kontrol edilmiştir

## Çoklu gaz tablosu

AÇIKLAMA		Metan gazı (G20)			Butan (G30)			Propan (G31)		
Alt Wobbe indeksi (15 ° C-1013 mbar)	MJ/m <sup>3</sup> S	45,67			80,58			70,69		
Net Kalorifik Değer	MJ/m <sup>3</sup> S	34,02			116,09			88		
Besleme nominal basıncı	mbar (mm W.C.)	20 (203,9)			28 - 30 (285,5 - 305,9)			37 (377,3)		
Besleme minimum basıncı	mbar (mm W.C.)	13,5 (137,7)			-			-		
Brülör (delik sayısı)	n°	11			11			11		
		<b>20 S C.S.I.</b>	<b>24 S C.S.I.</b>	<b>24 S R.S.I.</b>	<b>20 S C.S.I.</b>	<b>24 S C.S.I.</b>	<b>24 S R.S.I.</b>	<b>20 S C.S.I.</b>	<b>24 S C.S.I.</b>	<b>24 S R.S.I.</b>
Brülör (delik çapı)	mm	1,30	1,35	1,35	0,75	0,78	0,78	0,75	0,78	0,78
Maksimum gaz ısıtma kapasitesi	Sm <sup>3</sup> /h	2,35	2,73	2,73						
	kg/h				1,75	2,03	2,03	1,72	2,00	2,00
DHW maksimum gaz kapasitesi	Sm <sup>3</sup> /h	2,35	2,73	-						
	kg/h				1,75	2,03	-	1,72	2,00	-
Minimum gaz ısıtma kapasitesi	Sm <sup>3</sup> /h	0,74	0,94	0,94						
	kg/h				0,55	0,70	0,70	0,54	0,69	0,69
DHW minimum gaz kapasitesi	Sm <sup>3</sup> /h	0,74	0,94	-						
	kg/h				0,55	0,70	-	0,54	0,69	-
Maksimum çıkış basıncı CH valfi	mbar	10,40	11,80	11,80	28,00	27,80	27,80	36,00	35,80	35,80
	mm W.C.	106,05	120,33	120,33	285,52	283,48	283,48	367,10	365,06	365,06
Maksimum çıkış basıncı DHW valfi	mbar	10,40	11,80	-	28,00	27,80	-	36,00	35,80	-
	mm W.C.	106,05	120,33	-	285,52	283,48	-	367,10	365,06	-
Minimum çıkış basıncı CH valfi	mbar	1,20	1,50	1,50	3,00	3,30	3,30	3,90	4,30	4,30
	mm W.C.	12,24	15,30	15,30	30,59	33,65	33,65	39,77	43,85	43,85
Minimum çıkış basıncı DHW valfi	mbar	1,20	1,50	-	3,00	3,30	-	3,90	4,30	-
	mm W.C.	12,24	15,30	-	30,59	33,65	-	39,77	43,85	-

**1 - UPUTSTVA I GARANCIJE**

 Za vreme proizvodnje kotla u našim fabrikama obraća se pažnja i na najmanje delove da bi se zaštitilo ne samo korisnik već i instalater od eventualnih nezgoda. Savetujemo dakle stručnom licu, posle svake intervencije na proizvodu, da obrati posebnu pažnju na električna spajanja, naročito na goli deo provodnika, koji ne sme ni na koji način da izađe iz kućišta, izbegavajući tako mogući kontakt sa živim delovima samog provodnika.

 Priručnik sa uputstvima zajedno sa onim za korisnike, čini integralni deo proizvoda: potrudite se da je uvek pored aparata, čak i u slučaju da pređe kod drugog vlasnika ili korisnika ili da se prebaci na drugo mesto. U slučaju njegovog oštećenja ili gubitka potražite drugi primerak u Tehničkom servisu u Vašem mestu..

 Montažu, popravku ili bilo koju drugu intervenciju treba da obavi stručno lice u saglasnosti sa nacionalnim i lokalnim propisima.

 Savetujemo instalateru da uputi korisnika u funkcionisanje aparata i osnovne norme bezbednosti.

 Ovaj kotao treba da se koristi za šta je i namenjen. I proizvođač se oslobađa bilo kakve odgovornosti po ugovoru i van ugovora od štete koju su uzrokovali ljudi, životinje ili stvari, greške tokom instalacije, regulacije, popravke i nesavesne upotrebe.

 Nakon skidanja ambalaže proverite da li je uređaj kompletan. U slučaju da nije, obratite se prodavcu kod kojeg je kupljen aparat.

 Ispust sigurnosnog ventila aparata treba da se poveže na odgovarajući sistem sakupljanja i odvođenja. Proizvođač aparata nije odgovoran za štete uzrokovane aktiviranjem sigurnosnog ventila.

 Rasporediti materijal ambalaže u odgovarajuće kontejnere u postavljeno mesto sakupljanja.

 Otpad treba da se rasporedi bez štete po zdravlje čoveka i bez upotrebe tehnika ili metoda koji mogu naneti štetu okolini.

Tokom montaže je neophodno informisati korisnika da:







- u slučaju ispusta vode treba da zatvori dovod vode i da hitno obavesti Tehnički servis
- radni pritisak hidrauličkog sistema mora biti u okviru 1 i 2 bara, i stoga, ne sme prelaziti 3 bara. Ako je neophodno, ponovo podesite pritisak kao što je naznačeno u pasusu pod naslovom "Punjenje sistema"
- u slučaju predviđenog dužeg mirovanja kotla poželjno je pozvati Tehnički servis, koji će učiniti barem sledeće:
  - postaviti glavnu sklopku aparata i glavnu sklopku sistema na "ugašeno"
  - zatvoriti slavine za gas i vodu, kako na instalaciji grejanja tako i na instalaciji sanitarne vode
  - isprazniti kako instalaciju grejanja tako i sanitarnu ako postoji rizik od smrzavanja
- održavanje kotla mora se raditi bar jednom godišnje. Ovaj servis treba zakazati unapred kod servisa za tehničku podršku.

Radi bezbednosti dobro je podsetiti:

 Sa se ne preporučuje upotreba kotla deci i osobama sa invaliditetom bez pomoći.

 Da je opasno uključivati ili isključivati električne aparate, kao što su sklopke, kućni aparati i slično, ako se oseća miris gasa ili dimnih gasova. U slučaju propuštanja gasa, potrebno je proventriti prostoriju otvaranjem širom vrata i prozora; zatvoriti

glavnu slavinu za gas; hitno pozvati stručno osoblje iz Tehničkog servisa

-  Ne smete dodirivati kotao ako ste bos i ako su vam delovi tela mokri ili vlažni
-  Pre čišćenja kotla isključite električno napajanje tako da se dvopolna sklopka instalacije i glavna sklopka na kontrolnoj tabli postave na položaj "OFF"
-  Zabranjeno je menjati zaštitne uređaje ili postavljene vrednosti bez ovlašćenja ili uputstva proizvođača
-  Nemojte povlačiti, odvajati, uvijati električne kablove koji izlaze iz kotla čak i onda kad je isključeno električno napajanje
-  Izbegavajte začepljivanje ili smanjivanje vazдушnih otvora u prostoriji u kojoj se nalazi aparat
-  Nemojte ostavljati kutije i zapaljive materije u prostoriji u kojoj je instaliran aparat
-  Nemojte ostavljati ambalažu deci na dohvata ruke.

**2 - OPIS KOTLA**

**Ciao S C.S.I.** je zidni kotao tipa C koji se koristi za grejanje i proizvodnju tople sanitarne vode: prema odvodu za dimne gasove koji se koristi može se razvrstati na sledeće kategorije B22P, B52P, C12, C22, C32, C42, C52, C62, C82, C92, C12x, C32x, C42x, C52x, C62x, C82x, C92x.

**Ciao S R.S.I.** je model zidnog kotla tipa C, a koji može da funkcioniše pod različitim okolnostima:

**SLUČAJ A**

samo zagrevanje bez ikakvog povezanog spoljašnjeg bojlera. Kotao ne snabdeva sanitarnom toplom vodom.

**SLUČAJ B**

samo zagrevanje sa povezanim spoljašnjim bojlerom, kojim upravlja termostad: u tom slučaju na svaki toplotni zahtev upućen od strane termostata bojlera, kotao obezbeđuje toplu vodu za pripremu sanitarne vode.

**SLUČAJ C**

samo zagrevanje sa povezanim spoljašnjim bojlerom (dodatni pribor na zahtev), kojim upravlja temperaturna sonda, za pripremu sanitarne tople vode. Ukoliko se povezuje bojler drugog dobavljača, postarati se da NTC sonda koja se koristi ima sledeće karakteristike: 10 kOhm na 25°C, B 3435 ±1%

U konfiguraciji B22P, B52P (kada je instalirana unutra) ovaj uređaj ne može biti instaliran u prostorijama namenjenim za spavaću sobu, kupatilo, tuš ili gde su prisutni kamini bez sopstvenog dovoda vazduha. Prostorija u kojoj se instalira kotao mora da ima odgovarajuće provetranje.

Tip aparata C može se instalirati u bilo kojoj prostoriji i nema ograničenja vezanih za provetranje i zapreminu prostorije.

**3 - INSTALACIONI PROPISI****3.1 Instalacioni propisi**

Instalaciju mora obaviti stručno lice.

Mora se takođe pridržavati nacionalnih i lokalnih pravila.



**MESTO**

**Ciao S** može biti instaliran u unutrašnjem prostoru (sl. 2).

Kotao ima garanciju da pravilno funkcioniše u rasponu temperature od 0°C do 60°C.

Da bi se mogao koristiti aparat mora biti u stanju da se uključi, da ga ništa ne blokira (npr. nedostatak gasa ili električnog napajanja, ili intervencija po pitanju bezbednosti), deaktivira upotrebu.

U određenim delovima priručnika se koriste simboli:

-  PAŽNJA = za radnje koje zahtevaju posebnu opreznost i odgovarajuću pripremu
-  ZABRANJENO = za radnje koje NE SMEJU apsolutno da se izvedu

**MINIMALNI RAZMACI**

Da bi se omogućio pristup unutrašnjosti kotla i izvođenje uobičajenih radnji održavanja, neophodno je poštovati minimalne razmake prilikom montaže kotla (sl. 3).

Da biste pravilno montirali aparat vodite računa da:

- ne sme se montirati iznad bilo koje vrste šporeta
- zabranjeno je ostaviti zapaljive materije u prostoriji u kojoj je instaliran kotao
- zidovi osetljivi na toplotu, npr. drveni, moraju biti zaštićeni odgovarajućom izolacijom.

**VAŽNO**

Pre montaže se savetuje temeljno ispiranje cevi da bi se uklonili eventualni ostaci koji bi onemogućili dobro funkcionisanje aparata. Montirati ispod sigurnosnog ventila jedan levak za vodu koji bi je i odvodio u slučaju prevelikog pritiska zagrevanja uređaja. Za strujno kolo sanitarne vode nije neophodan sigurnosni ventil, ali je neophodno obezbediti da pritisak vodovoda ne premašuje 6 bar. U slučaju da niste sigurni, savetuje se da montirate umanjivač pritiska.

Pre uključivanja, proverite da li je kotao predviđen za upotrebu sa dostupnim gasom; ovo možete saznati sa natpisa na ambalaži i nalepljenoj etiketi za vrstu gasa.

Veoma je važno utvrditi da su u određenim slučajevima dimne cevi pod pritiskom i stoga različiti elementi moraju biti spojeni hermetički.

**ANTIFRIZ SISTEM**

Kotao je opremljen serijom automatskog antifriz sistema, koji se aktivira kada se temperatura vode primarnog strujnog kola spusti ispod 6 °C. Ovaj sistem je uvek aktivan i garantuje zaštitu kotla do spoljne temperature od -3 °C. Da biste iskoristili ovu zaštitu (na osnovu rada gorionika), kotao

mora biti u stanju da se sam uključi; odatle proizilazi da svaka mogućnost blokade (npr. nestanak gasa ili električnog napajanja, ili pak intervencija nekog bezbednosnog sistema) deaktivira zaštitu.

Antifriz zaštita je aktivna i kada je kotao na stand-baju.

U normalnim uslovima rada, kotao je u mogućnosti da se samozaštiti od smrzavanja. Ukoliko je mašina ostavljena bez napajanja u dužem vremenskom periodu u predelima gde se mogu ostvariti temperature niže od 0°C i ne može se izvršiti praznjenje instalacije grejanja, za antifriz zaštitu te mašine savetuje se da se u primarno strujno kolo uvede antifriz dobrog brenda. Pažljivo sledite uputstva proizvođača ne samo u pogledu procenata antifriz tečnosti koju ćete koristiti za minimalnu temperaturu pri kojoj želite da držite kolo mašine, već takođe u pogledu trajanja i odlaganja same tečnosti.

Što se tiče sanitarnog dela, predlaže se praznjenje strujnog kola. Materijali od kojih su napravljene komponente kotlova otporni su na tečnosti koje zamrzavaju i koje su na bazi etilenskih glikola.

**3.2 Fiksiranje kotla na zid i hidraulična povezivanja**

Da biste fiksirali kotao na zid koristite alat (sl. 4-5) koji je u ambalaži. Položaj i veličina hidrauličnih spojeva su prikazani detaljno:

<b>A</b>	povratni vod	3/4"
<b>B</b>	potisni vod	3/4"
<b>C</b>	priključak za gas	3/4"
<b>D</b>	Sanitarni izlaz	1/2" (za C.S.I.) - 3/4" (za R.S.I.)
<b>E</b>	Sanitarni ulaz	1/2" (za C.S.I.) - 3/4" (za R.S.I.)

U slučaju zamene kotla Beretta raspona gore pomenutog, dostupan je komplet za prilagođavanje hidrauličnih spojeva.

**3.3 Električno povezivanje**

Kotlovi izlaze iz fabrike kompletno opremljeni kablovima sa kablom za električno napajanje već električno povezanim i neophodna im je samo povezanost na sobni termostat (TA) u određena kućišta.

Da bi se pripojilo kućištu:

- isključite glavni prekidač sistema
- odvrnite zavrtnje (A) koji čine zaštitni sloj (sl. 6)
- pomerite prema napred a onda gore osnovu zaštitnog sloja da bi ga skinuli sa postolja
- odvrnite zavrtnje koji fiksiraju (B) omotač (sl. 7)
- okrenite kontrolnu tablu prema sebi
- skinite najlon sa kućišta (sl. 8)
- ubacite kabl u krajnji T.A. (sl. 9)

Sobni termostat treba da se spoji kao što je prikazano na shemi.

**⚠ Ulazni sobni termostat niske voltaže (24 VDC).**

Povezivanje na električnu mrežu treba da se ostvari pomoću pribora

za odvajanje sa svepolarnim otvorom od bar 3,5 mm (EN 60335-1, kategorija III).

Uređaj radi sa naizmeničnom strujom od 230 Volt/50 Hz i električnim napajanjem od 100W za 20 C.S.I. - 115W za 24 C.S.I. - 24 R.S.I. (i u skladu je sa standardom EN 60335-1).

⚠ Obavezno je spajanje sa efikasnim alatom za uzemljenje, u saglasnosti sa nacionalnim i lokalnim propisima.

⚠ Savetujemo da poštujuete spajanje neutralne faze (L-N).

⚠ Provodnik za uzemljenje treba da bude par centimetara duži od drugih.

⚠ **Zabranjena je upotreba cevi za gas i/ili vodu kao uzemljenja električnih aparata.**

Proizvođač ne snosi odgovornost za eventualnu štetu uzrokovanu odsustvom uzemljenja aparata.

Za električno napajanje koristite **kabl za napajanje koji se nalazi u priboru.**

U slučaju zamene kabla za napajanje, koristite kabl tip **HAR H05V2V2-F, 3 x 0,75 mm<sup>2</sup>, maksimalnog spoljašnjeg prečnika 7 mm.**

**3.4 Priključivanje gasa**

Pre priklučivanja aparata na gasnu mrežu, proverite da:

- su poštovani važeći nacionalni i lokalni propisi za instalaciju
- vrsta gasa je onaj za kojeg je aparat predviđen
- su cevi čiste.

Predviđen je spoljni odvod gasa. U slučaju da cev vodi kroz zid, ona mora proći kroz središnju rupu na donjem delu zida.

Ako u gasu ima čvrstih čestica savetuje se ugradnja filtera na gasnoj instalaciji odgovarajućih dimenzija.

Po završetku instalacije treba proveriti zaptivanje svih spojeva kako to nalažu važeći propisi za montažu

**3.5 Odvođenje produkata sagorevanja i usisavanje vazduha**

Za odvođenje produkata sagorevanja važe već napravljeni propisi. Takođe se treba pridržavati lokalnih normi Vatrogasne službe, Agencije za gas i eventualnih opštinskih propisa.

Odvođenje produkata sagorevanja obezbeđuje centrifugalni ventilator smešten unutar komore za sagorevanje i njeno pravilno funkcionisanje stalno kontroliše sistem nadzora. Kotao se isporučuje bez kompleta za odvođenje dimnih gasova/usisavanja vazduha, jer se može koristiti pribor za uređaje sa zatvorenom komorom i prisilnom ventilacijom, koji najbolje odgovara potrebama montaže.

Za odvođenje dimnih gasova i dovod svežeg vazduha moraju se koristiti samo naše originalne cevi a montaža mora biti pravilno izvedena u skladu sa uputstvima priloženim uz pribor.

U jedan dimnjak se može spojiti više uređaja pod uslovom da su svi uređaji sa zatvorenom komorom.

**INSTALACIJA "PRINUDNO OTVOREN" (TIP B22P/B52P)****Cev za isparenja Ø 80 mm (sl. 10a)**

Ispusna cev za odvod isparenja može se usmeriti u željenom smeru za potrebe instalacije. Za instalaciju pratite instrukcije dostavljene sa opremom.

⚠ U ovoj konfiguraciji, kotao je povezan sa ispusnom cevi za odvod isparenja Ø 80 mm uz pomoć adaptera Ø 60-80 mm. U ovom slučaju, vazduh za podršku sagorevanju odvodi se iz prostorije u kojoj je kotao instaliran, a to mora biti odgovarajuća tehnička prostorija sa ventilacijom.

⚠ Ispusne cevi koje nisu izolovane predstavljaju potencijalnu opasnost.

Prsten za dimne gasove (F), kada je neophodno treba da se skinu koristeći odvijač kao polugu.

Kotao automatski prilagođava ventilaciju prema tipu instalacije i dužini cevi.

**20 C.S.I.**

Dužina cevi Ø 80 [m]	Prsten za dimne gasove (F)	Pad pritiska na svakom kolenu (m)	
		45°	90°
do 1,5	Ø 39	1,2	1,7
od 1,5 do 5	Ø 41 (**)		
od 5 do 14	Ø 43		

(\*\*) montirana u kotlu

## 24 C.S.I. - 24 R.S.I.

Dužina cevi Ø 80 [m]	Prsten za dimne gasove (F)	Pad pritiska na svakom kolenu (m)	
		45°	90°
do 2	Ø 42	1,2	1,7
od 2 do 8	Ø 44 (**)		
od 8 do 25	nije instalirana		

(\*\*) montirana u kotlu

## SKOAKSIJALNI ODVOD (Ø 60-100)

Kotao se isporučuje pripremljen za spajanje na koaksijalni cevovod za odvod/dovod i sa otvorom za usis vazduha (E) zatvorenim (sl. 10b). Koaksijalni odvod može biti usmeren u najpovoljnijem smeru, poštujući maksimalne dužine navedene u tabeli. Tokom instalacije sledite uputstva koja dobijate uz opremu.

U zavisnosti od dužine upotrebljenih cevi, neophodno je ubaciti prsten birajući među onima koje se nalaze u kotlu (pogledajte tabele koje slede). Prsten za dimne gasove (F), kada je neophodno treba da se skine koristeći odvijač kao polugu. Na tabeli su predstavljene dužine postavljenih dimovoda. U zavisnosti od dužine upotrebljenih cevi, neophodno je ubaciti prsten birajući među onima koje se nalaze u kotlu (pogledajte tabele koje slede).

## 20 C.S.I.

Dužina cevi Ø 60-100 [m]	Prsten za dimne gasove (F)	Pad pritiska na svakom kolenu (m)	
		45°	90°
do 0,85	Ø 39	1	1,5
od 0,85 do 2,35	Ø 41 (**)		
od 2,35 do 4,25	Ø 43		

(\*\*) montirana u kotlu

## 24 C.S.I. - 24 R.S.I.

Dužina cevi Ø 60-100 [m]	Prsten za dimne gasove (F)	Pad pritiska na svakom kolenu (m)	
		45°	90°
do 0,85	Ø 42	1	1,5
od 0,85 do 2,35	Ø 44 (**)		
od 2,35 do 4,25	nije instalirana		

(\*\*) montirana u kotlu

## Koaksijalne cevi (Ø 80/125)

Kotao se isporučuje pripremljen za spajanje na koaksijalni cevovod za odvod/dovod i sa otvorom za usis vazduha zatvorenim. Koaksijalni odvod može biti usmeren u najpovoljnijem smeru, poštujući maksimalne dužine navedene u tabeli.

Tokom instalacije sledite uputstva koja dobijate uz opremu. Izbušiti rupu na zidu Ø 140 mm. Zavisno od dužine upotrebljenih cevi, neophodno je ubaciti jedan prsten birajući među onima u kotlu (**vidite tabelu**). Obratite posebnu pažnju na spoljnu temperaturu i na dužinu cevi. Pogledati grafikone da bi utvrdili da li je obavezna ili ne upotreba sakupljača kondenzacije. U slučaju funkcionisanja kotla na temperaturi nižoj od 60 °C, obavezna je upotreba sakupljača kondenzacije. U slučaju upotrebe sakupljača kondenzacije uzmete u obzir ulegnuće cevi za odvod dimnih gasova do 1% prema samom sakupljaču.

Povezati sifon sakupljača kondenzacije na ispus vode.

Ispusne cevi koje nisu izolovane predstavljaju potencijalnu opasnost.

## 20 C.S.I.

Dužina cevi Ø 80 125 [m]	Prsten za dimne gasove (F)	Pad pritiska na svakom kolenu (m)	
		45°	90°
od 0,96 do 3,85	Ø 39	1,35	2,2
od 3,85 do 7,85	Ø 41 (**)		
od 7,85 do 12,40	Ø 43		

(\*\*) montirana u kotlu

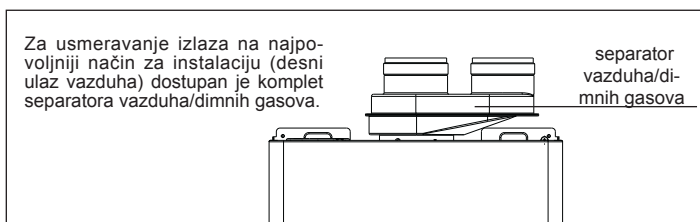
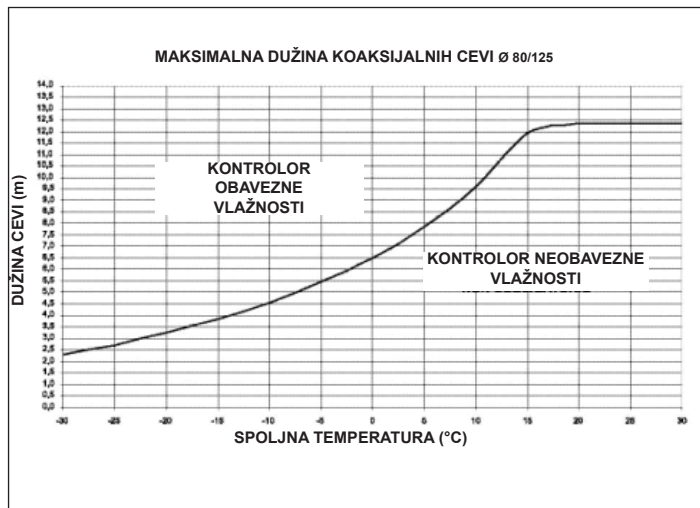
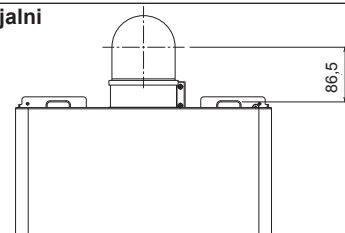
komplet za koaksijalni  
sniženi nagib

⚠ Ako je neophodno instalirati Ciao S na već postojeće uređaje (zamena opsega Ciao N/Mynute), dostupan je komplet za "koaksijalni sniženi nagib" koji omogućava nameštanje kotla i iste rupe za izlaz dimnih gasova.

Dužina cevi sa spuštenim nagibom [m]	Prsten za dimne gasove (F)		Pad pritiska na svakom kolenu (m)	
	Ciao S 20 C.S.I.	Ciao S 24 C.S.I.	45°	90°
do 1,85	Ø 41	Ø 44	1	1,5
od 1,85 do 4,25	Ø 43	bez prstena		

## 24 C.S.I. - 24 R.S.I.

Dužina cevi Ø 80 125 [m]	Prsten za dimne gasove (F)	Pad pritiska na svakom kolenu (m)	
		45°	90°
od 0,96 do 3,85	Ø 42	1,35	2,2
od 3,85 do 7,85	Ø 44 (**)		
od 7,85 do 12,4	nije instalirana		

(\*\*) montirana u kotlu

**ODVOJENI SISTEM (ø 80) (sl. 11)**

Odvojeni sistem možete usmeriti u pravcu koji najviše odgovara prostoriji.

Da biste koristili cev za usisavanje vazduha za sagorevanje, jedan od dva ulaza (G i H) mora biti izabran. Uklonite čep za zatvaranje koristeći zavrtnje, i iskoristite specijalni adapter koji se odnosi na odabrani ulaz.

⚠ Adapter ulaza vazduha ø 80 (X) mora biti pravilno orijentisan, zbog toga je neophodno da se on namesti uz korišćenje adekvatnih zavrtnja, tako da ploča za postavljanje ne smeta kućištu: X adapter ulaza vazduha ø 80 - Y adapter ulaza vazduha od ø 60 do ø 80.

Prsten za dimne gasove (F), kada je neophodno treba da se skinu koristeći odvijač kao polugu. Na tabeli su predstavljene dužine postavljenih dimnovoda. U zavisnosti od dužine upotrebljenih cevi, neophodno je ubaciti prsten birajući među onima koje se nalaze u kotlu (pogledajte tabele koje slede).

**20 C.S.I.**

Dužina cevi ø 80 [m]	Prsten za dimne gasove (F)	Pad pritiska na svakom kolenu (m)	
		45°	90°
1+1	Ø 39	1,2	1,7
> 1+1 ÷ 4+4	Ø 41 (**)		
> 4+4 ÷ 10+10	Ø 43		

(\*\*) montirana u kotlu

**24 C.S.I. - 24 R.S.I.**

Dužina cevi ø 80 [m]	Prsten za dimne gasove (F)	Pad pritiska na svakom kolenu (m)	
		45°	90°
2+2	Ø 42	1,2	1,7
>2+2 ÷ 6+6	Ø 44 (**)		
>6+6 ÷ 16+16	nije instalirana		

(\*\*) montirana u kotlu

**3.6 Punjenje instalacije za grejanje (sl. 13)**

Nakon što se spoji voda, može se pristupiti punjenju instalacije za grejanje. Ovo se obavlja dok je instalacija hladna po sledećem postupku:

- okrenite čep automatskog ventila za ispušt vazduha (I) dva ili tri kruga
- proverite je li slavina za ulaz hladne vode otvorena
- okrećite slavinu za punjenje (L sl. 13 za C.S.I. - eksterna za R.S.I.) dok pritisak pokazan na meraču pritiska vode ne bude između 1 i 1,5 bara.

Po završetku punjenja zatvorite slavinu za punjenje.

Kotao je opremljen efikasnim separatorom vazduha, pa nije potreban nikakav ručni zahvat. Gorionik se pali tek onda kad je faza ispuštanja vazduha završena.

**3.7 Pražnjenje instalacije grejanja**

Kod pražnjenja instalacije postupite na sledeći način:

- ugasite kotao
- otvorite slavinu za pražnjenje kotla (M)
- ispuštite vodu na najnižim tačkama instalacije.

**3.8 Ispuštanje sanitarne vode (samo za model C.S.I.)**

Uvek kad postoji opasnost od smrzavanja, mora se ispuštiti voda iz sanitarne instalacije na sledeći način:

- zatvorite glavni ventil vodovodne mreže
- otvorite sve slavine tople i hladne vode
- ispuštite vodu na najnižim tačkama instalacije.

**NAPOMENA**

Ispust sigurnosnog ventila (N) aparata treba da se poveže na odgovarajući sistem sakupljanja i odvođenja. Proizvođač aparata nije odgovoran za štete uzrokovane aktiviranjem sigurnosnog ventila.

**B22P/B52P** Usisavanje u prostoriji i odvod napolje

**C12-C12x** Koncentrični odvod kroz zid. Cevi mogu krenuti odvojeno od kotla, ali izlazi moraju biti koncentrični ili vrlo blizu da bi bili izloženi sličnim uticajima vetra (do 50 cm)

**C22** Koncentrični odvod u zajednički dimnjak (usis i odvod u isti dimnjak)

**C32-C32x** Koncentrični odvod na krov. Izlaz kao C13

**C42-C42x** Odvod i usis u odvojene zajedničke dimnjake, ali izložene sličnim uticajima vetra

**C52-C52x** Odvod i usis odvojeni na zid ili krov, ali u područja sa različitim pritiscima. Odvod i usis ne smeju nikada biti na suprotnim stranama

**C62-C62x** Odvod i usis izrađeni od odvojeno prodvanih sertifikovanih cevi (1856/1)

**C82-C82x** Odvod u pojedinačni ili zajednički dimnjak a usis je sa fasade

**C92-C92x** Odvod na krovu (slično C33) i usisavanje vazduha u jedini postojeći dimnjak

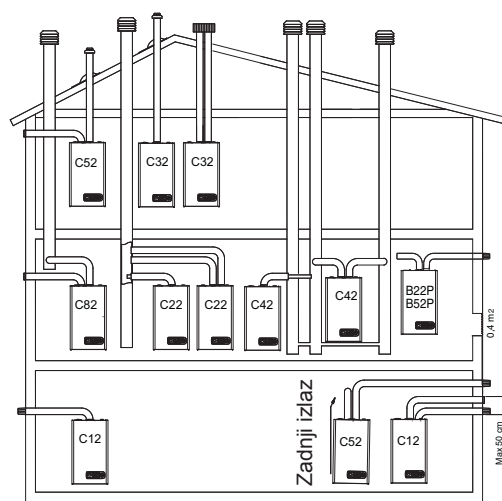

## 4 UKLJUČIVANJE I RAD UREĐAJA

### 4.1 Preliminarne provere

**Prvo uključivanje obavlja stručno lice iz Tehničkog centra kojeg je ovlastila Beretta.**

Pre paljenja kotla proverite:

- da su podaci mreža napajanja (električne, vodovodne, gas) odgovarajući onima na pločici
- da su cevi koje izlaze iz kotla pokrivene termoizolacionim omočaćem
- da su cevi za izvlačenje dima i usisavanje vazduha ispravne
- da su obezbeđeni uslovi za normalnu upotrebu u slučaju da kotao bude unutar ili između nameštaja
- da je pripremljen dotok gasa
- da raspon grejanja odgovara traženim vrednostima kotla
- da je uređaj za dotok gasa u skladu sa potrebnim opsegom kotla i da je opremljen svim sigurnosnim i kontrolnim sredstvima koje propisuju postojeće norme.

### 4.2 Uključivanje aparata



Da biste uključili kotao, neophodno je da uradite sledeće operacije:

- priključite kotao na struju
- otvorite slavinu za dovod gasa koja se nalazi na uređaju, da biste omogućili paljenje
- okrenite birač funkcija (1 - sl. 1a) u željeni položaj:

#### Ciao S C.S.I.:

**Leto:** okrenite birač na simbol leto  (sl. 2a) aktivira se funkcija samo za toplu sanitarnu vodu. Ako postoji zahtev za toplom vodom digitalni displej prikazuje temperaturu sistema tople vode, ikonu da bi naznačio dovod tople vode i ikonu plamena

**Zima:** okretanjem birača funkcije u okviru zone obeležene + i - (sl. 2b), kotao obezbeđuje sanitarnu vodu i grejanje. Ako postoji zahtev za grejanjem, kotao se uključuje i digitalni monitor prikazuje temperaturu vode za grejanje, ikonu grejanja i ikonu plamena (sl. 3a). Ako postoji zahtev za sanitarnom vodom, kotao se uključuje i digitalni displej prikazuje temperaturu sistema tople vode, ikonu za dovod tople vode i ikonu plamen (sl. 4a)

**Predzagrevanje** (brže do vruće vode): rotirajte dugme za podešavanje temperature vruće vode (2 - sl. 1a) do  simbola (sl. 5a), da biste aktivirali funkciju predzagrevanja. Ova opciju omogućava da se održi topla voda što omogućuje izmenjivač sanitarne vode i smanjuje vreme čekanja. Kada se aktivira funkcija predzagrevanja, monitor prikazuje temperaturu dovoda vode za grejanje ili sanitarne vode, u skladu sa trenutnim zahtevom. Tokom paljenja koje prati predzagrevanje, ekran pokazuje **P** simbol (sl. 5b). Kako biste deaktivirali opciju predzagrevanja, potrebno je da vratite dugme za podešavanje temperature vruće vode na  simbol. Vratiti dugme za ručno podešavanje temperature sanitarne vode na željenu poziciju. Funkcija nije aktivna kada je kotao na OFF: birač funkcije (1 sl.1a) na  OFF.

#### Ciao S R.S.I.:

**Letnji režim (samo sa povezanim spoljnim rezervoarom za vodu):** okrećući birač na simbol leto  (sl. 2a) aktivira se tradicionalna funkcija sanitarne tople vode i kotao će se aktivirati na temperaturi postavljenoj na spoljnom aparatu za prokuvavanje. If Ako postoji zahtev za toplom vodom digitalni displej prikazuje temperaturu sistema tople vode, ikonu da bi naznačio dovod tople vode i ikonu plamena

**Zima:** okretanjem birača funkcije u okviru zone označene + i - (sl. 2b), kotao obezbeđuje toplu vodu za grejanje i - ako je povezan sa spoljnim aparatom za prokuvavanje - sanitarnu toplu vodu. Ako postoji zahtev za grejanjem, kotao se uključuje i digitalni monitor prikazuje temperaturu vode za grejanje, ikonu grejanja i ikonu plamena (sl. 3a). Ako postoji zahtev za sanitarnom vodom, kotao se uključuje i digitalni displej prikazuje temperaturu sistema tople vode, ikonu za dovod tople vode i ikonu plamen (sl. 4a).

Postavite sobni termostat na željenu temperaturu (~20°C)

#### Ciao S C.S.I.: Podešavanje temperature sanitarne vode

Da biste regulisali temperaturu sanitarne tople vode (kupatila, tuševi, kuhinja, itd.), okrenite dugme sa simbolom  (sl. 2b) u okviru zone označene + i -.

Kotao je u stanju pripreme dok se gorionik ne uključi zbog zahteva za toplom vodom i digitalni displej pokazuje temperaturu sistema tople vode, ikonu dovoda tople vode i ikonu plamena

Kotao će biti u funkciji dok se ne postignu željene temperature, posle čega će ponovo biti u stanju "stand-by".

Ukoliko se uključi led crvene boje blizu simbola  na kontrolnoj tabli, to znači da je kotao u stanju privremenog zastoja rada (potrebno je videti odeljak sa svetlećom signalizacijom i kvarovima). Na digitalnom displeju se prikazuje kod određenog kvara (sl. 6a).

#### Ciao S R.S.I.: Podešavanje temperature sanitarne vode

**CASE A** samo grejanje - podešavanje se ne primenjuje

**SLUČAJ B** samo zagrevanje + spoljašnji bojler sa termostatom – regulacija nije primenljiva.

**SLUČAJ C** samo grejanje + spoljni rezervoar sa sondom – da biste podesili temperaturu sanitarne tople vode u rezervoaru, okrenite prekidač – ali, sa simbolom u smeru kazaljke na satu za povećavanje temperature vode i u smeru suprotnom od kazaljke na satu za smanjivanje.

Kotao je u stanju pripreme dok se gorionik ne uključi zbog zahteva za toplom vodom i digitalni displej prikazuje temperaturu sistema tople vode, ikonu dovoda tople vode i ikonu plamena

Kotao će biti u funkciji dok se ne postignu željene temperature, posle čega će ponovo biti u stanju "stand-by".

Ukoliko se uključi led crvene boje blizu simbola  na kontrolnoj tabli, to znači da je kotao u stanju privremenog zastoja rada (potrebno je videti odeljak sa svetlećom signalizacijom i kvarovima). Na digitalnom displeju se prikazuje kod određenog kvara (sl. 6a)

#### Ciao S C.S.I. - Ciao S R.S.I.: Funkcija za automatski sistem za regulaciju (S.A.R.A.) sl. 7a

Postavljanjem birača temperature za grejanje vode u delu na kojem piše AUTO - vrednost temperature od 55 do 65°C - aktivira se sistem samoregulisanja S.A.R.A.: Kotao menja izlaznu temperaturu vode zavisno od signala zatvaranja sobnog termostata. Kad se postigne nameštena temperatura pomoću birača za grejanje vode, počinje odbrojavanje od 20 minuta. Ako u toku ovog perioda sobni termostat i dalje bude tražio dovod toplote, nameštena vrednost temperature će se automatski podignuti za 5 °C.

Kada je dostignuta nova vrednost, počinje još jedno odbrojavanje od 20 minuta.

Ako tokom ovog perioda, spoljni termostat i dalje zahteva zagrevanje, vrednost podešene temperature se automatski povećava za 5 °C. Ova nova početna vrednost temperature je rezultat ručnog podešavanja temperature grejanja vode i porasta temperature vode od +10 °C funkcije S.A.R.A.

Nakon drugog ciklusa vrednost temperature bi trebalo držati na postavljenoj vrednosti +10°C dok se ne zadovolji zahtev sobnog termostata.

### 4.3 Isključivanje

#### Privremeno isključivanje

U slučaju kraćeg odsustva postavite birač funkcije (1 - sl. 1a) u položaj  (OFF).

Na ovaj način ostavljajući aktivno električno napajanje i dovod goriva, kotao je zaštićen sistemima:

- **Uređaj protiv zamrzavanja:** kada je temperatura vode u kotlu ispod 5°C aktivira se cirkulaciona pumpa a, ukoliko je potrebno, i gorionik sa minimalnom snagom kako bi se temperatura vode vratila na sigurne vrednosti (35°C). Tokom ciklusa protiv zamrzavanja na digitalnom displeju se pojavljuje simbol  na digitalnom monitoru.

- **Funkcija protiv blokade cirkulacione pumpe:** ciklus rada se aktivira na svaka 24 sata.

- **Sanitarni antifriz (samo kada je povezan na spoljni rezervoar sa sondom):** funkcija se aktivira ukoliko izlazna temperatura sonde bojlera padne ispod 5°C. U toj fazi nastaje toplotni zahtev sa paljenjem gorionika sa minimalnom snagom, koja se održava sve dok izlazna temperatura vode ne dostigne 55°C. Tokom ciklusa protiv zamrzavanja na digitalnom monitoru se pojavljuje simbol .





















### Isključivanja na duže vreme

U slučaju dužeg odsustva postavite birač funkcije (1 - sl. 1a) u položaj  (OFF).



Zatvorite zatim slavinu za dovod gasa smeštenu iznad kotla. U ovom slučaju funkcija zaštite od smrzavanja je deaktivirana: ispraznite vodu iz instalacije ako postoji rizik od smrzavanja.

### 4.4 Svetlosna signalizacija i nepravilnosti





Radni status kotla je prikazan na digitalnom displeju, ispod se nalazi lista vrsti displeja.

STATUS KOTLA	DISPLEJ
Mirovanje	-
OFF status	OFF
Alarm zaključavanja ACF modula	A01  
Alarm električnog kvara ACF	A01  
Alarm graničnog termostata	A02 
Alarm vazdušnog presostata	A03 
Alarm vodenog presostata	A04  
Kvar NTC sanitarne vode (C.S.I. i R.S.I samo sa eksternim grejačem rezervoara i sondom)	A06 
Kvar NTC grejanja	A07 
Parazitski plamen	A11 
Električna kalibracija minimalnog i maksimalnog grejanja	ADJ 
Kratkotrajno očekivanje paljenja	88°C trepće
Intervencija vazdušnog presostata	 treptanje
Intervencija vodenog presostata	  treptanje
Aktivna funkcija predzagrevanja (samo C.S.I.)	P
Zahtev za zagrevanjem predzagrevanja (samo C.S.I.)	P trepće
Eksterna sonda prisutna	
Zahtev za grejanjem sanitarne vode	60°C 
Zahtev za grejanjem	80°C 
Zahtev za grejanjem antifrizna	
Plamen prisutan	

### Da biste ponovo uspostavili funkcionisanje (deblokada alarma): Kvarovi A 01-02-03

Postavite birač funkcije na isključeno  (OFF), sačekajte 5-6 sekundi i ponovo vratite na željenu poziciju  (leto) ili  (zima). Ukoliko postupci koje ste primenili nisu reaktivirali kotao potrebno je pozvati tehničku podršku.

### Kvarovi A 04

Na digitalnom displeju pored koda za kvar, je simbol . Utvrditi vrednost pritiska prikazanu na hidrometru: ako je niža od 0,3 bara, postavite birač funkcije na  (OFF) i podesite slavinu za punjenje (L sl. 13 za C.S.I. - eksterna za R.S.I.) dok pritisak ne postigne vrednost između 1 i 1,5 bara. Postavite birač funkcije na željenu poziciju  (leto) ili  (zima). Kotao će obaviti jedan ciklus ozračivanja u trajanju od oko 2 minuta. Ukoliko je pad pritiska vode česta pojava obratite se našoj tehničkoj podršci.

### Kvar A 06 (samo C.S.I.)

Kotao normalno radi, ali ne garantuje stabilnost temperature sanitarne vode koja ostaje podešena približno na temperaturu oko 50°C. POTREBNA je intervencija servisa.

### Kvarovi A 07

Obratiti se Servisu za tehničku podršku.

### 4.5 Podešavanja

Kotao je već u fazi izrade usklađen određenim pravilima i funkcijama. Međutim, ako bi bilo neophodno napraviti dodatna usklađivanja kao

što se dešava kada je u pitanju zamena ventila gasa nakon promene gasa, tada treba slediti sledeća uputstva.

### **Podešavanja maksimalne snage mora biti izvršeno od strane stručnog lica.**

- skinuti poklopac i zavrtnuti zavrtnje dok se ne fiksira A (sl. 6)
- Vrtite zavrtnje dva puta i odvijte zavrtnj za pritisak prema dole postavljenom ventilu za gas i objediniti ih manometrom
- odvojite poklopac kako bi se ispustio nakupljeni vazduh

### 4.5.1 Ciao S C.S.I.: Maksimalna snaga i minimalno podešavanje sanitarne tople vode

- Otvorite ventil sa toplom vodom do maksimalne protočnosti
- Na kontrolnoj tabli:
- Postaviti birač funkcije na  (leto) (sl. 2a)
- birač temperature podesiti na maksimalnu vrednost sanitarne vode (sl. 8a)
- Napuniti kotao postavljajući glavnu tablu sa komandama na zid Gore pri "ulazu"
- Proverite da li je pritisak koji pokazuje manometar stabilan; ili pak pomoću miliamperometra u seriji modulatora koji bi osigurao činjenicu da modulator donosi najveću moguću protočnost (120 mA za G20 i 165 mA za GPL).
- Potrebno je ukloniti zaštitnu kapu sa zavrtnja za podešavanje, pažljivo ključem za odvijanje (sl. 15)
- Sa viljuškastim ključem CH10 okretati i pritiskom podesiti do maksimalne snage, kako bi se održala vrednost koja je prikazana u tabeli "Tehnički podaci"
- Prekinite vezu sa modulatorom
- Sačekajte i vidite da li će se pritisak prikazan na manometru stabilizovati do minimalne vrednosti
- Allen ključem delovati na crvene zavrtnje za regulaciju minimalne sanitarne vrednosti, ali pri tom paziti da se greškom ne oštete unutrašnje osovine, i podesiti sve dok se na manometru mogu pročitati vrednosti koje su prikazane u tabeli "Tehnički podaci"
- Ponovno povezivanje sa modulatorom
- Zatvorite ventil sa toplom vodom
- Pažljivo ponovo namestite zaštitne kape na zavrtnje za regulaciju.

### Ciao S R.S.I.: Podešavanja maksimalne i minimalne snage

- Postavite birač funkcije na  (zima) (sl. 2b)
- Skinite poklopac i dođite do kartice
- umetnite jumpere JP1 i JP2
- Dovedite do maksimalne vrednosti trimer P2 koristeći odvijač (okretati u smeru kazaljke na satu)
- Napuniti kotao postavljajući glavnu tablu sa komandama na zid gore pri "ulazu"
- Proverite da li je pritisak koji pokazuje manometar stabilan; ili uz pomoć miliamperometra koji je u seriji modulatora, osiguravajući da modulator dostigne maksimalnu moguću trenutnu raspoloživu vrednost (120 mA za G20 i 165 mA za GPL)
- Uklonite zaštitni poklopac sa vijaka radi regulacije mehanizma, ali pažljivo koristeći odvijač
- Sa viljuškastim ključem CH10 okretati i pritiskom podesiti do maksimalne snage, kako bi se održala vrednost koja je prikazana u tabeli "Tehnički podaci"
- Prekinite vezu sa modulatorom
- Sačekajte i vidite da li će se pritisak prikazan na manometru stabilizovati do minimalne vrednosti
- Allen ključem otklonite crvene vijke za regulaciju minimalne snage i podesite sve dok se na manometru ne pojavi vrednost koja je prikazana u tabeli "Tehnički podaci"
- Ponovno povezivanje sa modulatorom
- Isključite kotao sa napajanja
- Ukloniti džampere JP1 i JP2
- Pažljivo ponovo namestite zaštitne kape na zavrtnje za regulaciju.

### 4.5.2 Električna regulacija minimalnog i maksimalnog grejanja

 Funkcija "električne regulacije" aktivira se i deaktivira isključivo sa džamperom (JP1) (sl. 16).

ADJ  se pojavljuje na displeju da naznači da je procedura kalibracije u toku.

Osposobljavanje funkcija možete se izvršiti na sledeće načine:

- pomoću kartice koja u sebi sadrži jumper JP1, sa selektorom koji sadrži funkciju u zimskom periodu, bez obzira na prisustvo drugih aplikacija.
- ubacite jumper JP1, sa selektorom koji sadrži funkciju neophodnu za zimski period, nama potrebe za dodatnom toplotom.

⚠ Aktiviranjem funkcije se predviđa paljenje gorionika preko procesa simulacije zahtevane toplote grejanja.

Kako bi operacije bile uspešno podešene, postupite po sledećim uputstvima:

- ugascite kotao
- skinite poklopac i dođite do kartice
- ubacite džemper JP1 (sl. 16) kako bi se osposobila dugmad na kontrolnoj tabli sa funkcijama za regulaciju minimalnog i maksimalnog grejanja.
- uverite se da je birač funkcija postavljen na zimski period (pogledajte paragraf 4.2).
- priključite kotao na struju

⚠ **Obratite pažnju na napon električne kartice (230 Volt)**

- okrenite dugme za regulaciju temperature za grejanja vode **B** (sl. 17) sve dok se ne postigne vrednost minimalnog grejanja u tabeli multigas
- ubacite džemper JP2 (sl. 16)
- okrenite dugme za regulaciju temperature sanitarne vode **C** (sl. 17) sve dok se ne postigne maksimalno grejanja kao što je prikazano u tabeli multigas
- otklonite jumper JP2 kako bi se memorisala vrednost maksimalnog grejanja
- **otклонite jumper JP1 kako bi se memorisala minimalna vrednost grejanja i kako bi se završila sa procesom podešavanja**
- ponovo stavite poklopac za ispuštanje vazduha

Isključite merač pritiska i zategnite zavrtanj za testiranje tačke pritiska.

⚠ Kako bi se proces podešavanja završio bez memorisanja postignutih vrednosti, potrebno je raditi na sledeći način:

- postavite birač funkcije na poziciju ⏻ (OFF)
- prekinite napajanje
- otклонiti JP1/JP2

⚠ Funkcije za podešavanje su automatski se zaključavaju bez memorisanja minimalnih i maksimalnih vrednosti za otprilike 15 minuta nakon njihove aktivacije.

⚠ Funkcije su automatski zaključane u slučaju nekog kvara ili blokade.

Čak i u takvom slučaju, onemogućene funkcije NE predviđaju memorisanje vrednosti.

#### Napomena

Kako bi se ispratio proces podešavanja sa samo maksimalnim grejanjem, moguće je otkлонiti jumper JP2 (memorisana samo maksimalna vrednost) i kako bi se uspešno izašlo iz funkcije, bez memorisanja minimalne vrednosti, potrebno je postaviti birač funkcija na poziciju ⏻ (OFF) ili prekinuti napajanje kotla.

⚠ Nakon svake intervencije na podešavanju elemenata ventila gasa, zapečatite ga lakom za pečačenje.

A Završna podešavanja:

- ponovo podesite početnu temperaturu pomoću termostata na željenu
- postavite birač temperature grejanja vode na željenu poziciju
- zatvorite radnu tablu
- ponovo postavite zaštitni poklopac.

#### 4.6 Promena vrste gasa

Promena vrste gasa sa jedne na drugu može se lako izvršiti čak i kada je kotao instaliran.

Kotao je, već po proizvodnji, spreman za rad na prirodni gas (G20) prema naznakama koje su na samom proizvodu.

Postoji mogućnost da se jedan tip kotla koji koristi jedan tip gasa zameni drugim njemu suprotnim i to zahteva komplet:

- komplet za zamenu metana kao prirodnog gasa
- komplet za zamenu GPL

Za ovaj model odnose se instrukcije koje slede:

- ukinite električno napajanje kotla i zatvorite slavinu za dovod gasa
- skinite po sledećem redosledu: ventil za ispuštanje vazduha, a zatim i poklopac za sagorevanje (sl. 19)
- skinite kabl za povezivanje
- skinite metalni deo koji se nalazi ispod dela gde se vazduh zadržava
- skinite zavrtnje sa gorionika i uklonite i ovu poslednju svećicu koja je postavljena kao i priložene kablove
- koristite odgovarajući ključ, skinite sve dizne i zamenite ih postojećim kompletom.

⚠ **Postavite i montirajte precizno dizne koje su sadržane u kompletu za promenu gasa čak i u slučaju da je model bez dizni.**

- ponovo ubacite gorionik u komoru za sagorevanje i zavrtnite zavrtnje i fiksirajte ih za akumulaciju gasa
- postavite zaštitnu kutiju sa kablom svećice na njihovo mesto gde se zadržava vazduh
- ponovo priključite kabl za svećice
- ponovo postavite zaštitni poklopac u komori za sagorevanje kao i zaštitni ventil za zadržavanje vazduha
- ponovo aktivirajte kontrolnu tablu prema prednjoj strani kotla
- otvorite poklopac kartice
- na kontrolnoj kartici (sl. 16):
  - ukoliko se radi o zameni prirodnog gasa, GPL gasom onda to znači da treba ubaciti jednu metalnu konstrukciju u poziciji JP3
  - ukoliko se radi o zameni GPL gasa metanom, onda tu istu konstrukciju treba skinuti sa pozicije JP3
- ponovo rasporedite komponente koje su prethodno bile uklonjene
- ponovo uključite napajanje i ponovo otvorite slavinu za dovod gasa (sa kotlom koji je u upotrebi, treba proveriti sadržaj kao i protok gasa).

⚠ **Ovakva zamena treba da bude izvršena od strane stručnog lica.**

⚠ **Nakon što je završena zamena, potrebno je ponovo podesiti kotao prateći ono što je naznačeno u specifičnom odeljku kao i što treba primeniti za identifikaciju sadržaja kompleta.**

## 5 ODRŽAVANJE

Kako bi osigurali dugoročnije funkcionalne karakteristike i efikasnost proizvoda i kako bi se ispoštovale potrebe zakonodavstva, potrebno je raditi povremene sistematske provere.

Učestalost kontrola zavise od pojedinih uslova instalacije i korišćenja ali je ipak, potrebna kontrola na godišnjem nivou od strane ovlašćenih lica Tehničkog servisa.

Isključite uređaj da biste izvršili održavanje strukture blizu konekcija izduva dimnog gasa i njenog dodatnog pribora. Kada se intervencije završe, kvalifikovani tehničar mora proveriti da cevi i uređaji funkcionišu pravilno.

**VAŽNO:** pre nego što preduzmete bilo kakav korak za održavanje i čišćenje aparature pritisnite dugme za prekid rada istog aparata, prekinite dovod struje, dovod gasa pritiskajući slavinu smeštenu na kotlu.

Ne čistite aparaturu niti njene delove zapaljivim materijama (npr. benzin, alkohol, itd.).

Ne treba čistiti delove radne table kao ni plastične delove.

Radna tabla se može očistiti samo sapunicom i vodom.

### 5.1 Provera parametara sagorevanja

**Ciao S C.S.I.:**

Za preuzimanje analiza sagorevanja potrebno je slediti sledeća uputstva:

- otvorite ventil sa toplom vodom maksimalne protočnosti
- podesite birač funkcija na leto ☀ i podesite temperaturu sanitarne vode na maksimalnu vrednost (sl. 8a).
- sklonite zavrtnje sa zaštitnog poklopca pri analizi sagorevanja (sl. 18) i umesto toga ubacite sondu
- priključite kotao na struju

**Ciao S R.S.I.:**

- ugascite kotao
- postavite birač funkcije na funkciju zime
- skinite poklopac i dođite do kartice
- umetnite jumpere JP1 i JP2
- upotrebite odvijač da biste izvadili čep koji se nalazi na komandnoj tabli
- dovedite do maksimalne vrednosti trimer P2 koristeći odvijač (okretati u smeru kazaljke na satu)
- sklonite zavrtnje sa zaštitnog poklopca pri analizi sagorevanja (sl. 18) i umesto toga ubacite sondu
- priključite kotao na struju

Aparat funkcioniše sa maksimalnom snagom i moguće je podesiti kontrolu nad sagorevanjem.

Sada je analiza završena:

- treba zatvoriti slavinu sa toplom vodom
- pomerite sondu od analizatora i zatvorite poklopac na gorioniku fiksirajući tada zavrtnje koji treba da ostanu nepomični.



## KORISNIK

### 1A OPŠTA UPOZORENJA I BEZBEDNOST

Priručnik za ručnu upotrebu je sastavni deo proizvoda i zbog toga mora pažljivo da se koristi i da se prate uputstva pri svakom kontaktu sa proizvodom; u slučaju gubitka ili oštećenja uputstva može se zahtevati drugi primerak od Tehničkog servisa.

- ⚠ Montażu, popravku ili bilo koju drugu intervenciju treba da obavi stručno lice u saglasnosti sa nacionalnim i lokalnim propisima.
- ⚠ Da bi se proizvod instalirao potrebno je obratiti se stručnom osoblju.
- ⚠ Kotao se mora koristiti isključivo za onu namenu koju je predvideo proizvođač. Isključuje se bilo kakva ugovorna ili van ugovorna odgovornost zbog šteta koje su prouzrokovale osebe, životinje ili stvari, zbog grešaka u montaži, podešavanju, održavanju ili usled nepravilnog korišćenja.
- ⚠ Sigurnosni elementi ili elementi automatske regulacije uređaja ne smeju se menjati tokom životnog veka uređaja, osim ako to ne učini proizvođač ili dobavljač.
- ⚠ Ovaj proizvod služi da proizvede toplu vodu i zbog toga mora biti u skladu sa garancijom/uslovima o grejanju ili u skladu sa mrežnom distribucijom sanitarne tople vode kao i što mora biti usaglašen sa svim svojim potencijalima.
- ⚠ U slučaju da curi voda, zatvorite dugme za napajanje i punjenje vode i obavestite Tehnički servis.
- ⚠ U slučaju dužeg odsustva zatvorite dovod gasa i glavnim prekidačem isključite električno napajanje. Ako se predviđa mogućnost smrzavanja, ispustite vodu iz kotla.
- ⚠ Proverite s vremena na vreme da pritisak prema priloženim hidrauličkim uputstvima ne padne ispod vrednosti od 1 bar-a.
- ⚠ U slučaju oštećenja ili lošeg funkcionisanja aparata potrebno je deaktivirati ga i držati se dalje od bilo kakvog pokušaja popravke ili direktne intervencije.
- ⚠ Održavanje aparata mora se raditi bar jednom godišnje: programirati aparat na vreme sa Tehničkim servisom značilo bi sprečavanje troškova i vremena.

Korišćenje kotla zahteva i posebno obraćanje pažnje na neka osnovna sigurnosna pravila:

- Ne koristiti aparat u druge svrhe osim za one za koje je namenjen.
- Opasno je dirati aparat ili biti u kontaktu sa aparatom ukoliko je telo vlažno a noge bose.
- Najstrože je zabranjeno začepljivati krpama, papirom ili drugim usisne rešetke i otvor za provetranje prostorije u kojoj je postavljen uređaj.
- Upozoravajući miris gasa znači da ne radite apsolutno ništa na elektronskim prekidačima i bilo kom drugom predmetu koji može prouzrokovati varničenje. Proveriti prostorije tako što ćete otvoriti vrata i prozore a zatvoriti slavinu sa centralnim gasom.
- Ne stavljati nikakve predmete na kotao.
- Ne preporučljivo je bilo kakvo čišćenje pre nego što se aparat isključi iz mreže napajanja električnom energijom.
- Nemojte začepljivati ili smanjivati dimenzije otvora za provetranje prostorije u kojoj je postavljen uređaj.
- Nemojte ostavljati kutije ili zapaljive materije u prostoriji u kojoj je instaliran aparat.
- Nepreporučljivo je pokušavati popraviti neki nedostatak i/ili loše funkcionisanje aparata.
- Opasno je vući i izvlačiti električne kablove.
- Nepreporučljivo je da aparatom upravljaju deca.
- Zabranjeno je intervenisanje na elementima koji su zapečaćeni.

Kako bi upotreba prošla najbezbednije, treba obratiti pažnju na sledeće:

- treba čistiti aparat sa spoljne strane sapunicom i vodom i osim što estetski bolje izgleda takođe sprečava koroziju i samim tim produžavate vek proizvodu;
- u slučaju kada je kotao okačen na zid on nije više prenosiv, i treba tada ostaviti prostor od 5 cm sa strane kako bi se obezbedilo lakše održavanje;
- instalacija termostata će osećaj komfora podići na određeni nivo, to je osnova za najracionalnije zagrevanje i tako će se i energija uštedeti; rad kotla takođe može da bude potpomognut programskim satom radi boljeg upravljanja za funkcije paljenja i gašenja u toku dana ili sedmice.

### 2A UKLJUČIVANJE

Prvo uključivanje kotla mora biti izvršeno i podešeno od strane Tehničkog servisa. A takođe je neophodno i staviti aparat na testiranje, propratiti pažljivo opisane radnje.

Da biste uključili kotao, neophodno je da uradite sledeće operacije:

- priključite kotao na struju
- otvorite slavinu za dovod gasa koja se nalazi na uređaju, da biste omogućili paljenje
- okrenite birač funkcija (1 - sl. 1a) u željeni položaj:

#### Ciao S C.S.I.:

**Leto:** okrenite birač na simbol leto ☀ (sl. 2a) aktivira se funkcija samo za toplu sanitarnu vodu. Ako postoji zahtev za toplom vodom digitalni displej prikazuje temperaturu sistema tople vode, ikonu da bi naznačio dovod tople vode i ikonu plamena

**Zima:** okretanjem birača funkcije u okviru zone obeležene + i - (sl. 2b), kotao obezbeđuje sanitarnu vodu i grejanje. Ako postoji zahtev za grejanjem, kotao se uključuje i digitalni monitor prikazuje temperaturu vode za grejanje, ikonu grejanja i ikonu plamena (sl. 3a). Ako postoji zahtev za sanitarnom vodom, kotao se uključuje i digitalni displej prikazuje temperaturu sistema tople vode, ikonu za dovod tople vode i ikonu plamen (sl. 4a)

**Predzagrevanje** (brzo zagrevanje vode): rotirajte dugme za podešavanje temperature vruće vode (2 - sl. 1a) do ☺ simbola (sl. 5a), da biste aktivirali funkciju predzagrevanja. Ova opciju omogućava da se održi topla voda što omogućuje izmenjivač sanitarne vode i smanjuje vreme čekanja. Kada se aktivira funkcija predzagrevanja, monitor prikazuje temperaturu dovoda vode za grejanje ili sanitarne vode, u skladu sa trenutnim zahtevom. Tokom paljenja koje prati predzagrevanje, ekran pokazuje P simbol (sl. 5b). Kako biste deaktivirali opciju predzagrevanja, potrebno je da vratite dugme za podešavanje temperature vruće vode na ☺ simbol. Vratiti dugme za ručno podešavanje temperature sanitarne vode na željenu poziciju. Funkcija nije aktivna kada je kotao na OFF: birač funkcije (1 sl.1a) na ⏻ OFF.

#### Ciao S R.S.I.:

**Letnji režim (samo sa povezanim spoljnim rezervoarom za vodu):** okrećući birač na simbol leto ☀ (sl. 2a) aktivira se tradicionalna funkcija sanitarne tople vode i kotao će se aktivirati na temperaturi postavljenoj na spoljnom aparatu za prokuvavanje. If Ako postoji zahtev za toplom vodom digitalni displej prikazuje temperaturu sistema tople vode, ikonu da bi naznačio dovod tople vode i ikonu plamena

**Zima:** okretanjem birača funkcije u okviru zone označene + i - (sl. 2b), kotao obezbeđuje toplu vodu za grejanje i - ako je povezan sa spoljnim aparatom za prokuvavanje - sanitarnu toplu vodu. Ako postoji zahtev za grejanjem, kotao se uključuje i digitalni monitor prikazuje temperaturu vode za grejanje, ikonu grejanja i ikonu plamena (sl. 3a). Ako postoji zahtev za sanitarnom vodom, kotao se uključuje i digitalni displej prikazuje temperaturu sistema tople vode, ikonu za dovod tople vode i ikonu plamen (sl. 4a).

Postavite sobni termostat na željenu temperaturu (~20°C)

#### Ciao S C.S.I.: Podešavanje temperature sanitarne vode

Da biste regulisali temperaturu sanitarne tople vode (kupačila, tuševi, kuhinja, itd.), okrenite dugme sa simbolom ☀ (sl. 2b) u okviru zone označene + i -.

Kotao je u stanju pripreme dok se gorionik ne uključi zbog zahteva za toplom vodom i digitalni displej prikazuje temperaturu sistema tople vode, ikonu dovoda tople vode i ikonu plamena

Kotao će biti u funkciji dok se ne postignu željene temperature, posle čega će ponovo biti u stanju "stand-by".

Ukoliko se uključi led crvene boje blizu simbola ⚠ na kontrolnoj tabli, to znači da je kotao u stanju privremenog zastoja rada (potrebno je videti odeljak sa svetlećom signalizacijom i kvarovima). Na digitalnom displeju se prikazuje kod određenog kvara (sl. 6a).

#### Ciao S R.S.I.: Podešavanje temperature sanitarne vode

**CASE A** samo grejanje - podešavanje se ne primenjuje

**SLUČAJ B** samo zagrevanje + spoljašnji bojler sa termostatom – regulacija nije primenljiva.

**SLUČAJ C** samo grejanje + spoljni rezervoar sa sondom – da biste podesili temperaturu sanitarne tople vode u rezervoaru, okrenite prekidač – ali, sa simbolom u smeru kazaljke na satu za povećavanje temperature vode i u smeru suprotnom od kazaljke na satu za smanjivanje.

Kotao je u stanju pripreme dok se gorionik ne uključi zbog zahteva za toplom vodom i digitalni displej pokazuje temperaturu sistema tople vode, ikonu dovoda tople vode i ikonu plamena. Kotao će biti u funkciji dok se ne postignu željene temperature, posle čega će ponovo biti u stanju "stand-by".

Ukoliko se uključi led crvene boje blizu simbola  na kontrolnoj tabli, to znači da je kotao u stanju privremenog zastoja rada (potrebno je videti odeljak sa svetlećom signalizacijom i kvarovima). Na digitalnom displeju se prikazuje kod određenog kvara (sl. 6a)

### Ciao S C.S.I. - Ciao S R.S.I.: Funkcija za automatski sistem za regulaciju (S.A.R.A.) sl. 7a

Postavljanjem birača temperature za grejanje vode u delu na kojem piše AUTO - vrednost temperature od 55 do 65°C - aktivira se sistem samoregulisanja S.A.R.A.: Kotao menja izlaznu temperaturu vode zavisno od signala zatvaranja sobnog termostata. Kad se postigne nameštena temperatura pomoću birača za grejanje vode, počinje odbrojavanje od 20 minuta. Ako u toku ovog perioda sobni termostat i dalje bude tražio dovod toplote, nameštena vrednost temperature će se automatski podignuti za 5 °C.

Kada je dostignuta nova vrednost, počinje još jedno odbrojavanje od 20 minuta.

Ako tokom ovog perioda, spoljni termostat i dalje zahteva zagrevanje, vrednost podešene temperature se automatski povećava za 5 °C. Ova nova početna vrednost temperature je rezultat ručnog podešavanja temperature grejanja vode i porasta temperature vode od +10 °C funkcije S.A.R.A.



Nakon drugog ciklusa vrednost temperature bi trebalo držati na postavljenoj vrednosti +10°C dok se ne zadovolji zahtev sobnog termostata.

## 3A ISKLJUČIVANJE

### Privremeno isključivanje

U slučaju kraćeg odsustva postavite birač funkcije (1 - sl. 1a) u položaj  (OFF).

Na ovaj način ostavljajući aktivno električno napajanje i dovod goriva, kotao je zaštićen sistemima:

- **Uređaj protiv zamrzavanja:** kada je temperatura vode u kotlu ispod 5°C aktivira se cirkulaciona pumpa a, ukoliko je potrebno, i gorionik sa minimalnom snagom kako bi se temperatura vode povratila na sigurne vrednosti (35°C). Tokom ciklusa protiv zamrzavanja na digitalnom displeju se pojavljuje simbol  na digitalnom monitoru.
- **Funkcija protiv blokade cirkulacione pumpe:** ciklus rada se aktivira na svaka 24 sata.
- **Sanitarni antifriz (samo kada je povezan na spoljni rezervoar sa sondom):** funkcija se aktivira ukoliko izlazna temperatura sonde bojlera padne ispod 5°C. U toj fazi nastaje toplotni zahtev sa paljenjem gorionika sa minimalnom snagom, koja se održava sve dok izlazna temperatura vode ne dostigne 55°C. Tokom ciklusa protiv zamrzavanja na digitalnom monitoru se pojavljuje simbol .

### Isključivanja na duže vreme

U slučaju dužeg odsustva postavite birač funkcije (1 - sl. 1a) u položaj  (OFF).

Zatvorite zatim slavinu za dovod gasa smeštenu iznad kotla. U ovom slučaju funkcija zaštite od smrzavanja je deaktivirana: ispraznite vodu iz instalacije ako postoji rizik od smrzavanja.

## 4A KONTROLE























Proverite na početku grejne sezone i povremeno tokom korišćenja, očitavaju li se na hidrometru-termohidrometru, dok je instalacija hladna, vrednosti pritiska između 0,6 i 1,5 bar: zato je neophodno izbegavati bilo kakvo izlaganje oštećenju proizvoda gde je potrebno prisustvo vazduha. U slučaju da je nedovoljna cirkulacija vode kotao se gasi. Ni u kom slučaju pritisak vode ne sme da bude niži od 0,5 bar (oznaka crvenog signalnog polja).

U slučaju da se ovi uslovi verifikuju potrebno je ponovo pustiti pritisak vode u kotao kao što je dole opisano:



- postavite birač funkcije (2 - sl. 1a) na  (OFF)
- okrećite slavinu za punjenje (L sl. 13 za C.S.I. - eksterna za R.S.I.) dok pritisak ne bude između 1 i 1,5 bara.
- Ponovo zatvorite slavinu pažljivo.
- Ponovo postavite birač funkcije u početnu poziciju.
- Ukoliko je pad pritiska znan obratite se Tehničkom servisu.

## 5A SVETLOSNA SIGNALIZACIJA I NEPRAVILNOSTI

Lo stato di funzionamento della caldaia è indicato dal visualizzatore digitale, di seguito elenchiamo le tipologie di visualizzazione.

STATUS KOTLA	DISPLEJ
Mirovanje	-
OFF status	OFF
Alarm zaključavanja ACF modula	A01  
Alarm električnog kvara ACF	A01  
Alarm graničnog termostata	A02 
Alarm vazdušnog presostata	A03 
Alarm vodenog presostata	A04  
Kvar NTC sanitarne vode (C.S.I. i R.S.I samo sa eksternim grejačem rezervoara i sondom)	A06 
Kvar NTC grejanja	A07 
Parazitski plamen	A11 
Električna kalibracija minimalnog i maksimalnog grejanja	ADJ 
Prelazno stanje u očekivanju uključivanja	88°C 
Intervencija vazdušnog presostata	 treptanje
Intervencija vodenog presostata	  treptanje
Aktivna funkcija predzagrevanja (samo C.S.I.)	P
Zahtev za zagrevanjem predzagrevanja (samo C.S.I.)	P  treptće
Eksterna sonda prisutna	
Zahtev za grejanjem sanitarne vode	60°C 
Zahtev za grejanjem	80°C 
Zahtev za grejanjem antifrizu	
Plamen prisutan	

### Da biste ponovo uspostavili funkcionisanje (deblokada alarma): Kvarovi A 01-02-03



Postavite birač funkcije na isključeno  (OFF), sačekajte 5-6 sekundi i ponovo vratite na željenu poziciju  (leto) ili  (zima). Ukoliko postupci koje ste primenili nisu reaktivirali kotao potrebno je pozvati tehničku podršku.

### Kvarovi A 04

Na digitalnom displeju pored koda za kvar, je simbol .

Utvrđiti vrednost pritiska prikazanu na hidrometru:

ako je niža od 0,3 bara, postavite birač funkcije na  (OFF) i podesite slavinu za punjenje (L sl. 13 za C.S.I. - eksterna za R.S.I.) dok pritisak ne postigne vrednost između 1 i 1,5 bara.

Postavite birač funkcije na željenu poziciju  (leto) ili  (zima). Kotao će obaviti jedan ciklus ozračivanja u trajanju od oko 2 minuta. Ukoliko je pad pritiska vode česta pojava obratite se našoj tehničkoj podršci.

### Kvar A 06 (samo C.S.I.)

Kotao normalno radi, ali ne garantuje stabilnost temperature sanitarne vode koja ostaje podešena približno na temperaturu oko 50°C. POTREBNA je intervencija servisa.

### Kvarovi A 07

Obratiti se Servisu za tehničku podršku.

## TEHNIČKI PODACI

OPIS		CIAO 20 S C.S.I.	CIAO 24 S C.S.I.	CIAO 24 S R.S.I.
<b>Grejanje</b>	Toplotno opterećenje	kW	22,20	25,80
		kcal/h	19.092	22.188
	Maksimalna termička snaga	kW	20,60	23,94
		kcal/h	17.717	20.590
	Minimalno toplotno opterećenje	kW	7,00	8,90
		kcal/h	6.020	7.654
Minimalna termička snaga	kW	5,88	7,61	
	kcal/h	5.057	6.544	
<b>Sanitarna topla voda</b>	Toplotno opterećenje	kW	22,20	25,80
		kcal/h	19.092	22.188
	Maksimalna termička snaga	kW	20,60	23,94
		kcal/h	17.717	20.590
	Minimalno toplotno opterećenje	kW	7,00	8,90
		kcal/h	6.020	7.654
Minimalna termička snaga	kW	5,88	7,61	
	kcal/h	5.057	6.544	
Stepen iskorišćenja Pn maks - Pn min	%	92,8 - 84,0	92,8 - 85,5	92,8 - 85,5
Efikasnost 30% (47° povratni vod)	%	91,9	90,9	90,9
Iskorišćenost sagorevanja	%	93,2	93,0	93,0
Električna snaga	W	100	116	116
Kategorija		II2H3+	II2H3+	II2H3+
Zemlja odredišta **		-	-	-
Napon napajanja	V - Hz	230-50	230-50	230-50
Nivo zaštite	IP	X5D	X5D	X5D
Gubici na dimnjaku sa uključenim gorionikom	%	6,85	6,96	6,96
Gubici na dimnjaku sa isključenim gorionikom	%	0,09	0,07	0,07
<b>Uvođenje grejanja</b>				
Pritisak - Maksimalna temperatura	bar-°C	3 - 90	3 - 90	3 - 90
Minimalni pritisak za pravilan rad	bar	0,25 - 0,45	0,25 - 0,45	0,25 - 0,45
Polje za biranje temperature za grejanje H2O	°C	40/80	40/80	40/80
Pumpa: raspoloživi napor	mbar	300	300	300
protok	l/h	1.000	1.000	1.000
Ekspanziona posuda	l	7	8	8
Pritisak u ekspanzionoj posudi	bar	1	1	1
<b>Sanitarni režim</b>				
Maksimalni pritisak	bar	6	6	-
Minimalni pritisak	bar	0,15	0,15	-
Količina tople vode na $\Delta t$ 25°C	l/min	11,8	13,7	-
na $\Delta t$ 30 °C	l/min	9,8	11,4	-
na $\Delta t$ 35 °C	l/min	8,4	9,8	-
Minimalna protok sanitarne vode	l/min	2	2	-
Polje za biranje temperature za sanitarnu H2O	°C	37/60	37/60	-
Regulator protoka	l/min	8	10	-
<b>Pritisak gasa</b>				
Normalni pritisak prirodnog gasa (G20)	mbar	20	20	20
Nominalni pritisak tečnog gasa G.P.L. (G30/G31)	mbar	28-30/37	28-30/37	28-30/37
<b>Hidraulično povezivanje</b>				
Ulaz - izlaz grejanja	Ø	3/4"	3/4"	3/4"
Ulaz - izlaz sanitarne vode	Ø	1/2"	1/2"	-
Ulaz - izlaz sanitarne vode	Ø	-	-	3/4"
Ulaz gasa	Ø	3/4"	3/4"	3/4"
<b>Dimenzije kotla</b>				
Visina	mm	715	715	715
Širina	mm	405	405	405
Dubina sa maskom	mm	248	248	248
Težina kotla	kg	29	31	28
<b>Protoci (G20)</b>				
Protok vazduha	Nm <sup>3</sup> /h	36,875	39,613	39,613
Protok dimnih gasova	Nm <sup>3</sup> /h	39,101	42,204	42,204
Protok dimnih gasova (maks-min)	gr/s	13,310 - 14,540	14,308 - 16,247	14,308 - 16,247
<b>Protoci (G20)</b>				
Protok vazduha	Nm <sup>3</sup> /h	35,328	40,249	40,249
Protok dimnih gasova	Nm <sup>3</sup> /h	36,955	41,008	41,008
Protok dimnih gasova (maks-min)	gr/s	13,100 - 14,030	13,985 - 16,429	13,985 - 16,429

\*\* Instalacija ovog proizvoda je dozvoljena samo u državama navedenim na natpisnoj pločici, bez obzira na ovaj jezik prevoda.

OPIS		CIAO 20 S C.S.I.	CIAO 24 S C.S.I.	CIAO 24 S R.S.I.
<b>Protoci (G31)</b>				
Protok vazduha	Nm <sup>3</sup> /h	36,405	40,454	40,454
Protok dimnih gasova	Nm <sup>3</sup> /h	38,119	41,455	41,455
Protok dimnih gasova (maks-min)	gr/s	13,480 - 14,280	14,120 - 16,683	14,120 - 16,683
<b>Karakteristike ventilatora</b>				
Preostali napor kotao bez cevi	Pa	43	110	110
<b>Koncentrične cevi za odvod dimnih gasova</b>				
Prečnik	mm	60-100	60 - 100	60 - 100
Maksimalna dužina	m	4,25	4,25	4,25
Gubitak pri ubacivanju cevi od 45°/90°	m	1 - 1,5	1 - 1,5	1 - 1,5
Otvor kroz zid (prečnik)	mm	105	105	105
<b>Koncentrične cevi za odvod dimnih gasova</b>				
Prečnik	mm	80-125	80-125	80-125
Maksimalna dužina	m	12,40	12,4	12,4
Gubitak pri ubacivanju cevi od 45°/90°	m	1,35 - 2,2	1,35 - 2,2	1,35 - 2,2
Otvor kroz zid (prečnik)	mm	130	130	130
<b>Koncentrične cevi za odvod dimnih gasova</b>				
Prečnik	mm	80	80	80
Maksimalna dužina	m	10 + 10	16 + 16	16 + 16
Gubitak pri ubacivanju cevi od 45°/90°	m	1,2 - 1,7	1,2 - 1,7	1,2 - 1,7
<b>Instalacija B22P-B52P</b>				
Prečnik	mm	80	80	80
Maksimalna dužina odvoda	m	14	25	25
Klasa NOx		3	3	3
<b>Vrednosti emisije pri maksimalnom i minimalnom protoku gasa G20*</b>				
Maksimum - Minimum CO s.a. manji od	ppm	100 - 180	120 - 200	120 - 200
CO <sub>2</sub>	%	7,1 - 2,0	7,3 - 2,2	7,3 - 2,2
NOx s.a. niži od	ppm	180 - 100	200 - 100	200 - 100
Temperatura u dimovodnoj cevi	°C	127 - 97	142 - 109	142 - 109

\* Provera izvršena pomoću koaksijalne cevi Ø 60-100 - dužina 0,85 m - temperatura vode 80-60°C

### Tabela multigas

OPIS		Prirodni gas (G20)			Butan (G30)			Propan (G31)		
		20 S C.S.I.	24 S C.S.I.	24 S R.S.I.	20 S C.S.I.	24 S C.S.I.	24 S R.S.I.	20 S C.S.I.	24 S C.S.I.	24 S R.S.I.
Wobbe indeks manji (od 15°C-1013 mbar)	MJ/m <sup>3</sup> S	45,67			80,58			70,69		
Mogućnost korišćenja niže vrednosti toplote	MJ/m <sup>3</sup> S	34,02			116,09			88		
Nominalna vrednost pritiska pri zagrevanju	mbar (mm W.C.)	20 (203,9)			28 - 30 (285,5 - 305,9)			37 (377,3)		
Minimalna vrednost pritiska pri zagrevanju	mbar (mm W.C.)	13,5 (137,7)			-			-		
Gorionik broj otvora	n°	11			11			11		
Gorionik prečnik otvora	mm	1,30	1,35	1,35	0,75	0,78	0,78	0,75	0,78	0,78
Maksimalni protok gasa za grejanje	Sm <sup>3</sup> /h	2,35	2,73	2,73						
	kg/h				1,75	2,03	2,03	1,72	2,00	2,00
Maksimalni protok gasa za sanitarnu funkciju	Sm <sup>3</sup> /h	2,35	2,73	-						
	kg/h				1,75	2,03	-	1,72	2,00	-
Minimalni protok gasa za grejanje	Sm <sup>3</sup> /h	0,74	0,94	0,94						
	kg/h				0,55	0,70	0,70	0,54	0,69	0,69
Minimalni protok gasa za sanitarnu funkciju	Sm <sup>3</sup> /h	0,74	0,94	-						
	kg/h				0,55	0,70	-	0,54	0,69	-
Maksimalni pritisak iza ventila za grejanje	mbar	10,40	11,80	11,80	28,00	27,80	27,80	36,00	35,80	35,80
	mm W.C.	106,05	120,33	120,33	285,52	283,48	283,48	367,10	365,06	365,06
Maksimalni pritisak iza ventila za sanitarnu funkciju	mbar	10,40	11,80	-	28,00	27,80	-	36,00	35,80	-
	mm W.C.	106,05	120,33	-	285,52	283,48	-	367,10	365,06	-
Minimalni pritisak iza ventila za grejanje	mbar	1,20	1,50	1,50	3,00	3,30	3,30	3,90	4,30	4,30
	mm W.C.	12,24	15,30	15,30	30,59	33,65	33,65	39,77	43,85	43,85
Minimalni pritisak iza ventila za sanitarnu funkciju	mbar	1,20	1,50	-	3,00	3,30	-	3,90	4,30	-
	mm W.C.	12,24	15,30	-	30,59	33,65	-	39,77	43,85	-

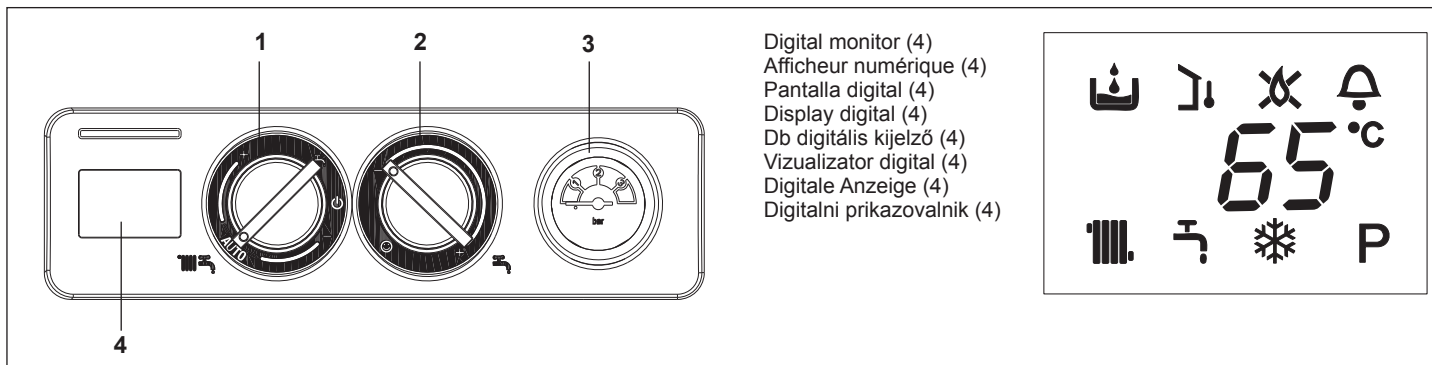

Digital monitor (4)  
 Afficheur numérique (4)  
 Pantalla digital (4)  
 Display digital (4)  
 Db digitális kijelző (4)  
 Vizualizator digital (4)  
 Digitale Anzeige (4)  
 Digitalni prikazovalnik (4)



**[EN] Control panel**

- 1 Mode selector: Off/Alarm reset, Summer, Winter/Heating water temperature adjustment
- 2 Domestic hot water temperature adjustment  
 Pre-heating function (faster hot water) (only for C.S.I. models)
- 3 Hydrometer
- 4 Digital monitor indicating the operating temperature and irregularity codes

Description of the icons

- System loading - this icon is visualised together with irregularity code A 04
- Heat-adjustment: indicates the connection to an external probe
- Flame failure - this icon is visualised together with irregularity code A 01
- Irregularity: indicates any operating irregularities, together with an alarm code
- Heating operation
- Domestic hot water operation
- Anti-freeze: indicates that the anti-freeze cycle has been activated
- Pre-heating (faster hot water): indicates that a pre-heating cycle has been activated (the burner is ON) (only for C.S.I. models)
- 65° Heating/domestic hot water temperature or operating irregularity

**[F] Panneau de commande**

- 1 Sélecteur de fonction : Éteint (OFF)/Réarmement des alarmes, Été, Hiver/Réglage de la température de l'eau du chauffage
- 2 Réglage de la température de l'eau sanitaire  
 Fonction préchauffage (eau chaude plus rapidement) (uniquement pour les modèles C.S.I.)
- 3 Hydromètre
- 4 Afficheur numérique qui signale la température de fonctionnement et les codes d'anomalie

Description des icônes

- Chargement du système: cette icône est affichée avec le code d'anomalie A 04
- Régulation thermique: cette icône indique la connexion à une sonde extérieure
- Blocage de flamme: cette icône est affichée avec le code d'anomalie A 01
- Anomalie: cette icône indique une quelconque anomalie de fonctionnement et est affichée avec un code d'alarme
- Fonctionnement en mode chauffage
- Fonctionnement en mode sanitaire
- Antigel : cette icône indique que le cycle antigel
- Préchauffage (eau chaude plus rapidement) est en cours : cela indique que un cycle de préchauffage est en cours (le brûleur est allumé) (uniquement les modèles C.S.I.)
- 65° Température en mode chauffage/sanitaire ou anomalie de fonctionnement

**[ES] Panel de mandos**

- 1 Selector de función: Apagado (OFF)/Reset alarmas, Verano, Invierno/Regulación temperatura agua calefacción
- 2 Regulación de la temperatura agua sanitaria  
 Función precalentamiento (agua caliente más rápido) (sólo para modelos C.S.I.)
- 3 Hidrómetro
- 4 Pantalla digital que indica la temperatura de funcionamiento y los códigos de anomalía

Descripción de los iconos

- Carga de la instalación, este icono se visualiza junto con el código de la anomalía A 04
- Termorregulación: indica la conexión a una sonda exterior
- Bloqueo de la llama, este icono se visualiza junto con el código de la anomalía A 01
- Anomalía: indica cualquier anomalía de funcionamiento y se visualiza junto con un código de alarma
- Funcionamiento en modo calentamiento
- Funcionamiento en modo sanitario
- Anticongelante: indica que el ciclo anticongelante está funcionando
- Precalentamiento (agua caliente más rápido): indica que el ciclo de precalentamiento está en curso (el quemador está encendido) (sólo para modelos C.S.I.)
- 65° Temperatura calentamiento/sanitario o bien anomalía de funcionamiento





**[PT] Painel de comando**

- 1 Selector de função: Desligado (OFF)/Reset alarmas, Verão, Inverno/Regulação da temperatura água aquecimento
- 2 Regulação da temperatura água sanitário  
 Função préaquecimento (água quente mais rápida) (apenas para modelos C.S.I.)
- 3 Hidrómetro
- 4 Display digital que sinaliza a temperatura de funcionamento e os códigos de anomalia







Descrição dos ícones

- Carregamento da instalação, este ícone é exibido junto com o código de anomalia A 04
- Termo-regulação: indica a conexão à uma sonda externa
- Bloqueio da chama, este ícone é exibido junto com o código de anomalia A 01
- Anomalia: indica uma anomalia de funcionamento qualquer e é exibida junto com um código de alarme de
- Funcionamento em aquecimento
- Funcionamento em sanitário
- Anti-congelante: indica que está em curso o ciclo anti-congelante
- Pré-aquecimento (água quente mais rápida): indica que está em curso um ciclo de pré-aquecimento (o queimador está ligado) (apenas para modelos C.S.I.)
- 65° Temperatura aquecimento/sanitário ou anomalia de funcionamento





## [SRB] F Kontrolna tabla

- 1 Birač funkcija
  -  Isključeno (OFF)/Resetujte alarm, Leto,
  -  Zima/Podesite temperaturu zagrevanje vode
- 2  Podesite temperaturu sanitarne vode  
 Funkcija prethodnog zagrevanja vode (voda se brže zagreva) (samo za modele C.S.I.)
- 3 Hidrometar
- 4 Na digitalnom displeju se pokazuje temperatura rada kao i određeni kvarovi









### Opis ikone

-  Uređaj je opterećen i tada će ova ikona da bude označena kao kvar koji je kodiran šifrom kvara A 04
-  Termoregulacija: pokazuje spajanje preko spoljne sonde
-  Plamen je blokiran i tada će ova ikona da bude označena kao kvar koji je kodiran šifrom kvara A 01
-  Kvar: predstavlja bilo kakvu vrstu kvara koji se svakako prikazuje zajedno sa kodiranim alarmom koji na te anomalije reaguje bilo da je u pitanju
-  Funkcija zagrevanja vode ili Sanitarna funkcija vode
-  Antifriz: ukazuje da je ciklus antifriz u toku u periodu
-  Prethodnog zagrevanja vode (voda se brže zagreva): ukazuje na to da je u toku ciklus predzagrevanja (gorionik je upaljen) (samo za modele C.S.I.)
- 65° Temperatura zagrevanja vode/sanitarnе vode ili postoji određeni kvar pri funkciji

## [TR] Kontrol paneli

- 1 Mod seçici:
  -  Kapat/Alarm sıfırla, Yaz,
  -  Kış/Isıtma suyu sıcaklık ayarlama
- 2  Şebeke sıcak su ısı ayarlama  
 Ön ısıtma fonksiyonu (daha hızlı sıcak su) (sadece C.S.I. modeli)
- 3 Hidrometre
- 4 Çalışma sıcaklığını ve düzensizlik kodlarını gösteren dijital ekran Simge açıklaması

### Simgelerin açıklaması

-  Sistem yüklemesi - bu simge A 04 düzensizlik kodu ile birlikte görülür
-  Isı ayarı: harici bir ölçüm ucuna bağlantıyı gösterir
-  Alev arızası - bu simge A 01 düzensizlik kodu ile birlikte görülür
-  Düzensizlik: alarm kodu ile birlikte birtakım çalışma düzensizliklerini belirtir
-  Isıtma işlemi
-  Şebeke sıcak su işlemi
-  Anti-friz: anti-friz döngüsünün etkin hale geldiğini gösterir
-  Ön ısıtma (daha hızlı sıcak su): ön ısıtma döngüsünün aktif olduğunu (brülör açık) gösterir (sadece C.S.I. modeli)
- 65° Isıtma/şebeke sıcak su ısısı veya işleyiş düzensizliği

## CIAO S C.S.I.

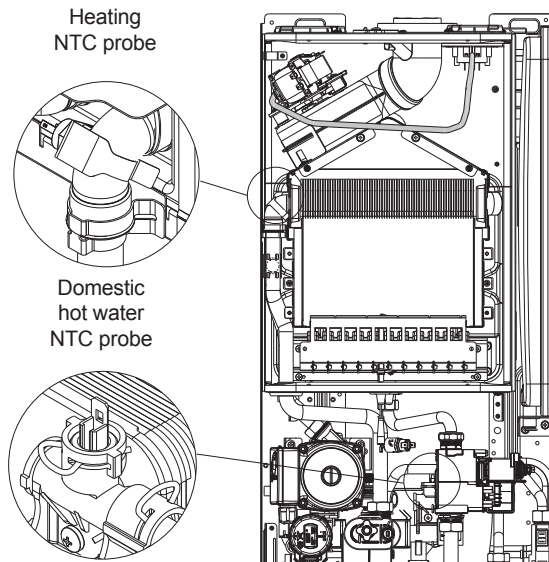
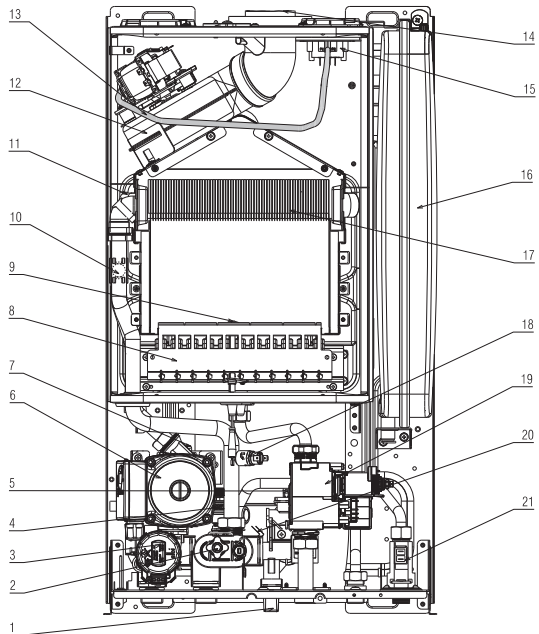

## CIAO S R.S.I.

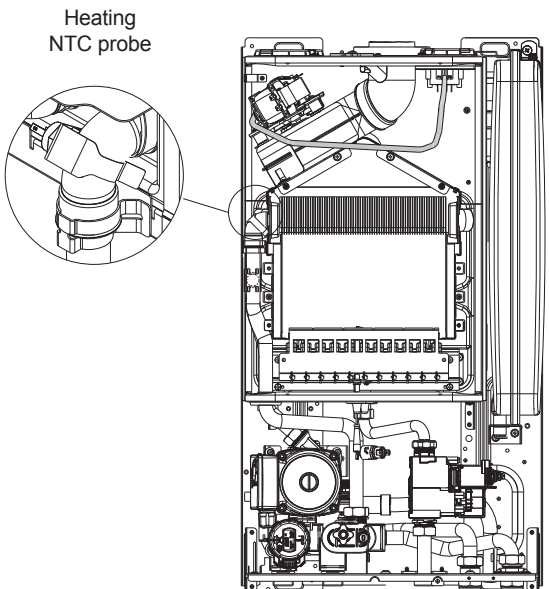
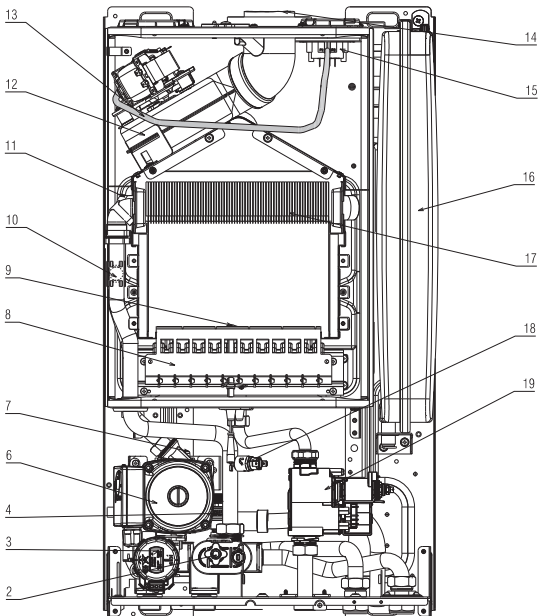

**[EN] BOILER FUNCTIONAL ELEMENTS**

- 1 Filling tap
- 2 Drain tap
- 3 3-way valve
- 4 Safety valve
- 5 Domestic hot water NTC probe
- 6 Circulation pump
- 7 Air vent valve
- 8 Burner
- 9 Flame ignition-detection electrode
- 10 Limit thermostat
- 11 Primary NTC probe
- 12 Fan
- 13 Depression measurement pipe
- 14 Flue gas flange
- 15 Differential flue gas pressure switch
- 16 Expansion tank
- 17 Heat exchanger
- 18 Heating pressure switch
- 19 Gas valve
- 20 Domestic hot water exchanger
- 21 Flow switch

**[F] ÉLÉMENTS FONCTIONNELS DE LA CHAUDIÈRE**

- 1 Robinet de remplissage
- 2 Robinet de vidange
- 3 Vanne à 3 voies
- 4 Soupape de sécurité
- 5 Sonde NTC sanitaire
- 6 Pompe de circulation
- 7 Purgeur d'air
- 8 Brûleur
- 9 Électrode d'allumage-détection de flamme
- 10 Thermostat limite
- 11 Sonde NTC primaire
- 12 Ventilateur
- 13 Tube de détection de dépression
- 14 Bride fumées
- 15 Pressostat différentiel de fumées
- 16 Vase d'expansion
- 17 Échangeur
- 18 Pressostat de chauffage
- 19 Soupape gaz
- 20 Échangeur sanitaire
- 21 Fluxostat

**[ES] ELEMENTOS FUNCIONALES DE LA CALDERA**

- 1 Grifo de llenado
- 2 Grifo de vaciado
- 3 Válvula de 3 vías
- 4 Válvula de seguridad
- 5 Sonda NTC agua sanitaria
- 6 Bomba de circulación
- 7 Válvula de purgado de aire
- 8 Quemador
- 9 Electrodo de encendido-detección llama
- 10 Termostato límite
- 11 Sonda NTC primario
- 12 Ventilador
- 13 Tubo de detección de depresión
- 14 Brida humos
- 15 Presostato diferencial humos
- 16 Vase de expansión
- 17 Intercambiador
- 18 Presostato calefacción
- 19 Válvula gas
- 20 Intercambiador sanitario
- 21 Flusostato

**[PT] ELEMENTOS FUNCIONAIS DA CALDEIRA**

- 1 Válvula de enchimento
- 2 Válvula de descarga
- 3 Válvula 3 vias
- 4 Válvula de segurança
- 5 Sonda NTC sanitário
- 6 Bomba de circulação
- 7 Válvula de desgasificação
- 8 Queimador
- 9 Eléctrodo acendimento-observação da chama
- 10 Termóstato de limite
- 11 Sonda NTC primário
- 12 Ventilador
- 13 Tubo verificação de depressão
- 14 Flange de fumos
- 15 Pressostato fumos diferencial
- 16 Vaso de expansão
- 17 Permutador
- 18 Pressostato de aquecimento
- 19 Válvula do gás
- 20 Intercambiador sanitário
- 21 Fluxostato

**[SRB] FUNKCIONALNI ELEMENTI GASNOG KOTLA**

- 1 Slavina za punjenje
- 2 Slavina za pražnjenje
- 3 Ventil 3 sistemski
- 4 Sigurnosni ventil
- 5 Sanitarna NTC sonda
- 6 Cirkulaciona pumpa
- 7 Ventil za ispušt vazduha
- 8 Gorionik
- 9 Elektroda paljenja-kontrola plamena
- 10 Granični termostat
- 11 Primarna NTC sonda
- 12 Ventilator
- 13 Cevčica za očitavanje pod pritiska
- 14 Prsten
- 15 Diferencijalni merač pritiska vazduha
- 16 Ekspanziona posuda
- 17 Bitermički izmenjivač
- 18 Vodeni presostat
- 19 Ventil za gas
- 20 Izmenjivač sanitarne vode
- 21 Flusostat

**[TR] KOMBI FONKSIYONEL ELEMENLARI**

- 1 Doldurma musluğu
- 2 Tahliye musluğu
- 3 3-yollu vana
- 4 Emniyet valfi
- 5 Şebeke sıcak su NTC ölçüm ucu
- 6 Şirkülasyon pompası
- 7 Hava deliği vanası
- 8 Brülör
- 9 Alev tutuşma- saptama elektrodu
- 10 Limit termostat
- 11 Temel NTC ölçüm ucu
- 12 Fan
- 13 Tazyik ölçüm borusu
- 14 Baca gazı flanşı
- 15 Diferansiyel baca gazı basınç anahtarı
- 16 Genleşme tankı
- 17 Isı eşanjörü
- 18 Isıtma basınç anahtarı
- 19 Gaz vanası
- 20 Şebeke sıcak su eşanjörü
- 21 Akış anahtarı

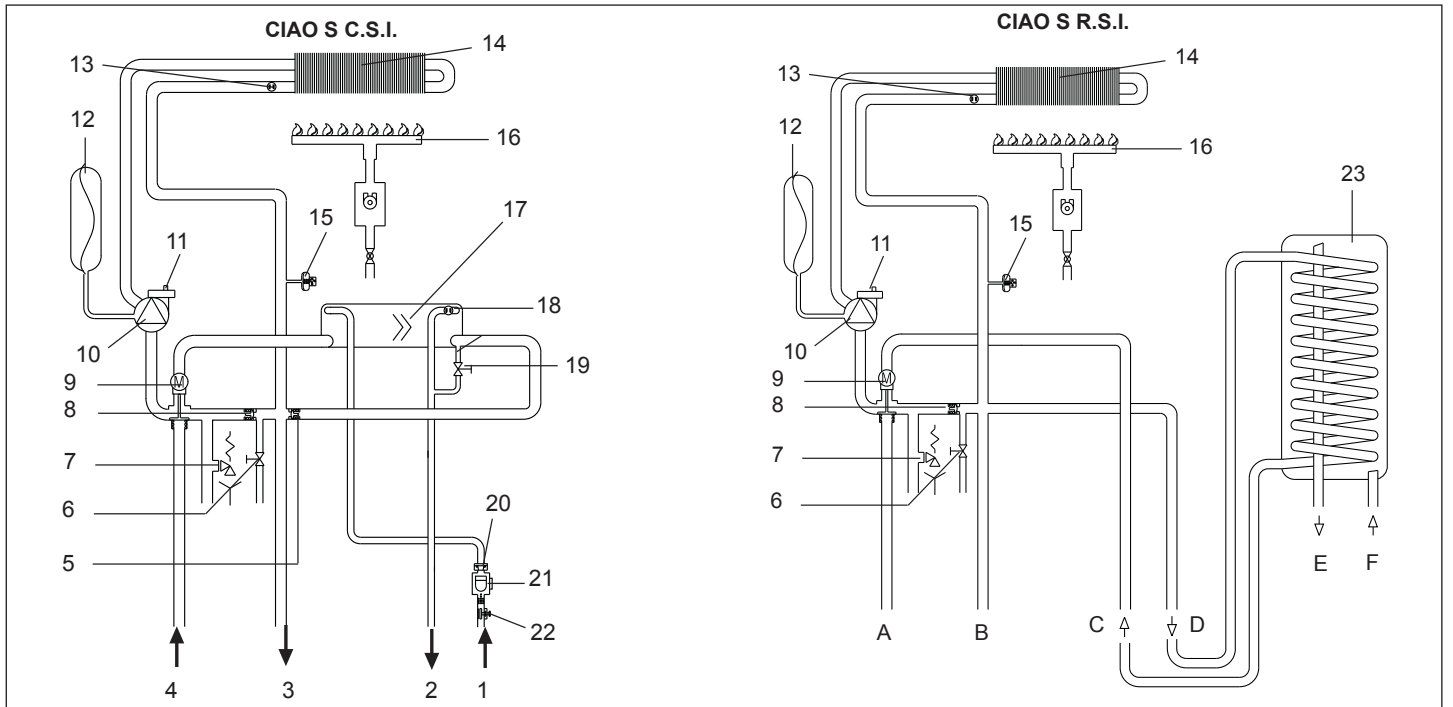

#### [EN] HYDRAULIC CIRCUIT

- A Heating return  
 B Heating delivery  
 C Water tank return  
 D Water tank delivery  
 E Hot water outlet  
 F Cold water inlet  
 1 DHW input  
 2 DHW output  
 3 Heating delivery  
 4 Heating return line  
 5 Non return valve  
 6 Drain tap  
 7 Safety valve  
 8 By-pass  
 9 3-way valve  
 10 Circulator with bleed  
 11 Air vent valve  
 12 Expansion tank  
 13 Primary NTC probe  
 14 Heat exchanger  
 15 Water pressure switch  
 16 Burner  
 17 Domestic hot water exchanger  
 18 Domestic hot water NTC probe  
 19 Filling tap  
 20 Delivery limiter  
 21 Flow switch  
 22 Filter  
 23 Water tank (available on request)

#### [F] CIRCUIT HYDRAULIQUE

- A Retour du chauffage  
 B Refoulement du chauffage  
 C Retour du réservoir d'eau  
 D Refoulement du réservoir d'eau  
 E Sortie d'eau chaude  
 F Entrée d'eau froide  
 1 Entrée sanitaire  
 2 Sortie sanitaire  
 3 Refoulement chauffage  
 4 Retour chauffage  
 5 Soupape de non-retour  
 6 Robinet de vidange  
 7 Soupape de sécurité  
 8 By-pass  
 9 Vanne à 3 voies  
 10 Circulateur avec purge  
 11 Purgeur d'air  
 12 Vase d'expansion  
 13 Sonde NTC primaire  
 14 Échangeur  
 15 Pressostat d'eau  
 16 Brûleur  
 17 Échangeur sanitaire  
 18 Sonde NTC sanitaire  
 19 Robinet de remplissage  
 20 Limiteur de débit  
 21 Fluxostat  
 22 Filtre  
 23 Réservoir d'eau (disponible sur demande)

#### [ES] CIRCUITO HIDRÁULICO

- A Retorno calefacción  
 B Alimentación calefacción  
 C Retorno interacumulador  
 D Alimentación interacumulador  
 E Salida agua caliente  
 F Entrada agua fría  
 1 Entrada agua sanitaria  
 2 Salida agua sanitaria  
 3 Ida calefacción  
 4 Retorno calefacción  
 5 Válvula de retención  
 6 Grifo de vaciado  
 7 Válvula de seguridad  
 8 By-pass  
 9 Vanne à 3 voies  
 10 Circulador con purgado  
 11 Válvula de purgado de aire  
 12 Vaso de expansión  
 13 Sonda NTC primario  
 14 Intercambiador  
 15 Presostato agua  
 16 Quemador  
 17 Intercambiador sanitario  
 18 Sonda NTC agua sanitaria  
 19 Grifo de llenado  
 20 Limitador de caudal  
 21 Flusostato  
 22 Filtro  
 23 Interacumulador (opcional)

#### [PT] CIRCUITO HIDRÁULICO

- A Retorno do aquecimento  
 B Descarga do aquecimento  
 C Retorno do boiler  
 D Descarga do boiler  
 E Saída da água quente  
 F Entrada da água fria  
 1 Entrada sanitário  
 2 Saída sanitário  
 3 Envio aquecimento  
 4 Retorno aquecimento  
 5 Válvula de não retorno  
 6 Válvula de descarga  
 7 Válvula de segurança  
 8 By-pass  
 9 Válvula de 3 vias  
 10 Circulador com respiro  
 11 Válvula de desgasificação  
 12 Vaso de expansão  
 13 Sonda NTC primário  
 14 Permutador  
 15 Pressostato da água  
 16 Queimador  
 17 Intercambiador sanitario  
 18 Sonda NTC sanitário  
 19 Válvula de enchimento  
 20 Limitador de vazão  
 21 Fluxostato  
 22 Filtro  
 23 Boiler (que pode ser fornecido a pedido)

#### [SRB] HIDRAULIČKI KRUG

- A Povrat grejanja  
 B Potis grejanja  
 C Povrat bojlera  
 D Izlaz iz bojlera  
 E Izlaz tople vode  
 F Ulaz hladne vode  
 1 Sanitarni ulaz  
 2 Sanitarni izlaz  
 3 Potisni vod  
 4 Povratni vod  
 5 Nepovratni ventil  
 6 Slavina za pražnjenje  
 7 Sigurnosni ventil  
 8 By-pass  
 9 Ventil 3 sistemski  
 10 Cirkulaciona pumpa  
 11 Ventil za ispuš vazduha  
 12 Ekspanziona posuda  
 13 Primarna NTC sonda  
 14 Izmenjivač  
 15 Merač pritiska vode  
 16 Gorionik  
 17 Izmenjivač sanitarne vode  
 18 Sanitarna NTC sonda  
 19 Slavina za punjenje  
 20 Graničnik protoka  
 21 Flusostat  
 22 Filtre  
 23 Bojler (isporučuje se na zahtev)

#### [TR] HİDROLİK DEVRE

- A Isıtma dönüşü  
 B Isıtma tevzi  
 C Su tankı dönüşü  
 D Su tankı tevzi  
 E Sıcak su çıkışı  
 F Soğuk su girişi  
 1 DHW giriş  
 2 DHW çıkış  
 3 Isıtma tevzi  
 4 Isıtma dönüş hattı  
 5 Tek yönlü vana  
 6 Tahliye musluğu  
 7 Emniyet valfi  
 8 By-pass  
 9 3-yollu vana  
 10 Sirkülatör  
 11 Hava deliği vanası  
 12 Genleşme tankı  
 13 Temel NTC ölçüm ucu  
 14 Isı eşanjörü  
 15 Su basıncı anahtarı  
 16 Brülör  
 17 Şebeke sıcak su eşanjörü  
 18 Şebeke sıcak su NTC ölçüm ucu  
 19 Doldurma musluğu  
 20 Tahliye sınırlandırıcı  
 21 Akış anahtarı  
 22 Filtre  
 23 Su tankı (talep halinde mevcut)



Ciao S 24 R.S.I.					
IP				European Directive 92/42/ EEC: $\eta =$	
N. 0000000000					
230 V ~ 50 Hz W		Qn =			
		Pn =		NOx:	
Pms = T= °C		set at: calibrado: engestellt auf: réglage:			
****		dostosowane do:			

Ciao S 20 C.S.I.					
IP				European Directive 92/42/ EEC: $\eta =$	
N. 0000000000					
230 V ~ 50 Hz W		Qn =		D: l/min	
Pmw = bar T= °C		Pn =		NOx:	
Pms = bar T= °C		B22P-B52P-C12-C22-C32-C42-C52-C62-C82-C92-C12x-C32x-C42x-C52x-C62x-C82x-C92x		set at: calibrado: engestellt auf: réglage:	
****		dostosowane do:			

[EN] SERIAL NUMBER PLATE

- Domestic hot water operation
- Heating function
- Qn** Nominal capacity
- Pn** Nominal power
- IP** Protection level
- Pmw** Domestic hot water maximum pressure
- Pms** Heating maximum pressure
- T** Temperature
- $\eta$  Working efficiency
- D** Specific capacity
- NOx** NOx Value class

[F] PLAQUE D'IMMATRICULATION

- Fonction sanitaire
- Fonction chauffage
- Qn** Débit thermique
- Pn** Puissance thermique
- IP** Degré de protection
- Pmw** Pression d'exercice maximum sanitaire
- Pms** Pression maximum chauffage
- T** Température
- $\eta$  Rendement
- D** Débit spécifique
- NOx** Classe NOx

[ES] TARJETA DE LA MATRÍCULA

- Función sanitaria
- Función calefacción
- Qn** Potencia máxima nominal
- Pn** Potencia máxima útil
- IP** Grado de protección
- Pmw** Presión máxima agua sanitaria
- Pms** Presión máxima calefacción
- T** Temperatura
- $\eta$  Rendimiento
- D** Caudal específico
- NOx** Clase NOx

[PT] ETIQUETA MATRÍCULA

- Função sanitária
- Função aquecimento
- Qn** Capacidade térmica
- Pn** Potência térmica
- IP** Grau de protecção
- Pmw** Máxima pressão de exercício sanitário
- Pms** Máxima pressão de aquecimento
- T** Temperatura
- $\eta$  Rendimento
- D** Vazão específica
- NOx** Classe NOx

[SRB] OSNOVNE OZNAKE

- Funkcije sanitarija
- Funkcije zagrevanja
- Qn** Termički raspon
- Pn** Termička snaga
- IP** Nivo zaštite
- Pmw** Maksimalni pritisak sanitarnog rada
- Pms** Maksimalni pritisak zagrevanja
- T** Temperatura
- $\eta$  Kapacitet
- D** Specifični raspon
- NOx** Klasa NOx

[TR] SERİ NUMARASI PLAKASI

- Şebeke sıcak su işlemi
- Isıtma fonksiyonu
- Qn** Nominal kapasite
- Pn** Nominal güç
- IP** Koruma seviyesi
- Pmw** Şebeke sıcak su maksimum basınç
- Pms** Isıtma maksimum basınç
- T** Sıcaklık
- $\eta$  Çalışma verimliliği
- D** Spesifik kapasite
- NOx** NOx Değer sınıfı

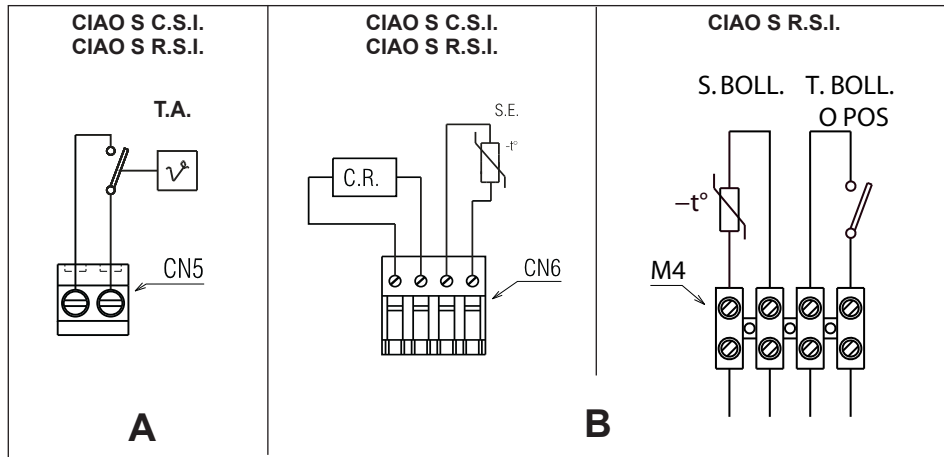

#### [EN] AMBIENT THERMOSTAT CONNECTION

**T.A.** Ambient thermostat

**A** The ambient thermostat (24Vdc) should be connected as indicated in the diagram once the U-bolt on the 2-way connector (CN5) has been removed.

#### **Warning**

TA input in safety low voltage.

**B** Low voltage devices should be connected to connector CN6-M4, as shown in the figure.

C.R. Remote control

SE External probe

TBOLL Boiler thermostat or domestic water time programmer (POS)

SBOLL Storage tank

#### [F] BRANCHEMENT DU THERMOSTAT D'AMBIANCE

**T.A.** Thermostat d'ambiance

**A** Le thermostat d'ambiance (24Vdc) sera inséré, comme indiqué dans le schéma, après avoir enlevé le cavalier présent sur le connecteur à 2 voies (CN5).

#### **Attention**

Entrée TA à basse tension de sécurité.

**B** Les dispositifs de basse tension seront branchés sur le connecteur CN6-M4, comme indiqué sur la figure.

C.R. commande à distance

SE sonde externe

TBOLL Thermostat chaudière ou programmeur horaire d'eau sanitaire (POS)

SBOLL Sonde du chauffe-eau

#### [ES] CONEXIÓN DEL THERMOSTATO AMBIENTE

**T.A.** Termostato ambiente

**A** El termostato ambiente (24Vdc) se instalará como se indica en el esquema después de quitar el puente del conector de 2 vías (CN5).

#### **Atención**

Entrada TA con baja tensión de seguridad.

**B** Los dispositivos de baja tensión se conectarán en el conector CN6-M4, como indica la figura.

C.R. mando a distancia

SE sonda exterior

TBOLL Termostato de caldera o programador de tiempo de agua sanitaria (POS)

SBOLL Sonda interacumulador

#### [PT] CONEXÃO TERMÓSTATO AMBIENTE

**T.A.** Termóstato ambiente

**A** Il termóstato ambiente (24Vdc) será activado como indicado pelo esquema depois de ter tirado a forquilha presente no conector 2 vias (CN5).

#### **Atenção**

Entrada TA em baixa tensão de segurança.

**B** As utilizações de baixa tensão serão ligadas como indicado na figura no conector CN6-M4.

C.R. comando remoto

SE sonda externa

TBOLL Termóstato de caldeira ou programador de tempo de água sanitária (POS)

SBOLL Sonda do boiler

#### [SRB] MESTO SPAJANJA TERMOSTATA

**T.A.** Sobni termostat

**A** Sobni termostat (24Vdc) postavite kao što je označeno na shemi nakon što ste skinuli okvir sa priključka 2 pravca (CN5).

#### **Upozorenje**

Ulaz TA je niskog sigurnosnog napona.

**B** Delove niske voltaže ćete povezati kao što je označeno na slici na priključku CN6-M4.

C.R. daljinski upravljač

SE spoljna sonda

TBOLL Termostat kotla ili programator vremena sanitarne vode (POS)

SBOLL Sonda bojlera

#### [TR] ORTAM TERMOSTATI BAĞLANTISI

**T.A.** Ortam termostati

**A** Ortam termostati (24 Vdc) 2 yollu konektör (CN5) de U civatası söküldüğünde diyagramda gösterildiği gibi bağlanmalıdır.

#### **Uyarı**

Güvenli alçak gerilimde TA girişi.

**B** Alçak gerilim cihazları şekilde gösterildiği gibi CN6-M4 konektörüne bağlanmalıdır.

C.R. Uzaktan kumanda

SE Harici ölçüm ucu

TBOLL Kombi termostati veya şebeke saat programlayıcısı (POS)

SBOLL Depolama tankı

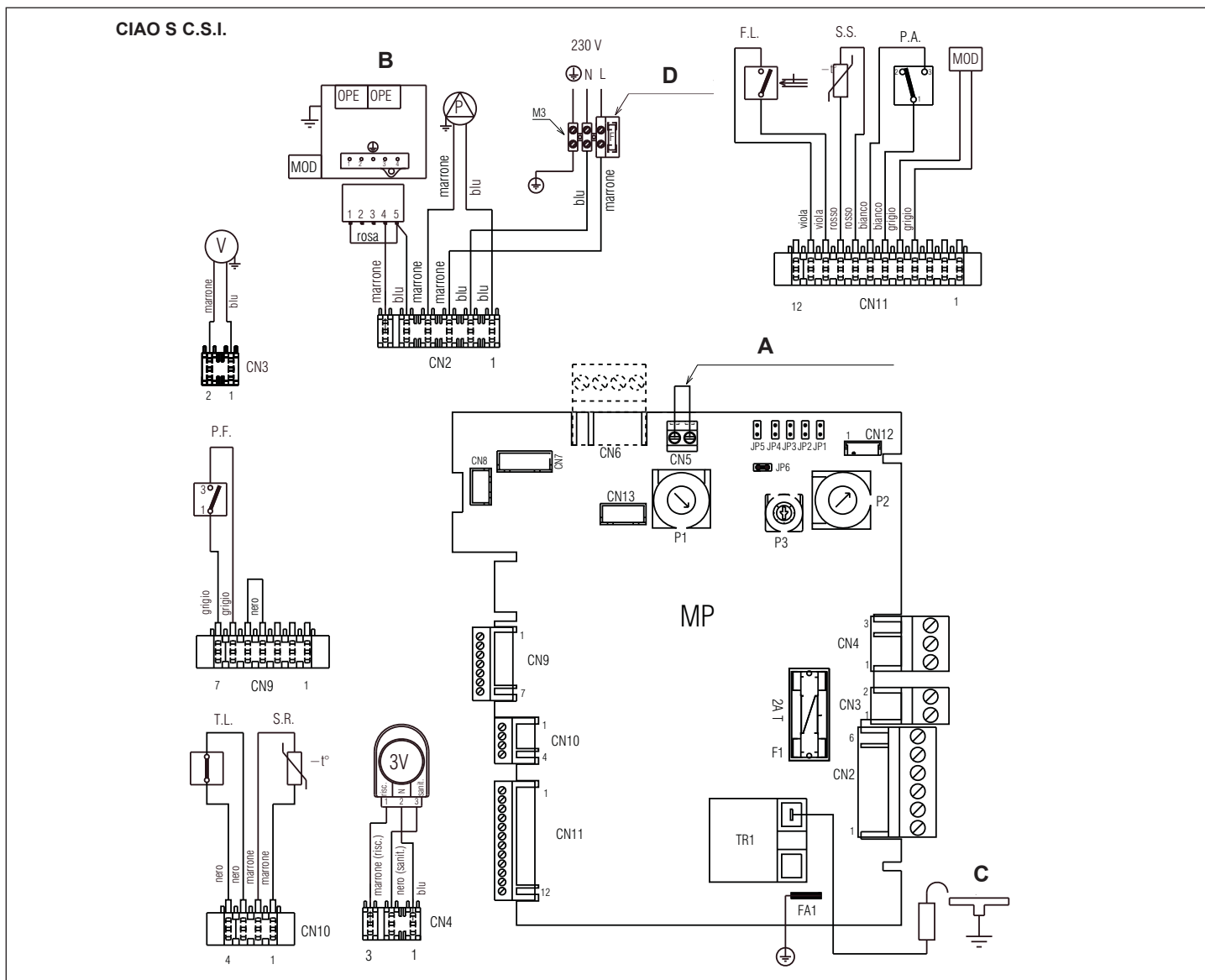

**[EN] "L-N" Polarisation is recommended**  
 Blu=Blue / Marrone=Brown / Nero=Black / Rosso=Red / Bianco=White / Viola=Violet / Grigio=Grey /  
 A = 24V Low voltage ambient thermostat jumper  
 B = Gas valve  
 C = I/D electrode  
 D = Fuse 3.15A F  
 MP Control card with digital display and integrated ignition transformer  
 P1 Potentiometer to select off - summer - winter – reset / temperature heating  
 P2 Potentiometer to select domestic hot water set point  
 P3 Potentiometer to select temperature regulation curve  
 JP1 Bridge to enable knobs for calibration  
 JP2 Bridge to reset the heating timer and log maximum electrical heating in calibration  
 JP3 Bridge to select MTN - LPG  
 JP4 Absolute domestic hot water thermostat selector  
 JP5 Bridge to select heating operation only (not used)  
 JP6 Flow switch management enabling (not used)  
 CN1+CN13 Connectors  
 F1 Fuse 2A T  
 F External fuse 3.15A F  
 M3 Terminal board for external connections  
 T.A. Ambient thermostat  
 E.A./R. Ignition/Detection electrode  
 TR1 Remote ignition transformer  
 V Fan  
 P.F. Flue gas pressure switch  
 S.R. Primary circuit temperature probe (NTC)  
 T.L. Limit thermostat  
 OPE Gas valve operator  
 P Pump  
 3V 3-way servomotor valve  
 F.L. Domestic hot water flow switch  
 S.S. Domestic hot water circuit temperature probe (NTC)  
 PA Heating pressure switch (water)  
 MOD Modulator

**[F] Il est conseillé d'utiliser la polarisation « L-N ».**  
 Bleu=Blue / Marron=Brown / Noir=Black / Rouge=Red / Blanc=White / Violet=Violet / Gris=Grey /  
 A = Jumper du thermostat dans un environnement de 24V  
 B = Soupape gaz  
 C = Électrode A/R  
 D = Fusible 3.15A F  
 MP Carte de commande avec écran numérique et transformateur d'allumage intégré  
 P1 Potentiomètre de sélection off - été - hiver – réarmement/température chauffage  
 P2 Potentiomètre de sélection point de consigne sélection point de consigne sanitaire  
 P3 Potentiomètre de sélection courbes de régulation thermique  
 JP1 Shunt activation poignées au réglage  
 JP2 Shunt mise à zéro minuterie chauffage et mémorisation du chauffage électrique maximum en réglage  
 JP3 Shunt sélection MTN - GPL  
 JP4 Sélecteur des thermostats absolus sanitaire  
 JP5 Shunt sélection fonctionnement uniquement chauffage (non utilisé)  
 JP6 Activation de la gestion du fluxmostat (non utilisé)  
 CN1+CN13 Connecteurs de branchement  
 F1 Fusible 2A T  
 F Fusible externe 3.15A F  
 M3 Bornier pour branchements externes  
 T.A. Thermostat d'ambiance  
 E.A./R. Électrode d'allumage/détection  
 TR1 Transformateur d'allumage à distance  
 V Ventilateur  
 P.F. Pressostat de fumées  
 S.R. Sonde (NTC) de température du circuit primaire  
 T.L. Thermostat limite  
 OPE Opérateur soupape gaz  
 P Pompe  
 3V Servomoteur de la vanne a 3 voies  
 F.L. Fluxostat sanitaire  
 S.S. Sonde (NTC) de température du circuit sanitaire  
 PA Pressostat chauffage (eau)  
 MOD Modulateur

**[ES] Se aconseja la polarización "L-N"**  
 Blu=Blue / Marrón=Brown / Negro=Black / Rojo=Red / Blanco=White / Violeta=Violet / Gris=Grey /  
 A = Puente termostato ambiente de baja tensión 24V  
 B = Válvula gas  
 C = Electrodo A/R  
 D = Fusible 3.15A F  
 MP Tarjeta de control con pantalla digital y transformador de encendido integrado  
 P1 Potenciometro selección off - verano - invierno – reset / temperatura calefacción  
 P2 Potenciometro selección set point agua sanitaria  
 P3 Potenciometro selección curvas termostatación  
 JP1 Puente habilitación pomos para la regulación  
 JP2 Puente reset timer calefacción y memorización de la máxima calefacción eléctrica regulada  
 JP3 Puente selección MTN - GLP  
 JP4 Selector termostatos agua sanitaria absolutos  
 JP5 Puente selección funcionamiento sólo calefacción (no utilizado)  
 JP6 Habilitación control flusostato (no utilizado)  
 CN1+CN13 Conectores de conexión  
 F1 Fusible 2A T  
 F Fusible exterior 3.15A F  
 M3 Bornera para conexiones externas  
 T.A. Termostato ambiente  
 E.A./R. Electrodo encendido/detección  
 TR1 Transformador de encendido a distancia  
 V Ventilador  
 P.F. Presostato humos  
 S.R. Sonda (NTC) temperatura circuito primario  
 T.L. Termostato límite  
 OPE Operador válvula gas  
 P Bomba  
 3V Servomotor válvula de 3 vías  
 F.L. Fluxostat sanitario  
 S.S. Sonda (NTC) temperatura circuito sanitario  
 PA Presostato calefacción (agua)  
 MOD Modulator

**[PT] A polarização "L-N" é recomendada**

Blu=Blue / Marrom=Brown / Preto=Black / Vermelho=Red/ Branco=White / Violeta=Violet / Cinza=Grey /  
A = Conexão termóstato ambiente baixa tensão 24V  
B = Válvula do gás  
C = Eléctrodo A/R  
D = Fusível 3.15A F  
MP Cartão de controlo com mostrador digital e transformador de ignição integrado  
P1 Potenciómetro selecção off - verão - inverno – reset / temperatura aquecimento  
P2 Potenciómetro selecção set point sanitário  
P3 Potenciómetro selecção curvas termo-regulação  
JP1 Ponte habilitação manipulo para a calibragem  
JP2 Ponte zeramento timer aquecimento e memorização máximo eléctrico aquecimento em calibragem  
JP3 Ponte selecção MTN - GPL  
JP4 Selector termóstatos sanitário absolutos  
JP5 Ponte selecção e funcionamento somente aquecimento (não utilizado)  
JP6 Habilitação gestão fluxostato (não utilizado)  
CN1÷CN13 Conectores de conexão  
F1 Fusível 2A T  
F Fusível externo 3.15A F  
M3 Rêgua de terminais para conexões externas  
T.A. Termóstato ambiente  
E.A./R. Eléctrodo acendimento / observação  
TR1 transformador de acendimento remoto  
V Ventilador  
P.F. Pressostato fumos  
S.R. Sonda (NTC) temperatura circuito primário  
T.L. Termóstato limite  
OPE Operador válvula gás  
P Bomba  
3V Servomotor válvula 3 vias  
F.L. Fluxostato sanitário  
S.S. Sonda (NTC) temperatura circuito sanitário  
PA Pressostato aquecimento (água)  
MOD Modulador

**[SRB] Polarizacija "L-N" se savetuje**

Plava=Blue / Smeđa=Brown / Crna=Black / Crvena=Red / Bela=White / Ljubičasta=Violet / Siva=Grey /  
B = Ventil za gas  
A = Jumper termostat niskog napona 24V  
C = Elektroda A/R  
D = Osigurač 3.15A F  
MP Kontrolna kartica sa digitalnim displejom i integrisanim transformatorom paljenja  
P1 Potencijometar izaberite off - leto - zima – reset / temperatura grejanje  
P2 Potencijometar za izbor sanitarnog set point-a  
P3 Potencijometar za izbor krive termoregulacije  
JP1 Most za osposobljavanje komandi za tariranje  
JP2 Most za poništavanje timer-a grejanja i memorisanje električnog maksimuma grejanja  
JP3 Most za izbor MTN - GPL  
JP4 Birač termostata sanitarne vode  
JP5 Most za izbor funkcije samo grejanje (nije upotreblijevan)  
JP6 Ograničenje postupka flusostat (nije upotreblijevan)  
CN1÷CN13 Priključci za povezivanje  
F1 Osigurač 2A T  
F Spoljni osigurač 3.15A F  
M3 Deo za spoljna povezivanja  
T.A. Sobni termostat  
E.A./R. Elektroda za paljenje / podizanje  
TR1 Transformator za paljenje  
V Ventilator  
P.F. Merač pritiska gasova  
S.R. Sonda (NTC) temperature primarnog kruga  
T.L. Granični termostat  
OPE Operator ventila za gas  
P Pumpa  
3V Servo ventil 3 sistemski  
F.L. Flusostat  
S.S. Sonda (NTC) temperature sanitarnog kruga  
PA Vodeni presostat  
MOD Modulator

**[[TR] "L-N" Polarizasyonu önerilir**

Blu=Mavi / Marrone=Kahve / Nero=Siyah / Rosso=Kırmızı/ Bianco=Beyaz / Viola=Lila / Grigio=Gri /  
A = 24V Alçak gerilim ortam termostati bağlantı kablosu  
B = Gaz vanası  
C = I/D elektrod  
D = Sigorta 3.15A F  
MP Dijital göstergeli ve entegre açma transformatörlü kumanda levhası  
P1 Yaz - kış - reset / sıcaklık ısıtma seçmek için potansiyometre  
P2 Şebeke sıcak su ayar noktası seçmek için potansiyometre  
P3 Sıcaklık düzenleme eğrisi seçmek için potansiyometre  
JP1 Düğmeleri kalibrasyona etkin hale getirmek için köprü  
JP2 Kalibrasyonda maksimum elektrik ısıtma ve ısıtma zamanlayıcısını resetlemek için köprü  
JP3 MTN - LPG seçmek için köprü  
JP4 Mutlak şebeke sıcak su termostat seçicisi  
JP5 Sadece ısıtma işlemini seçmek için köprü (kullanılmıyor)  
JP6 Etkin akış anahtarı yönetimi (kullanılmıyor)  
CN1÷CN13 konektör  
F1 Sigorta 2A T  
F Harici sigorta 3.15A F  
M3 Harici bağlantı için terminal levha  
T.A. Ortam termostati  
E.A./R. Ateşleme/Saptama elektrodu  
TR1 Uzaktan ateşleme transformatörü  
V Fan  
P.F. Baca gazı basınç anahtarı  
S.R. Temel devre sıcaklık ölçüm ucu (NTC)  
T.L. Limit termostati  
OPE Gaz vana operatörü  
P Pompa  
3 3-yollu servomotor vana  
F.L. Şebeke sıcak su akış anahtarı  
S.S. Şebeke sıcak su devre sıcaklığı ölçüm ucu (NTC)  
PA Isıtma basınç anahtarı (su)  
MOD Modülator

CIAO S R.S.I.

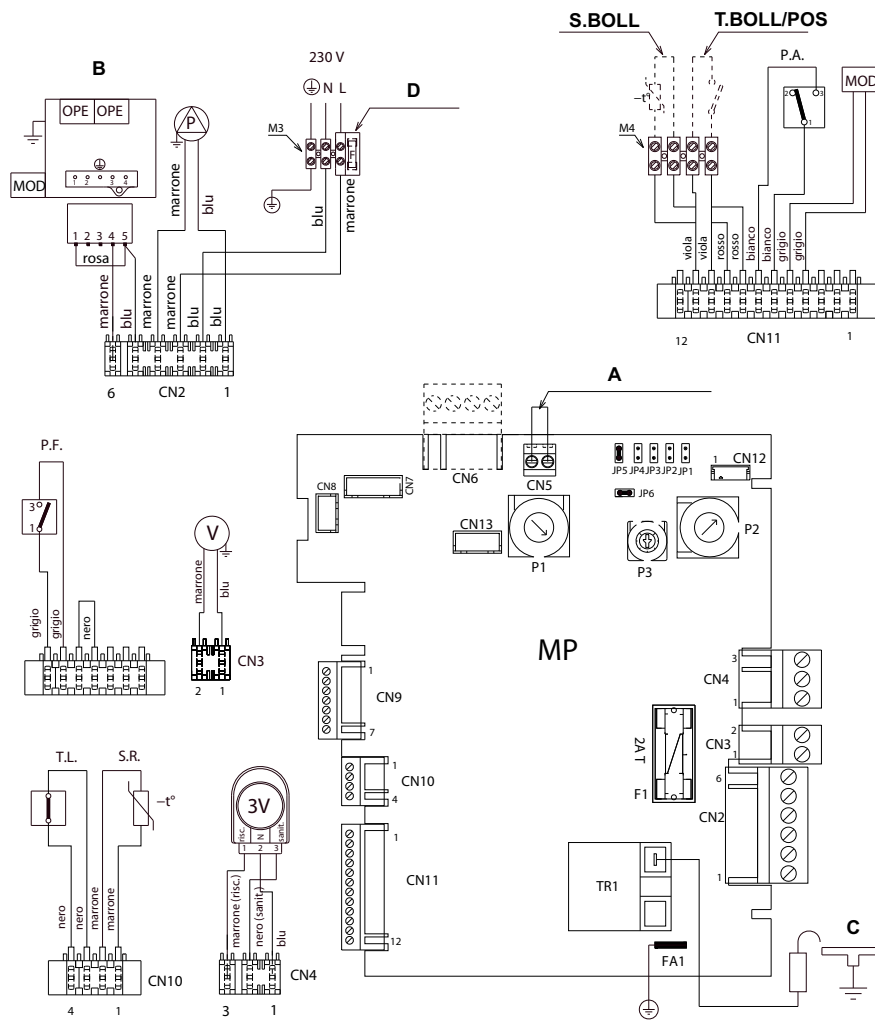

**[EN] "L-N" - "L-N" Polarisation is recommended**  
 Blu=Blue / Marrone=Brown / Nero=Black / Rosso=Red/ Bianco=White / Viola=Violet / Grigio=Grey / Arancione=Orange

A = 24V Low voltage ambient thermostat jumper  
 B = Gas valve  
 C = I/D electrode  
 D = Fuse 3.15A F  
 MP Control card with digital display and integrated ignition transformer  
 P1 Potentiometer to select off - summer - winter - reset / temperature heating  
 P2 Potentiometer to select domestic hot water set point  
 P3 Potentiometer to select temperature regulation curve  
 JP1 Bridge to enable knobs for calibration  
 JP2 Bridge to reset the heating timer and log maximum electrical heating in calibration  
 JP3 Bridge to select MTN - LPG  
 JP4 Absolute domestic hot water thermostat selector  
 JP5 Bridge heating only function selection with provision for external boiler with thermostat or probe  
 JP6 not used  
 F1 Fuse 2A T  
 F External fuse 3.15A F  
 M3 Terminal board for external connections: 230V  
 M4 Morsettiera per collegamenti esterni: sonda bollitore/termostato bollitore o programmatore orario sanitario (POS)

T.A. Ambient thermostat  
 E.A./R. Ignition/Detection electrode  
 TR1 Remote ignition transformer  
 V Fan  
 P.F. Flue gas pressure switch  
 S.R. Primary circuit temperature probe (NTC)  
 T.L. Limit thermostat  
 OPE Gas valve operator  
 P Pump  
 3V 3-way servomotor valve  
 T.BOLL Water tank thermostat  
 POS Domestic water time programmer  
 S.BOLL. Storage tank  
 PA Heating pressure switch (water)  
 MOD Modulator  
 CN1+CN13 Connectors

**[F] « L-N » - La polarisation « L-N » est recommandée**  
 Blu=Bleu / Marrone=Marron / Nero=Noir / Rosso=Rouge / Bianco=Blanc / Viola=Violet / Grigio=Gris / Arancione=Orange

A = Cavalier de thermostat d'ambiance à basse tension 24V  
 B = Robinet du gaz  
 C = Électrode I/D  
 D = Fusible 3.15A F  
 MP Carte de commande avec écran numérique et transformateur d'allumage intégré  
 P1 Potentiomètre de sélection off - été - hiver - température de réarmement/ chauffage  
 P2 Potentiomètre de sélection du point de consigne d'eau chaude sanitaire  
 P3 Potentiomètre de sélection de courbe de réglage de la température  
 JP1 Cavalier permettant le réglage de la poignée  
 JP2 Cavalier de réarmement de la minuterie de chauffage et de réglage maximum du chauffage électrique  
 JP3 Cavalier de sélection MTN - GPL  
 JP4 Sélecteur absolu du thermostat d'eau chaude sanitaire  
 JP5 Cavalier de sélection de fonction chauffage uniquement avec disposition pour chaudière extérieure à thermostat ou sonde  
 JP6 non utilisé  
 F1 Fusible 2A T  
 F Fusible extérieur 3.15A F  
 M3 Bornier pour branchements extérieurs : 230V  
 M4 Bornier pour branchements extérieurs : sonde chaudière/thermostat chaudière ou programmatore horaire sanitaire (POS)

T.A. Thermostat d'ambiance  
 E.A./R. Électrode d'allumage/détection  
 TR1 Transformateur d'allumage à distance  
 V Ventilateur  
 P.F. Pressostat de fumées  
 S.R. Sonde de température du circuit primaire (NTC)  
 T.L. Thermostat limite  
 OPE Opérateur du robinet du gaz  
 P Pompe  
 3V Vanne 3 voies du servomoteur  
 T.BOLL Thermostat du réservoir d'eau  
 POS programmatore horaire d'eau sanitaire  
 S.BOLL. Réservoir d'accumulation  
 PA Pressostat de chauffage (eau)  
 MOD Modulateur  
 CN1+CN13 Connecteurs

**[ES] "L-N" - Se recomienda la polarización "L-N"**  
 Blu=Azul / Marrone=Marrón / Nero=Negro / Rosso=Rojo/ Bianco=Blanco / Viola=Violeta / Grigio=Gris /

A = 24V Jumper de termostato ambiental de baja tensión  
 B = Válvula gas  
 C = I/D electrodo  
 D = Fusible 3.15A F  
 MP Tarjeta de control con pantalla digital y transformador de encendido integrado  
 P1 Potenciometro para seleccionar apagado - verano - invierno - desbloqueo / calentamiento de temperatura  
 P2 Potenciometro para seleccionar set point de agua caliente sanitaria  
 P3 Potenciometro para seleccionar curva de regulación de temperatura  
 JP1 Puente para habilitar los pomos de regulación  
 JP2 Puente para restablecer el temporizador de calefacción y regular la calefacción eléctrica máxima  
 JP3 Puente para seleccionar MTN - GPL  
 JP4 Selector de termostato absoluto para agua caliente sanitaria  
 JP5 Sólo función de selección del puente de calefacción con provisión para caldera externa con termostato o sonda  
 JP6 sin uso  
 F1 Fusible 2A T  
 F Fusible externo 3.15A F  
 M3 Regleta de conexión para conexiones externas 230V  
 M4 Caja de terminales para conexiones externas: sonda calentador/termostato calentador o programador horario sanitario (POS)

T.A. Termostato ambiental  
 E.A./R. Encendido/Electrodo de detección  
 TR1 Transformador de encendido remoto  
 V Ventilador  
 P.F. Chimenea de presostato gas  
 S.R. - Sonda de temperatura del circuito primario (NTC)  
 T.L. Termostato límite  
 OPE - Operador válvula del gas  
 P Bomba  
 3V Servomotor de válvula de tres vías  
 T.BOLL Termostato de depósito de agua  
 POS programador de tiempo de agua sanitaria  
 S.BOLL. Depósito de acumulación  
 PA Presostato de calefacción (agua)  
 MOD Modulator  
 CN1+CN13 Conectores

**[PT] "L-N" - A polarização "L-N" é recomendada**  
Blu=Azul escuro / Marrone=Marron / Nero=Preto / Rosso=Vermelho/ Bianco=Branco / Viola=Violeta / Grigio=Cinza / Arancione=Laranja  
A = Jumper do termóstato ambiente de baixa tensão 24 V  
B = Válvula de gás  
C = Eléctrodo I/D  
D = Fusível 3,15 A F  
MP Placa de controlo  
P1 Potenciómetro para seleccionar - verão - inverno – desbloqueio / aquecimento de temperatura  
P2 Potenciómetro para seleccionar o ponto de ajuste da água quente sanitária  
P3 Potenciómetro para seleccionar a curva de regulação de temperatura  
JP1 Ponte para habilitar os manipulados para calibragem  
JP2 Ponte para desbloquear o temporizador de aquecimento e registar o aquecimento eléctrico máximo na calibragem  
JP3 Ponte para seleccionar MTN - LPG  
JP4 Selector termóstato água quente sanitária absoluto  
JP5 Seleção de função de somente aquecimento da ponte com provisão para caldeira externa com termóstato ou sonda  
JP6 não utilizado  
F1 Fusível 2 A T  
F Fusível externo 3.15A F  
Régua de terminais M3 para conexões externas: 230 V  
M4 Régua de terminais para conexões externas: sonda da caldeira/termóstato da caldeira ou programador horário sanitário (POS)  
T.A. Termóstato ambiente  
E.A./R. Eléctrodo de acendimento/deteção  
TR1 Transformador de ignição remoto  
V Ventilador  
P.F. Pressostato de gás da chaminé  
S.R. Sonda de temperatura do circuito primário (NTC)  
T.L. Termóstato de limite  
OPE Operador da válvulas do gás  
P Bomba  
3 V Válvula do servomotor de 3 vias  
T.BOLL Termóstato do depósito de água  
POS programador de tempo de água sanitária  
S.BOLL. Reservatório de armazenamento  
PA Pressostato de aquecimento (água)  
Modulador MOD  
Conectores CN1÷CN13

**[SRB] "L-N" - "L-N" polarizacija se preporučuje**  
Blu=plava/ Marrone=braon / Nero=crna / Rosso=crvena/ Bianco=bela / Viola=ljubičasta / Grigio=siva / Arancione=narandžasta  
A = 24V džemper sobnog termostata niskog napona  
B = Ventil za gas  
C = I/D elektroda  
D = Osigurač od 3,15A F  
MP Kontrolna kartica sa digitalnim displejom i integrisanim transformatorom paljenja  
P1 Potenciometar za izbor off – leto – zima – reset / temperatura grejanja  
P2 Potenciometar za izbor zadate vrednosti sanitarne vode  
P3 Potenciometar za izbor krive regulacije temperature  
JP1 Premostite da biste osposobili dugmad za kalibraciju  
JP2 Premostite da biste resetovali tajmer grejanja i unesite maksimalnu temperaturu električnog grejanja u kalibraciju  
JP3 Premostite da biste izabrali MTN - GPL  
JP4 Birač za sanitarni i centralne termostate  
JP5 Premostite odabir funkcije samo grejanja sa obezbeđenjem termostata ili sonde za spoljni kotao  
JP6 nije korišćen  
F1 Osigurač 2A T  
F Eksterni osigurač 3,15A F  
M3 Redna stezaljka za spoljašnja povezivanja: 230V  
M4 Redna stezaljka za spoljašnja povezivanja: sonda bojlera/ Termostat kotla ili programator vremena sanitarne vode (POS)  
T.A. Sobni termostat  
E.A./R. Elektroda paljenja/detekcije  
TR1 Daljinski transformator paljenja  
V Ventilator  
P.F. Presostat dimnog gasa  
S.R. Sonda temperature na primarnom kolu (NTC)  
T.L. Granični termostat  
OPE Operator ventila za gas  
P Pumpa  
3V Servomotor 3-krakog ventila  
T.BOLL Termostat rezervoara za vodu  
S.BOLL. Rezervoar  
PA Servomotor trokrakog ventila)  
MOD Modulátor  
CN1÷CN13 Konektori

**[TR] "L-N" - "L-N" Polarizasyonu önerilir**  
Blu=Mavi / Marrone=Kahve / Nero=Siyah / Rosso=Kırmızı/ Bianco=Beyaz / Viola=Lila / Grigio=Gri / Arancione=Turuncu  
A = 24V Alçak gerilim ortam termostatı bağlantı kablosu  
B = Gaz vanası  
C = I/D elektrod  
D = Sigorta 3.15A F  
MP Dijital göstergeli ve entegre açma transformatorlü kumanda levhası  
P1 Yaz - kış - reset / sıcaklık ısıtma seçmek için potansiyometre  
P2 Şebeke sıcak su ayar noktası seçmek için potansiyometre  
P3 Sıcaklık düzenleme eğrisi seçmek için potansiyometre  
JP1 Düğmeleri kalibrasyona etkin hale getirmek için köprü  
JP2 Kalibrasyonda maksimum elektrik ısıtma ve ısıtma zamanlayıcısını resetlemek için köprü  
JP3 MTN - LPG seçmek için köprü  
JP4 Mutlak şebeke sıcak su termostat seçicisi  
JP5 Sadece termostatlı veya sondalı harici kazanlı ısıtma ile çalışma seçeneği için köprü  
JP6 kullanılmıyor  
F1 Sigorta 2A T  
F Harici sigorta 3.15A F  
M3 Harici bağlantı için terminal levha: 230V  
M4 Dış bağlantılar için pens düzeneği: kazan sondası-kazan termostat veya şebeke saat programlayıcısı (POS)  
T.A. Ortam termostati  
E.A./R. Ateşleme/Saptama elektrodu  
TR1 Uzaktan ateşleme transformatorü  
V Fan  
P.F. Baca gazı basınç anahtarı  
S.R. Temel devre sıcaklık ölçüm ucu (NTC)  
T.L. Limit termostati  
OPE Gaz vana operatörü  
P Pompa  
3V 3-yollu servomotor vana  
T.BOLL Su tankı termostat  
S.BOLL. Depolama tankı  
PA Isıtma basınç anahtarı (su)  
MOD Modulátor  
CN1÷CN13 konektör

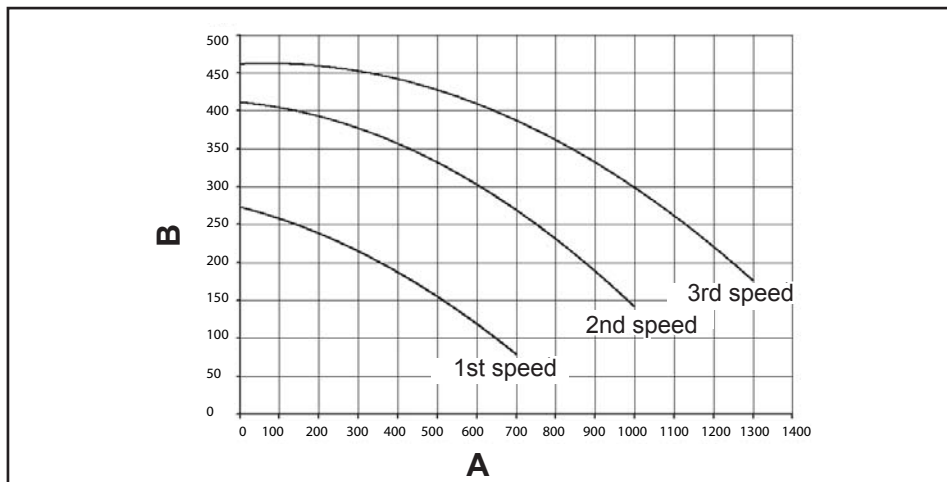
**[F] Prévalence résiduelle du circulateur****A= Débit (l/h)****B= Prévalence (mbar)**

La prévalence résiduelle pour l'installation de chauffage est représentée en fonction du débit dans le graphique ci-contre.

Le dimensionnement des tuyaux de l'installation de chauffage doit être effectué en considérant la valeur de la prévalence résiduelle disponible.

Il faut prendre en compte que la chaudière fonctionne correctement s'il y a une circulation d'eau suffisante dans l'échangeur de l'installation de chauffage.

Dans ce but, la chaudière est équipée d'un by-pass automatique qui règle un débit d'eau correct dans l'échangeur de chauffage, dans n'importe quelle condition de l'installation.

First speed = première vitesse

Second speed = deuxième vitesse

Third speed = troisième vitesse

**[ES] Altura de carga residual del circulador****A= Caudal (l/h)****B= Altura de carga (mbar)**

La altura de carga residual para la instalación de calefacción está representada, en función del caudal, por el gráfico de al lado.

El tamaño de las tuberías de la instalación de calefacción debe calcularse considerando el valor de la altura de carga residual disponible.

Se debe tener presente que la caldera funciona correctamente si el intercambiador de la calefacción tiene suficiente circulación de agua.

Por ello, la caldera está equipada con un by-pass automático que regula el caudal correcto de agua en el intercambiador de calefacción en cualquier condición de la instalación.

First speed = primera velocidad

Second speed = segunda velocidad

Third speed = tercera velocidad

**[EN] Circulator residual head****A= Capacity (l/h)****B= Head (mbar)**

The residual head for the heating system is represented, according to capacity, in the next graph. Heating system piping dimensioning must be carried out bearing in mind the value of the available residual head.

Bear in mind that the boiler operates correctly if water circulation in the heat exchanger is sufficient. To this aim, the boiler is equipped with an automatic by-pass that adjusts water capacity properly in the heat exchanger in any system conditions.

First speed

Second speed

Third speed

**[PT] Prevalência residual do circulador****A= Vazão (l/h)****B= Prevalência (mbar)**

A prevalência residual para a instalação de aquecimento é representada, em função da vazão, pelo gráfico ao lado.

O dimensionamento das tubagens da instalação de aquecimento deve ser executado considerando o valor da prevalência residual disponível.

Considere-se que a caldeira funciona correctamente se no permutador do aquecimento existe uma circulação de água suficiente.

Para essa finalidade a caldeira possui um by-pass automático que regula uma correcta vazão de água no permutador de aquecimento em qualquer condição da instalação.

First speed = primeira velocidade

Second speed = segunda velocidade

Third speed = terceira velocidade

**[SRB] Raspoloživi napor****A= Protok (l/h)****B= Raspoloživi napor (mbar)**

Raspoloživi napor za instalaciju grejanja predstavljen je, ovisno o protoku, grafikonom sa strane.

Proračun cevi za grejanje treba izvršiti vodeći računa o raspoloživom naporu.

Imajte u vidu da kotao pravilno funkcioniše ako u izmjenjivaču grejanja postoji dovoljna cirkulacija vode.

Zbog toga je kotao opremljen automatskim by-passom koji omogućuje regulaciju pravilnog protoka vode u izmjenjivaču grejanja.

First speed = prva brzina

Second speed = druga brzina

Third speed = treća brzina

**[TR] Sirkülator kalıntı başlığı****A= Kapasite (l/sa)****B= Başlık (mbar)**

Isıtma sistemi kalıntı başlığı bir sonraki grafikte, kapasitesine göre gösterilmiştir.

Isıtma sistemi boru boyutlandırılması, uygun kalıntı başlığı değeri göz önünde bulundurularak yapılmalıdır.

Kombinin, ısı eşanjöründeki su sirkülasyonu yeterliyse düzgün çalıştığını unutmayın.

Bu amaçla kombi, ısı eşanjöründeki su kapasitesi her sistem koşulunda düzenli bir biçimde ayarlayan otomatik by-pass ile donatılmıştır.

İlk hız

İkinci hız

Üçüncü hız

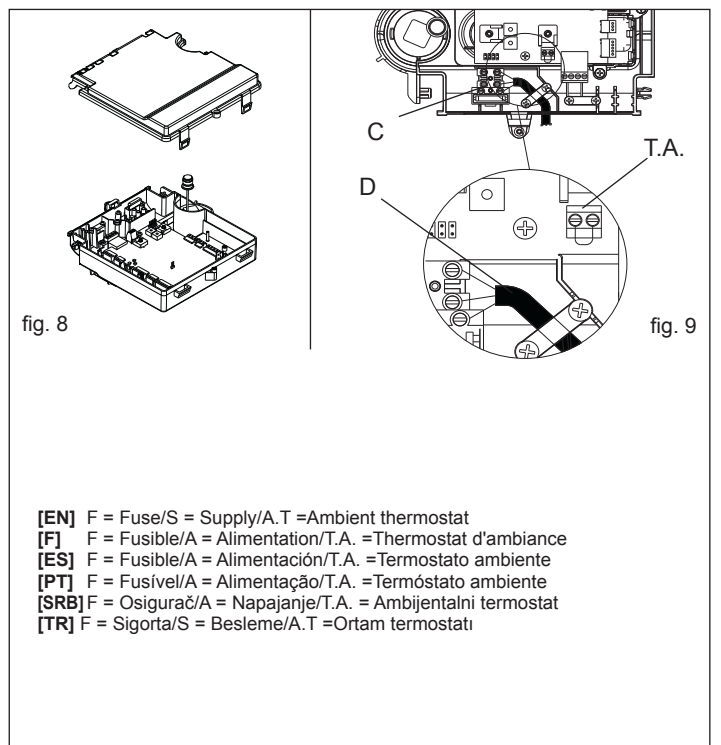
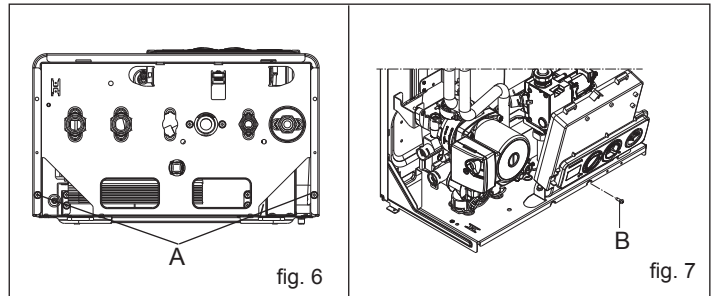
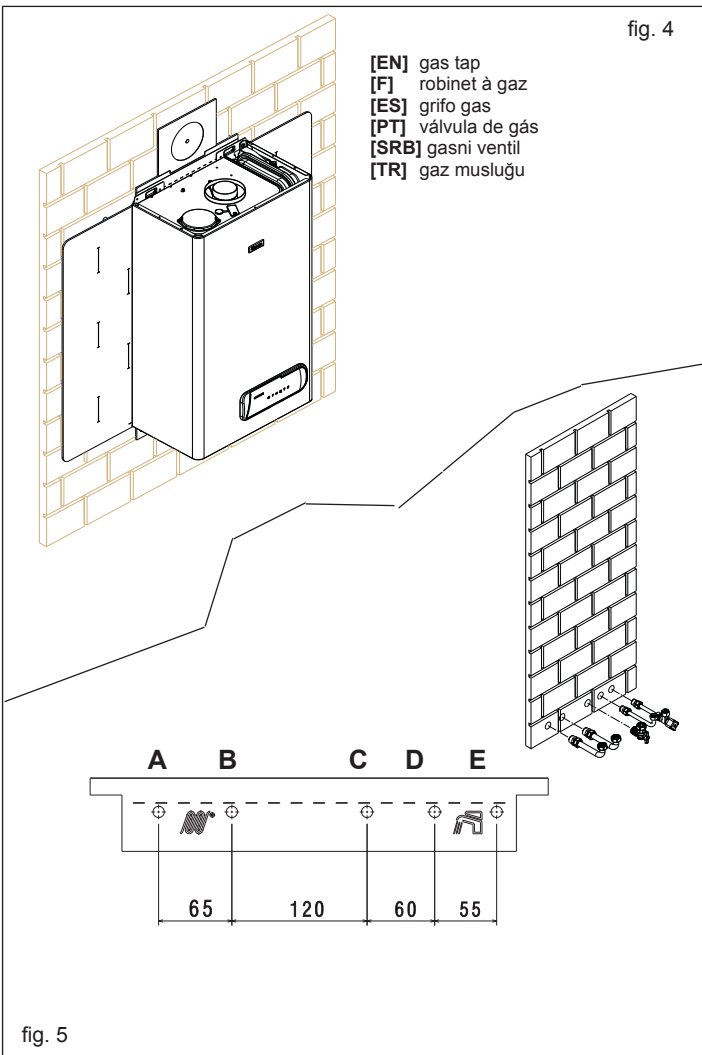
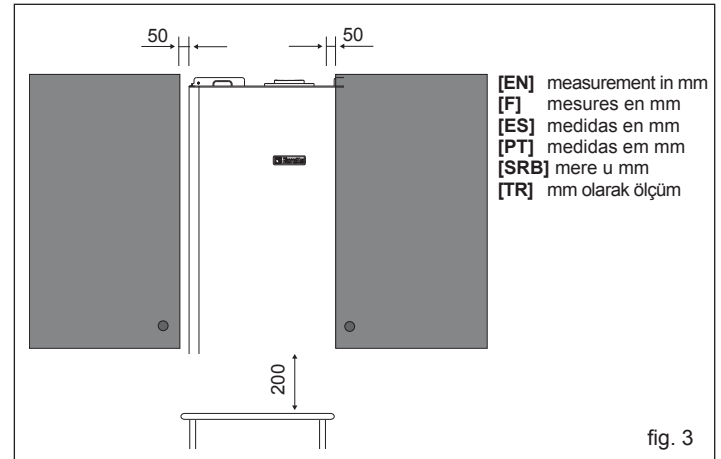
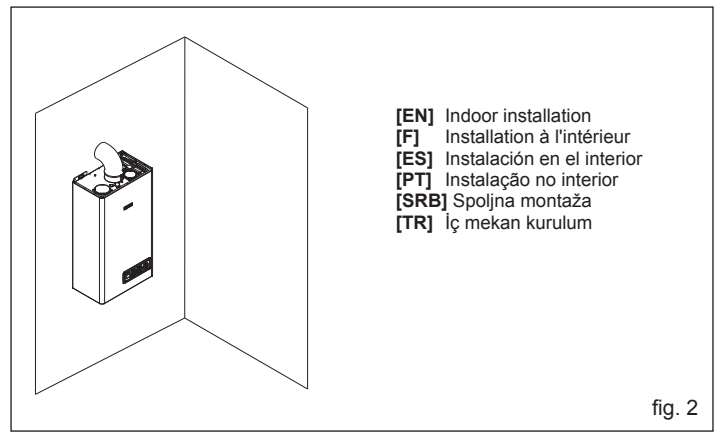
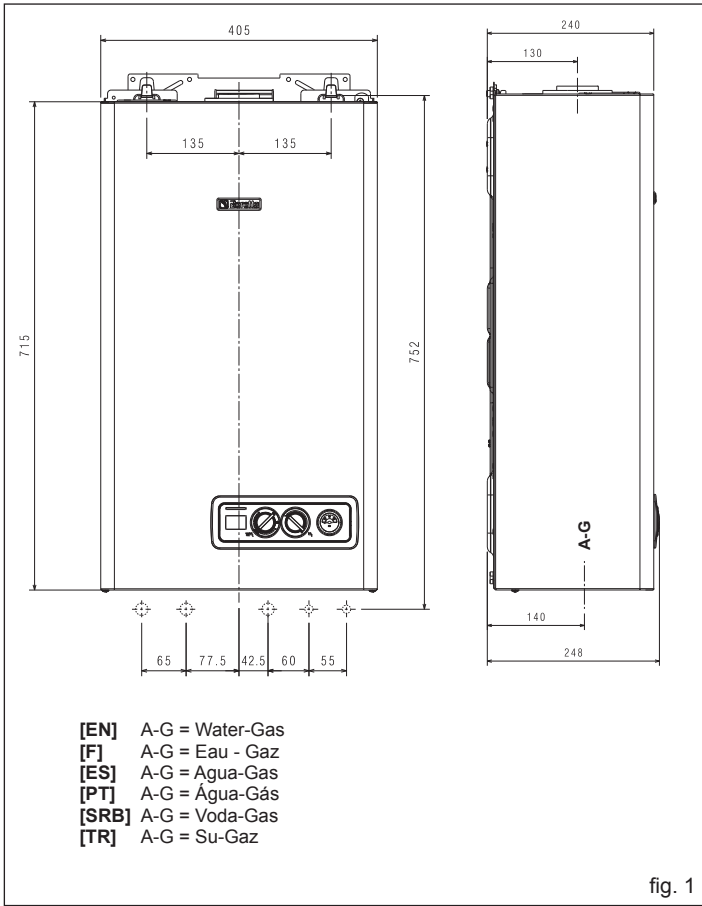



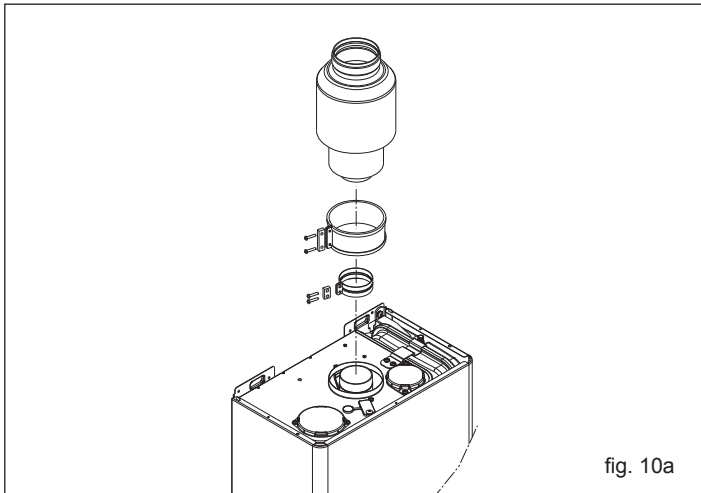

fig. 10a

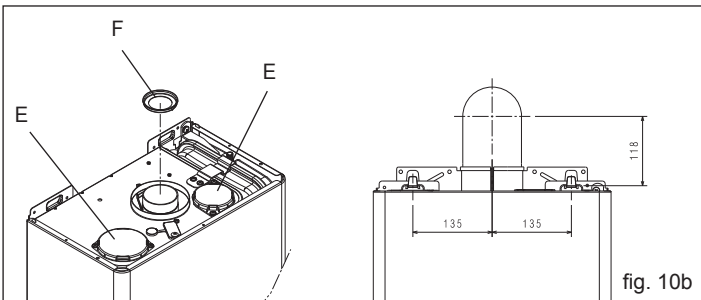

fig. 10b

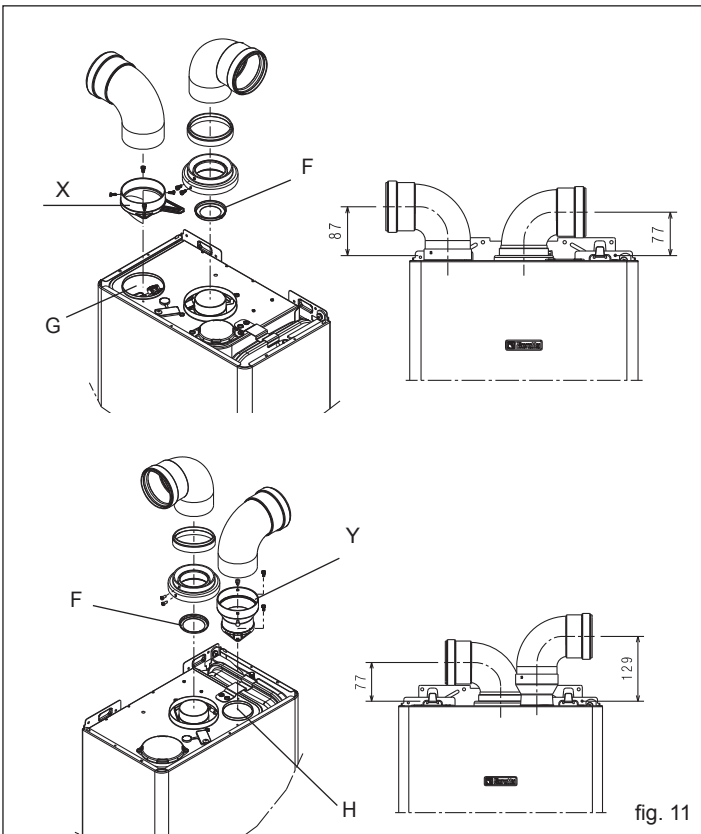

fig. 11

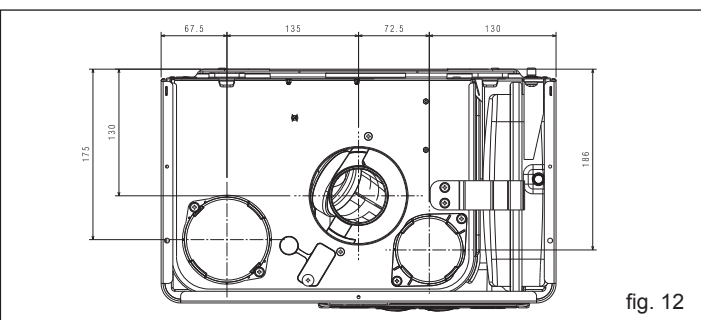

fig. 12

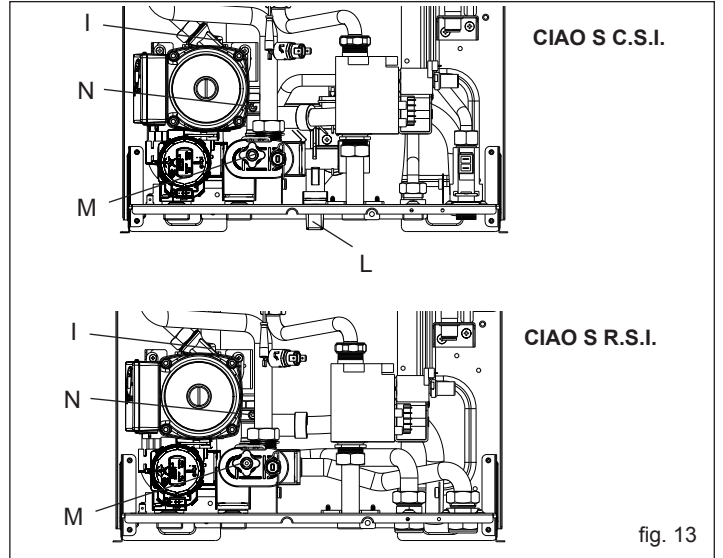

fig. 13

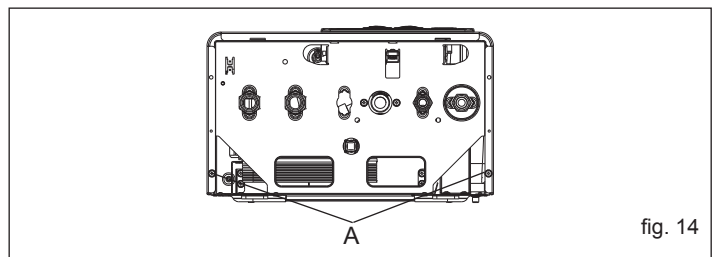

fig. 14

- [EN] A - COMPENSATION TAP/ B - PRESSURE TUBE / C - SAFETY CAP / D - FASTON CONNECTORS / E - MAXIMUM POWER ADJUSTING NUT / F - ALLEN SPANNER FOR ADJUSTING THE DOMESTIC HOT WATER MINIMUM
- [F] A - PRISE DE COMPENSATION (MODÈLE C.S.I.) / B - PRISE DE PRESSION EN AVAL DU ROBINET DE GAZ / C - CAPUCHON DE PROTECTION / D - RACCORDEMENTS FASTON / E - ÉCROU DE RÉGLAGE DE LA PUISSANCE MAXIMUM / F - VIS A SIX PANS CREUX POUR LE REGLAGE DU MINIMUM SANITAIRE
- [ES] A - TOMA DE COMPENSACIÓN (MODELO C.S.I.) / B - TOMADA PRESIÓN SITUADA DESPUÉS DE LA VÁLVULA GAS / C - CAPUCHÓN DE PROTECCIÓN / D - CONEXIONES FASTON / E - TUERCA DE REGULACIÓN MÁXIMA POTENCIA / F - TORNILLO ALLEN PARA LA REGULACIÓN DEL MÍNIMO SANITARIO
- [PT] A - TOMADA DE COMPENSAÇÃO (MODELO C.S.I.) / B - TOMADA DE PRESSÃO A JUSANTE DA VÁLVULA DE GÁS / C - CAPUZ DE PROTECÇÃO / D - JUNÇÕES FASTON / E - PORÇA DE REGULACÃO POTÊNCIA MÁXIMA / F - PARAFUSO ALLEN PARA A REGULACÃO DO MÍNIMO SANITÁRIO
- [SRB] A - PRIKLJUČAK ZA KOMPENZACIJU (SAMO C.S.I.) / B - PRIKLJUČAK ZA MJERENJE PRITISKA IZ GASNOG VENTILA / C - ZAŠTITNA KAPICA / D - PRIKLJUČCI FASTON / E - MATICA ZA REGULACIJU MAKSIMALNE SNAGE / F - SREDSTVO ZA REGULACIJU MINIMALNE SANITARNE VREDNOSTI
- [TR] A - DENGELEME MUSLUĞU / B - BASINÇ BORUSU / C - GÜVENLİK KAPAĞI / D - FASTON KONEKTÖRLERİ / E - MAKSİMUM GÜÇ AYARLAMA SOMUNU / F - MİNİMUM ŞEBEKE SUYU AYARI İÇİN ALYAN ANAHTARI

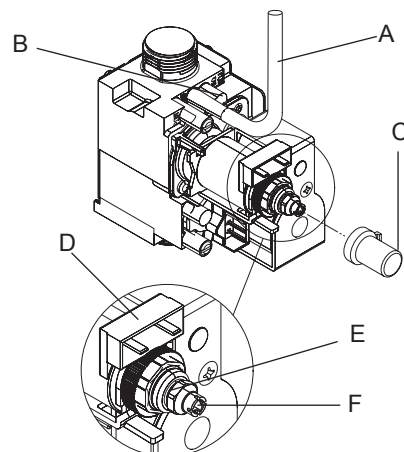
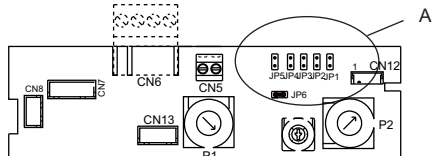

fig. 15



[EN]  
**JP1** Bridge to enable function calibration  
**JP2** Bridge to adjust maximum heating  
**JP3** Bridge to select MTN-LPG

[F]  
**JP1** Shunt activation fonction de réglage  
**JP2** Shunt réglage de chauffage maximum  
**JP3** Shunt sélection MTN-GPL

[ES]  
**JP1** Puente habilitación función regulación  
**JP2** Puente regulación de la máxima calefacción  
**JP3** Puente selección MTN - GLP

[PT]  
**JP1** Ponte habilitação função calibragem  
**JP2** Ponte regulação máximo aquecimento  
**JP3** Ponte selecção MTN-GPL

[SRB]  
**JP1** Ograničenje funkcije mosta podešavanje  
**JP2** Regulacija mosta maksimalno zagrevanje  
**JP3** Most izaberite MTN-GPL

[TR]  
**JP1** Fonksiyon kalibrasyonunu etkinleştirmek için köprü  
**JP2** Maksimum ısıyı ayarlamak için köprü  
**JP3** MTN - LPG seçen köprü

fig. 16

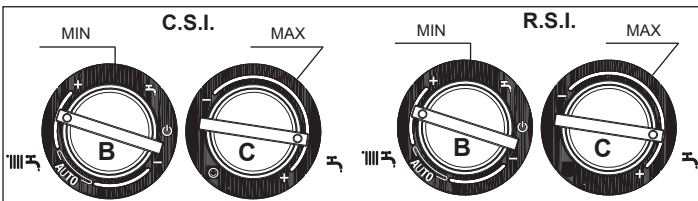

[EN] MIN heating minimum calibration  
 MAX heating maximum calibration

[F] MIN. réglage de chauffage minimum  
 MAX. réglage de chauffage maximum

[ES] MÍN regulación mínima calefacción  
 MÁX regulación máxima calefacción

[PT] MÍN. calibragem mínimo aquecimento  
 MÁX. calibragem máximo aquecimento

[SRB] MIN podešavanje minimuma grejanja  
 MAX podešavanje maksimuma grejanja

[TR] MİN ısıtma minimum kalibrasyonu  
 MAKS ısıtma maksimum kalibrasyonu

fig. 17

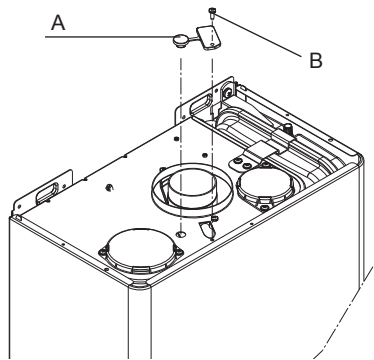

[EN]  
**A** cover  
**B** screw

[F]  
**A** couvercle  
**B** vis

[ES]  
**A** tapa  
**B** tornillo

[PT]  
**A** tampa  
**B** parafuso

[SRB]  
**A** omot  
**B** vite

[TR]  
**A** kapak  
**B** vida

fig. 18

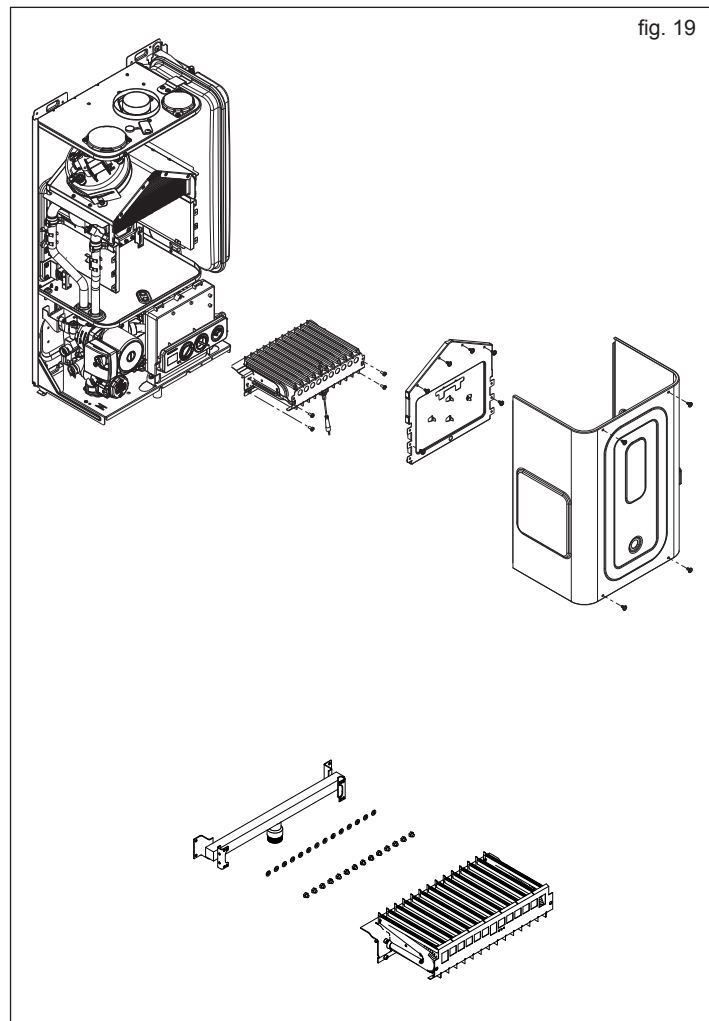

fig. 19

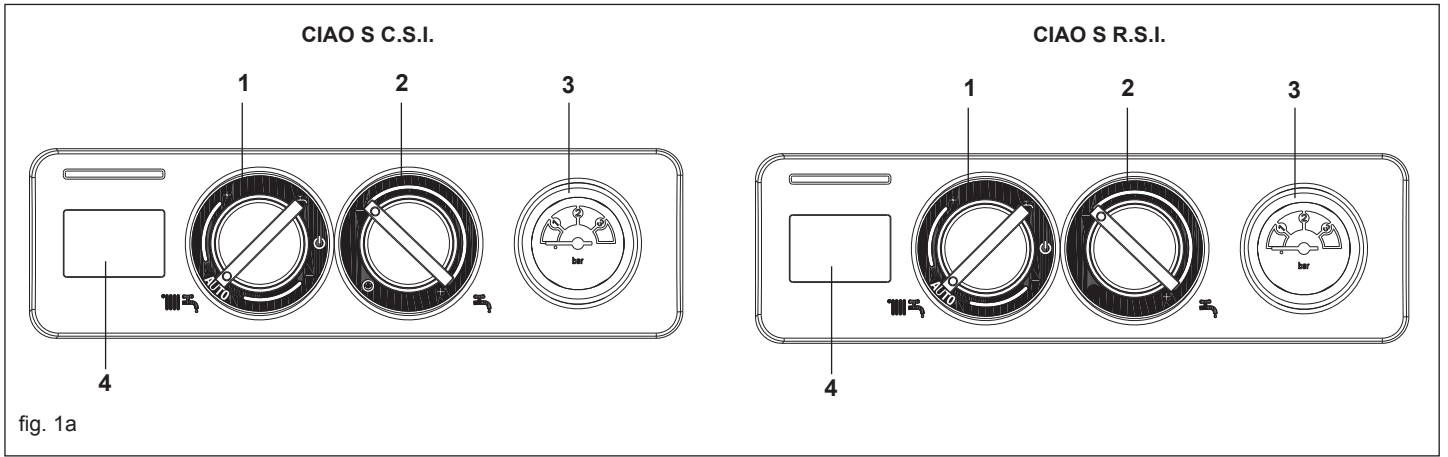

fig. 1a

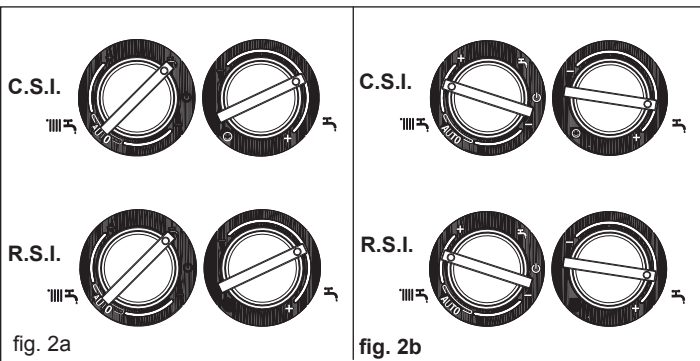

fig. 2a

fig. 2b

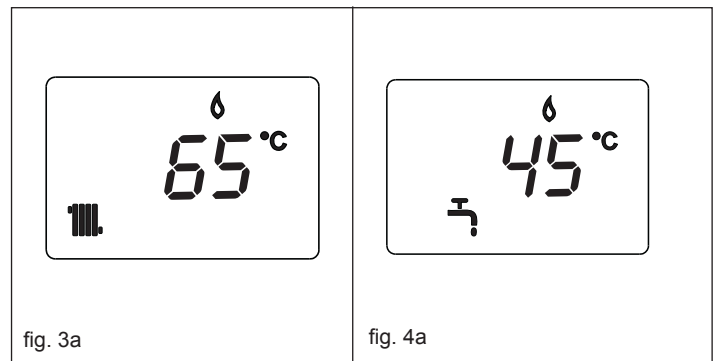

fig. 3a

fig. 4a

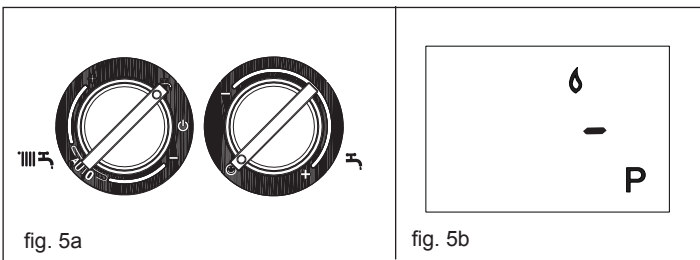

fig. 5a

fig. 5b

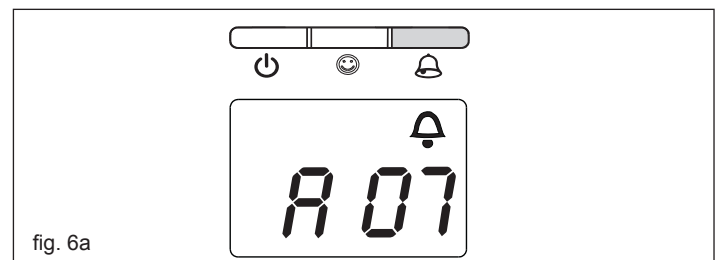

fig. 6a

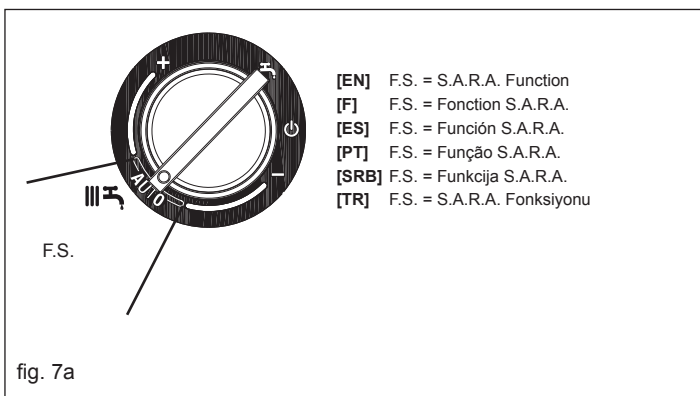

fig. 7a

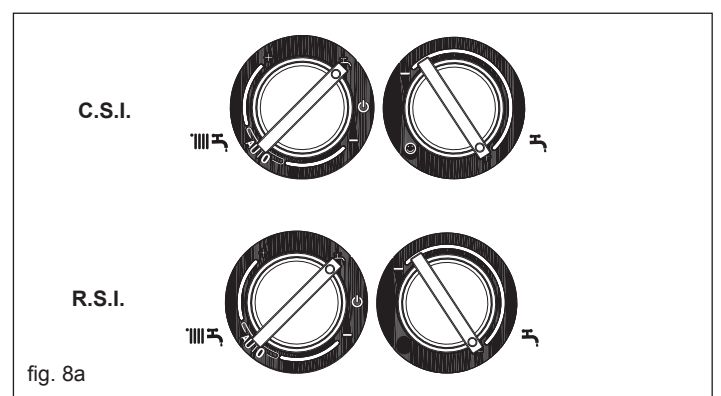

fig. 8a

Commercial Offices: Via Risorgimento, 23 A  
23900 - Lecco

[www.berettaboilers.com](http://www.berettaboilers.com)

Beretta reserves the right to modify the characteristics and specifications given in this publication at any time and without prior notice as part of its policy of continuous product improvement. This publication cannot therefore be understood as a contract with third parties.

