



  
carisa®

**DESIGNER  
RADIATORS  
2018  
2019**



The World is changing, also **the heating technology...**

We live in a world where adding value is crucial and increasingly difficult to achieve. Value can only be added if you, or what you possess, contain elements of unrivaled esteem.

Design and technology are two important tools for gaining such additional value in life.

In business, building competitive advantage in our increasingly fast-moving, information-rich world of global access is not easy and technology alone is not enough. Today's biggest winners went beyond using technology for its own sake. Instead, they used design to simplify technology, delivering it to consumers in a way that is meaningful, engaging, and easy to use.

Design-led businesses use design to create distance from their competitors. It gives their customers a compelling reason to purchase their products.

These businesses do not stand still. They always look for a better way because they know that their uniqueness is their competitive advantage - just like our invention, CARISA.

CARISA is a brand distributed by Carisa Radiators Ltd. in UK that unites innovation and design, primarily in heating. CARISA has been created by the experienced and innovative team at Carisa Radiators who have maintained a successful reputation over the past **40 years** in the heating industry. CARISA heating units, towel rails, radiators and decorative accessories are a combination of in-vogue and technological ideas, thanks to the engineering and design team who share all of their inventions with you.

Today, with the advent of CARISA, heating has become so elegant and even more functional. CARISA radiators have been used in a wide variety of existing architectural developments and complexes worldwide.

Working intentionally with a broad range of architects, CARISA has established loyal architectural partnerships on a number of large projects.

CARISA is pleased to present its complete range of products, with a vast variety of radiators and accessories.

Different models, sizes, and colors will provide you with endless solutions.

**20** YEARS EXPERIENCE IN UK  
with OEM production for well known brands...

L O N D O N  
P A R I S  
N E W Y O R K  
A M S T E R D A M  
D U S S E L D O R F  
I S T A N B U L  
B R U S S E L S  
M I L A N  
B A R C E L O N A  
L I S B O N  
T U N I S  
B E I R U T  
B A K U  
T E H R A N  
F R A N K F U R T  
S T O C K H O L M  
P R A G  
B E R L I N  
B I R M I N G H A M  
D U B L I N  
K E N T





## why carisa

### WHY CARISA ALUMINIUM DESIGNER RADIATORS ?

Lightness, high conductivity of heat and longevity earns our aluminium radiators their unique place among the other Carisa products we produce.

Aluminium has three times more heat conductivity compared to mild steel. This helps it conserve high levels of energy, using only minimal water.

#### **WEIGHT**

Helps against unnecessary weight in buildings. Being 70% lighter than mild steel, it's easy to transport and assemble.

#### **HIGH LEVEL OF PRESSURE RESISTANCE**

Safe to use even in high buildings due to strong hydrostatic resistance capacity.

#### **SMOOTH SURFACE**

Very easy to clean and maintain thanks to its anodized coating or tribo paint.

#### **UNIQUE DESIGN**

Adds value to any room due to its appeal for perfectionists.

#### **LIMITLESS COLOUR OPTIONS**

Available in many different colours and anodized or even wooden effects.

#### **EXTRUDED CONSTRUCTION**

Joint with extrusion technique, it's reliable and long lasting.

#### **FLEXIBLE SIZES FOR CUSTOM MADE MEASUREMENTS**

Available in sizes between 200-3000 mm high and upto 3000 mm in width.

#### **CAN ACCOMMODATE ANY CONNECTION**

Can fit to any preferred connection type.

#### **AN ENVIRONMENTALLY FRIENDLY PRODUCT**

Aluminium is an 100% recyclable material, by nature.

#### **A HIGH QUALITY PRODUCT**

5 Years of Guarantee against manufacture defects and leakage.

### WHY CARISA STAINLESS STEEL DESIGNER RADIATORS ?

The world's best radiator designers use world class materials, and there are few better than Stainless Steel. The knowledge that your radiator is protected from defects or corrosion, as well as longer guarantees leave you feeling as fine as the radiator itself.

Whether the metal is polished to a mirror surface, or brush treated for a real treat, Stainless Steel radiators offer the best of both worlds with a gorgeous, modern aesthetic as well as the fortitude and quality to stand the test of time.

All towel rails and radiators are constructed from 100% stainless steel. There are no chemical plating processes in the manufacture of stainless steel. Because of the lack of plating stainless steel rails will not rust, flake or corrode and small marks can be polished out, making this a durable choice. It is made from over 90% recycled materials and is 100% recyclable itself.

Carisa Range of towel rails are polished to a high finish and will last a lifetime. They are manufactured from 304 grade stainless steel with 316 welds and with no known health risks and totally hygienic you are making the ethical and durable choice. Carisa's design team has created a unique range of radiator models that will enhance any kind of interior.

Only the highest grade solid stainless steel is used for Carisa Designer Radiators. All joints are welded with the advanced 'Tig Welding' technique using argon gas to avoid leakage. All of Carisa products are tested to 13 bars minimum. Pickling and passivation process is applied to all Carisa towel rails and radiators after welding.

All radiators are handmade by skilled craftsman and each appliance passes a quality control test on completion.

Carisa Radiators is producing stainless steel radiators since 2001 in Turkey



Low water content technology is used in all Carisa Aluminium Radiators. Modern Heating Technology is used in Carisa products since 2005. Low water content is one of the most necessary points, while creating all new Carisa products. Success of isolation industry is one of the most important assistance for heating industry to develop the Modern Heating Technology...

### WHY CARISA MILD STEEL DESIGNER RADIATORS ?

The most important part of a company who has a wide vision is to manufacture compatible products that can satisfy today's variable tastes. The accessories we use in our bathrooms and houses in general should also reflect contemporary tastes. Steel bathroom radiators and steel radiators are one of the most important parts of our house decoration. Carisa Steel Radiators and Bathroom Radiators with its above standard designs are being manufactured under International Quality Standards and presented to its customers use. Carisa Design Radiators, experience meets elegance

## STOCK PRODUCTS

Product	Material	page	tech & price
ADAGIO	Stainless Steel	03	125
ADORE	Stainless Steel	85	142
ALDO	Steel	102	146
ANTARA	Steel	100	146
AJAX HI	Aluminium	57	135
ALIAS	Stainless Steel	84	142
AREN	Stainless Steel	73	139
ARLEN	Stainless Steel	88	142
BARKOD	Steel	110 - 111	148
BARO	Stainless Steel	71	138
BARON	Aluminium	56	135
CRUX	Stainless Steel	70	138
DORA	Stainless Steel	114	149
ECLIPSE	Stainless Steel	93	144
ECLYPSIA	Aluminium	59	136
EDWARD	Traditional Steel	109	148
ELITE	Aluminium	36 - 37	131
ELLIPTIC	Aluminium	30 - 31	130
ELLIPTIC BATH	Aluminium	52	134
ELVINO	Aluminium	16 - 17	128
ELVINO BATH	Aluminium	50	133
ELVINO BATH MIRROR	Aluminium	61	136
ELVINO FLOOR	Aluminium	49	133
ETAGE	Steel	106	147
FLORIS	Steel	96	145
FAME	Aluminium	53	134
FAME HORIZONTAL	Aluminium	54	134
FORTUNA	Stainless Steel	63	137
FRAME	Steel	94	144
GAIA	Aluminium	12 - 13	127
GRADIENT	Steel	97	145
HALO	Stainless Steel	68	138
HERRING	Stainless Steel	87	143
IBIZA	Stainless Steel	89	143
IGUANA	Stainless Steel	90	143
IVOR	Stainless Steel	83	142
JACK	Stainless Steel	76	140
JAZZ	Stainless Steel	81	141
KARE	Stainless Steel	86	141
KARO	Aluminium	06	126
KLIPS	Stainless Steel	91	144
LEPUS	Stainless Steel	75	139
LINK	Stainless Steel	77	140
MATE	Aluminium	55	135
MAYRA	Steel	112 - 113	149
MISTRAL	Stainless Steel	62	136
MONZA DOUBLE	Aluminium	26 - 27	129
MONZA	Aluminium	28 - 29	130
MOTION	Aluminium	08 - 09	126
NEMO DOUBLE	Aluminium	22 - 23	129
NEMO	Aluminium	24 - 25	129
MONZA BATH	Aluminium	60	136
NERO	Steel	103	147
NILE	Steel	115	149
NIXIE	Aluminium	20 - 21	128
NIXIE BATH	Aluminium	51	134
OTTO	Aluminium	10 - 11	127
PAROS	Stainless Steel	72	139
PLAY	Aluminium	32 - 33	130
PRIMUS	Steel	98	145
QUADRO	Aluminium	04	125
REDOX	Stainless Steel	74	139
RONI	Stainless Steel	79	141
RUBIN	Steel	99	146
SARP	Stainless Steel	64 - 65	137
SNOWFLAKE	Stainless Steel	92	144

# ALPHABETIC INDEX

Product	Material	page	tech & price
SOHO	Aluminium	58	135
SOPHIA	Aluminium	44 - 45	132
SOPHIA XL	Aluminium	46	132
SOPHIA MIRROR	Aluminium	47	133
STEP	Aluminium	34 - 35	131
STEP MIRROR	Aluminium	05	125
STRIPE	Stainless Steel	66 - 67	137
SWING	Stainless Steel	78	140
TALENT	Stainless Steel	80	141
TALLIS	Aluminium	38 - 39	131
TALLIS DOUBLE	Aluminium	40 - 41	132
TALLIS MIRROR	Aluminium	48	133
TALLIS XL	Aluminium	42	132
TALLIS DOUBLE XL	Aluminium	43	132
TANYA	Steel	101	146
THOR	Steel	95	145
TUBO	Aluminium	07	126
VALENCIA	Steel	104	147
VECTOR	Steel	69	138
VERONA	Steel	105	147
VESTA	Aluminium	14 - 15	127
VICTORIA	Traditional Steel	107	148
VINTAGE	Traditional Steel	108	148
VIVI	Stainless Steel	82	142
WAVE	Aluminium	18 - 19	128

## ACCESSORIES

158-159

## 4 - 6 WEEKS DELIVERY BESPOKE PRODUCTS

Product	Material	page	tech & price
UNIQUE	Stainless Steel	116	150
TRIA	Stainless Steel	116	150
SQUA	Stainless Steel	116	150
PIANO	Stainless Steel	117	150
APRIL	Stainless Steel	117	151
ABAKO	Stainless Steel	117	151
ARCO	Stainless Steel	117	151
ZIGZAG	Stainless Steel	118	152
PIAZZE	Stainless Steel	118	152
WOODSTOCK	Stainless Steel	118	152
GRACE	Stainless Steel	118	152
CLASICO	Stainless Steel	119	153
UNA	Stainless Steel	119	153
PAN	Stainless Steel	119	153
DOMINO	Stainless Steel	119	153
CLASH	Stainless Steel	120	154
BECK	Stainless Steel	120	154
FLAP	Stainless Steel	120	154
RUMA	Stainless Steel	120	154
TODOR	Stainless Steel	121	155
EXODUS	Stainless Steel	121	155
CASTOR	Stainless Steel	121	155
ENVIRON	Stainless Steel	121	155
ORIS	Stainless Steel	122	156
VERSAILLES	Stainless Steel	122	156
FORTE	Stainless Steel	122	156
FUTURA	Stainless Steel	122	156
KEOPS	Stainless Steel	123	157
HERMES	Stainless Steel	123	157
CALISTA	Stainless Steel	123	157

# ADAGIO

LIMITED EDITION

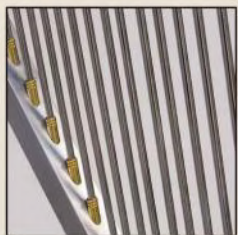

*A piece of art...*

This product will be the master piece  
of your interior.  
It is made of polished and brushed stainless steel  
with gold plated brass rings.

The Adagio radiator is limited edition  
and it is certificated.

# QUADRO



125

New

ALUMINIUM DESIGNER RADIATORS



STEP MIRROR

KARO



126



# TUBO





New

ALUMINIUM DESIGNER RADIATORS



MOTION



OTTO



# GAIA



127







# VESTA

ALUMINIUM DESIGNER RADIATORS





128



ELVINO





WAVE

NIXIE

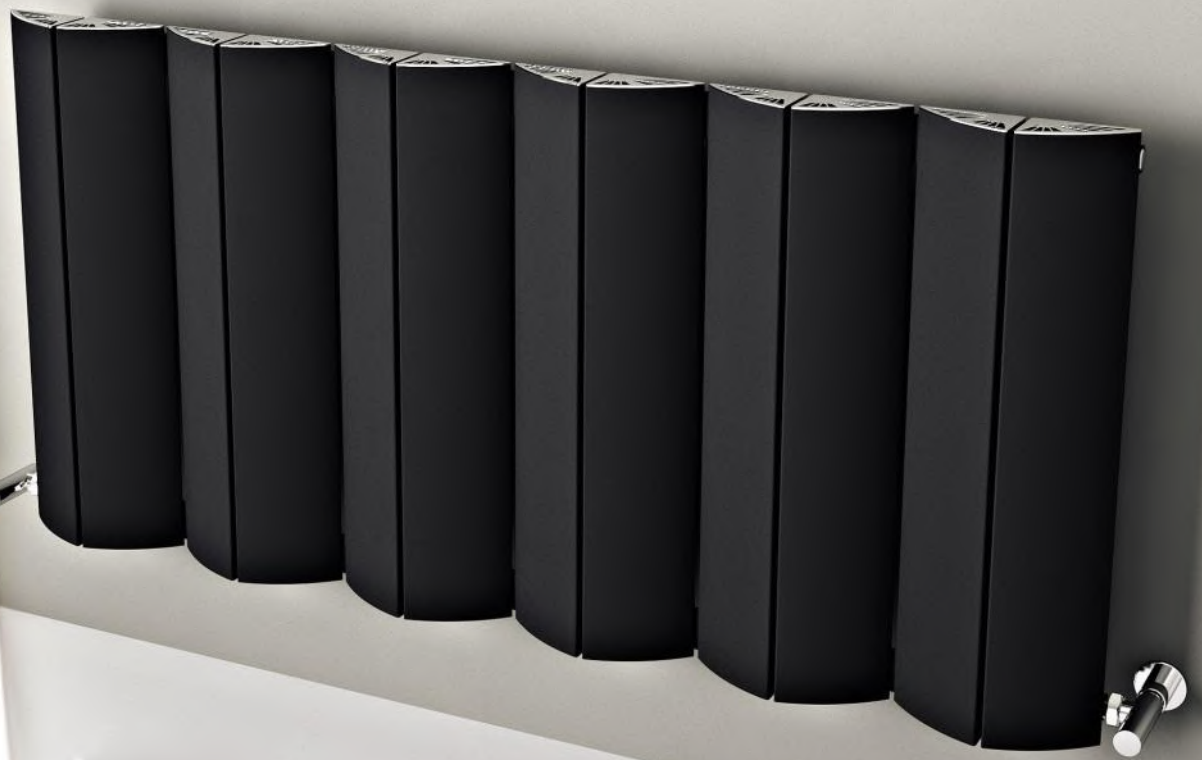



# NEMO DOUBLE







NEMO





# MONZA DOUBLE



129



MONZA



30

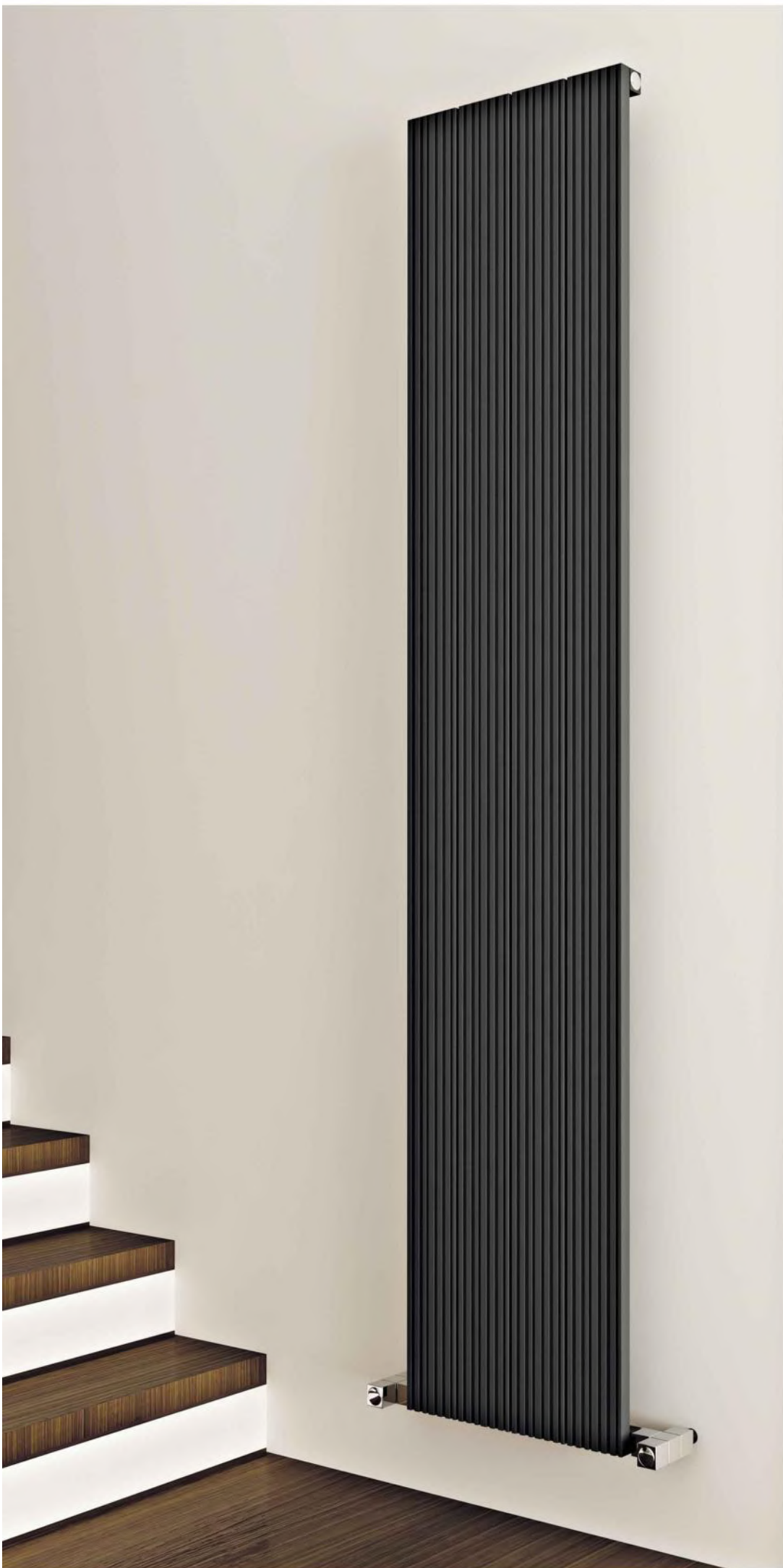





# ELLIPTIC





130

# PLAY



STEP



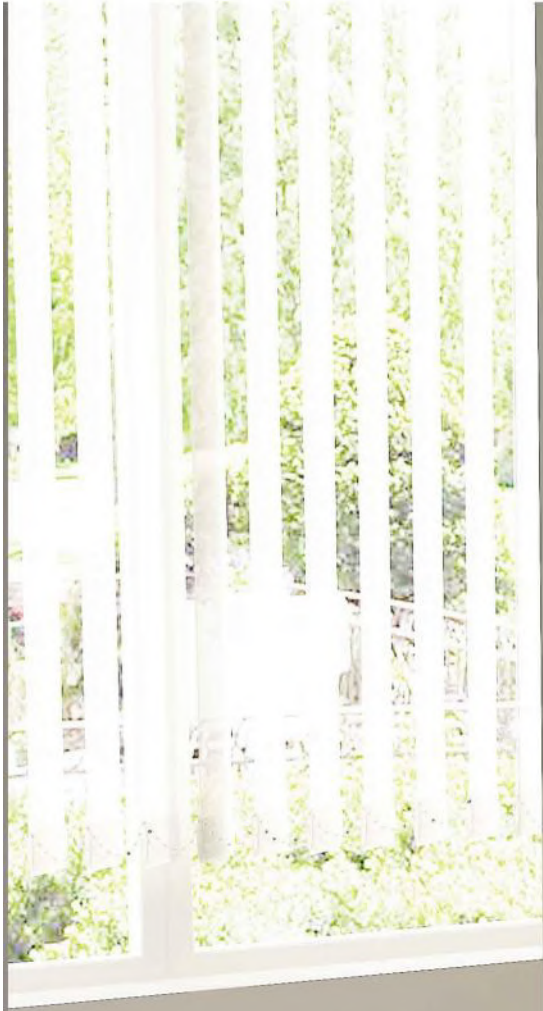

ELITE









# TALLIS



131



# TALLIS DOUBLE

ALUMINIUM DESIGNER RADIATORS



# TALLIS XL





# TALLIS XL DOUBLE

ALUMINIUM DESIGNER RADIATORS





# SOPHIA

ALUMINIUM DESIGNER RADIATORS



# SOPHIA XL







SOPHIA  
MIRROR

331



TALLIS  
MIRROR



ELVINO  
F L O O R

# ELVINO

B A T H





NIXIE  
B A T H

# ELLIPTIC

B A T H





FAME



# FAME





New

ALUMINIUM DESIGNER RADIATORS



MATE

# BARON

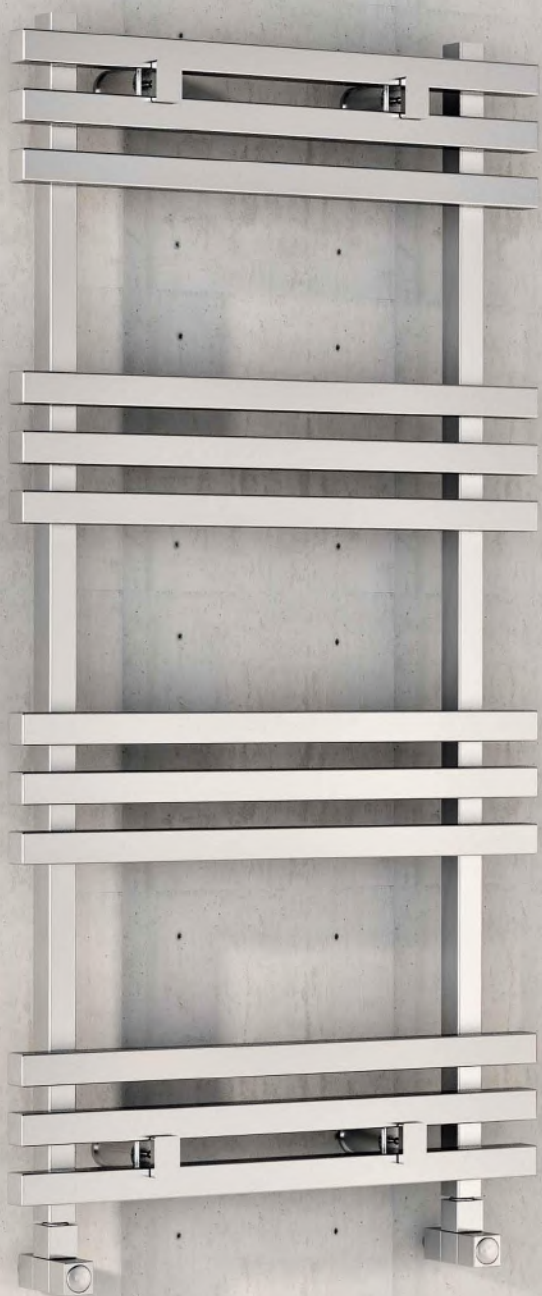

# AJAX I

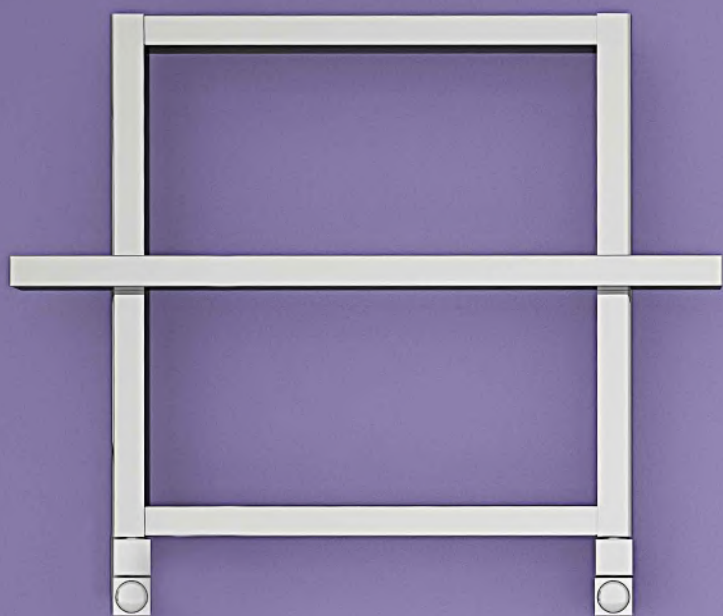

# AJAX II



SOHO



135

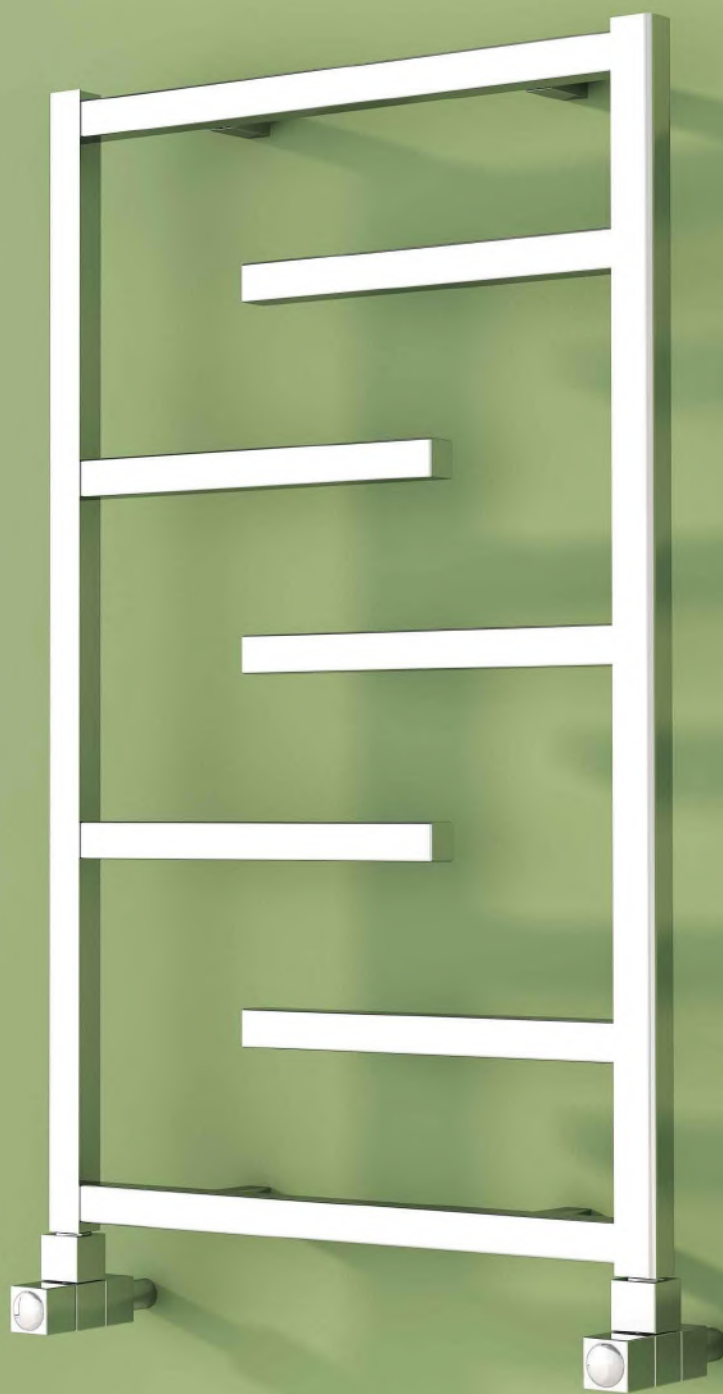

ECLYPSIA



# MONZA

B A T H



ELVINO  
BATH MIRROR



ALUMINIUM DESIGNER RADIATORS

936

# MISTRAL







FORTUNA

731

SARP





137

# STRIPE



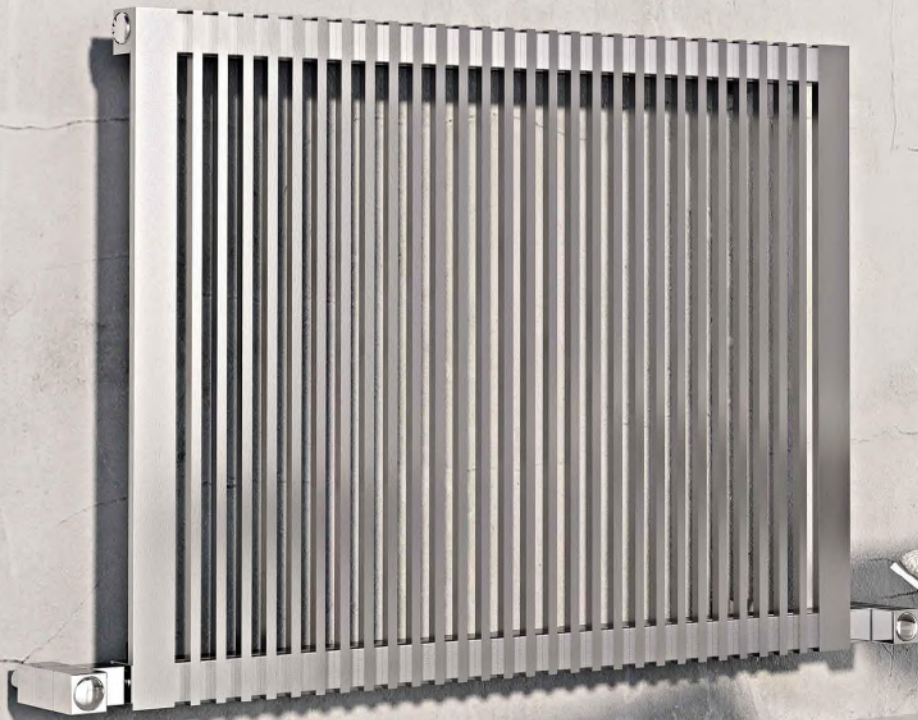

New



HALO

New

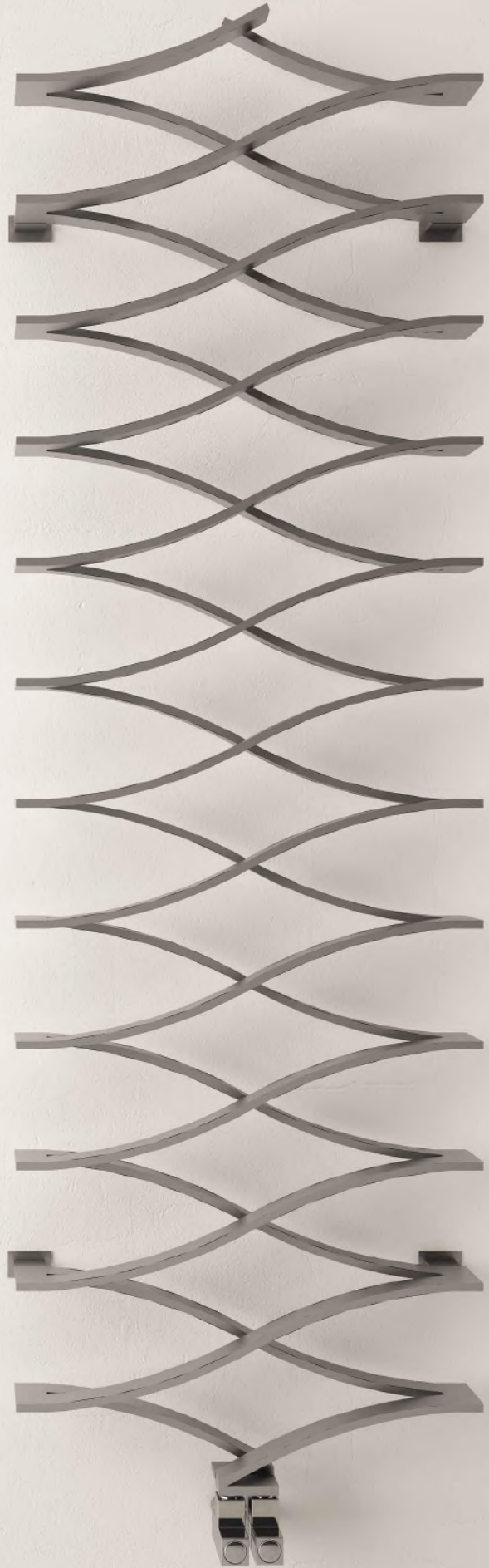

VECTOR

138

# CRUX **New**





New



BARO

891

New



PAROS

New



AREN

691

# REDOX **New**



New

LEPUS

STAINLESS STEEL DESIGNER RADIATORS



JACK

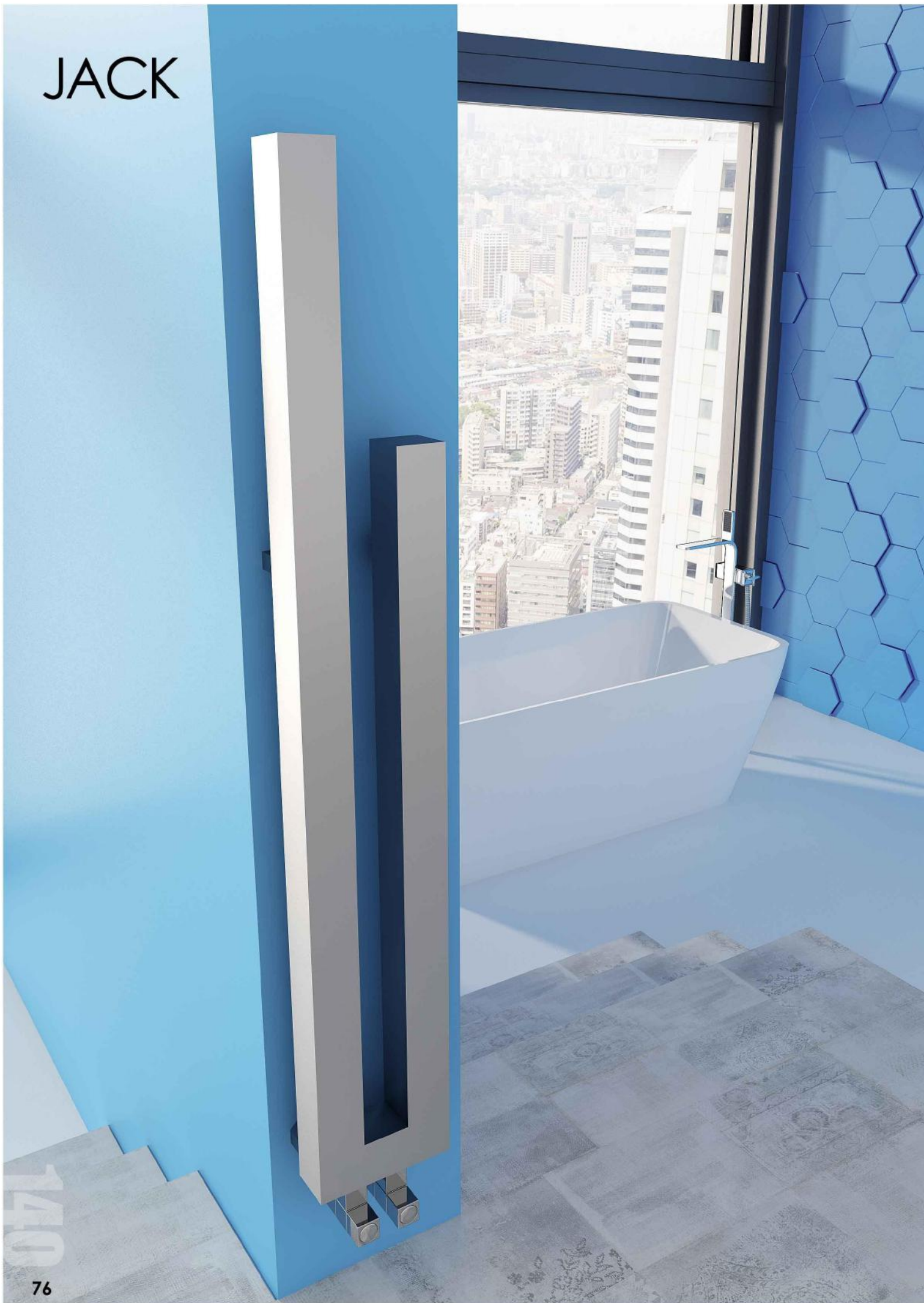

140

New



LINK

STAINLESS STEEL DESIGNER RADIATORS



140  
77

# SWING



**AWARD**  
WINNER DESIGN



RONI



# TALENT



JAZZ



VIVI





# IVOR

STAINLESS STEEL DESIGNER RADIATORS



# ALIAS





ADORE

# KARE





# HERRING

STAINLESS STEEL DESIGNER RADIATORS

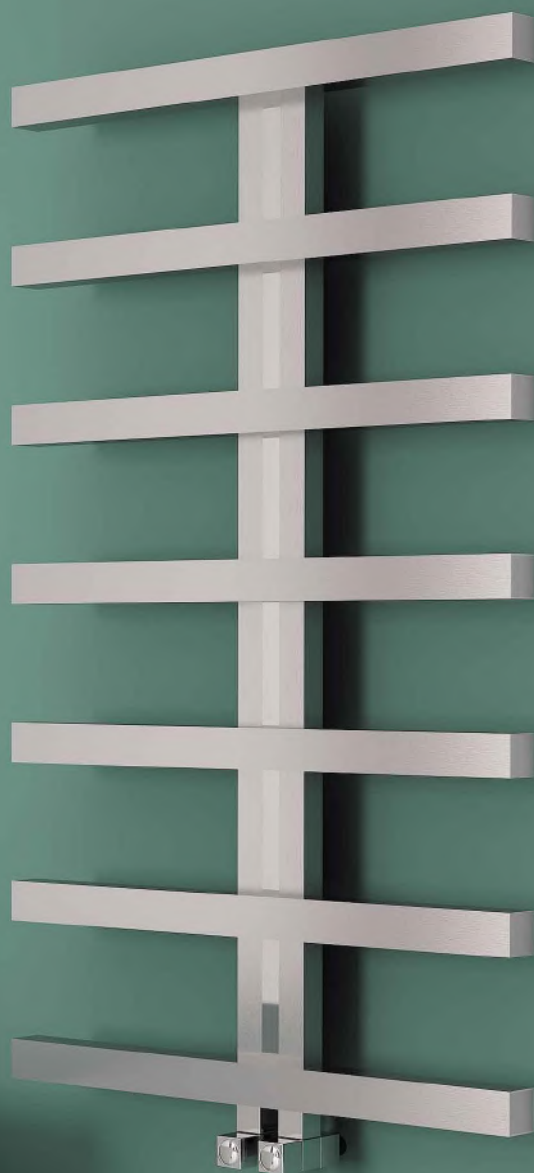

371



143

ARLEN

IBIZA



STAINLESS STEEL DESIGNER RADIATORS

143

# IGUANA



# KLIPS



# SNOWFLAKE

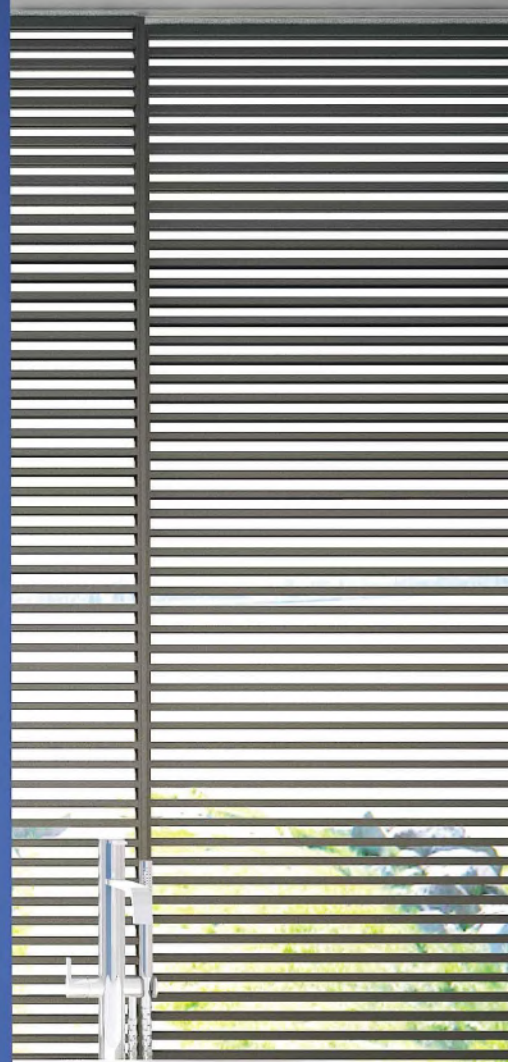

# ECLIPSE

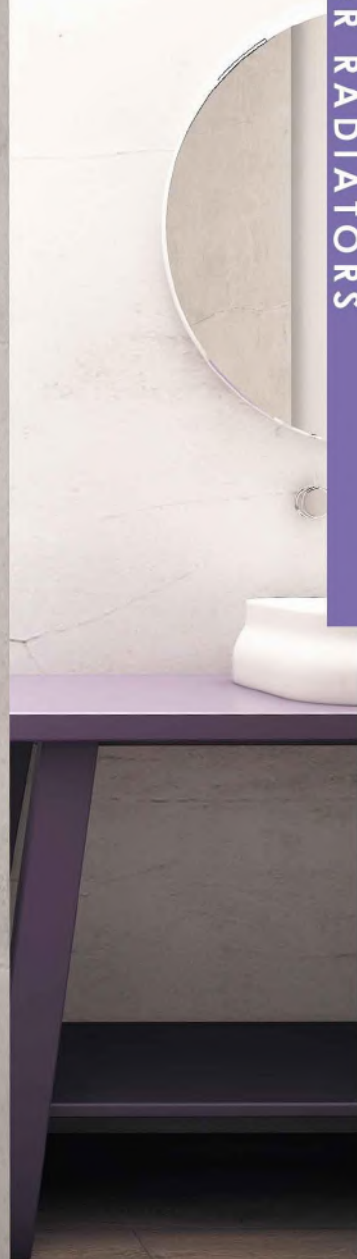
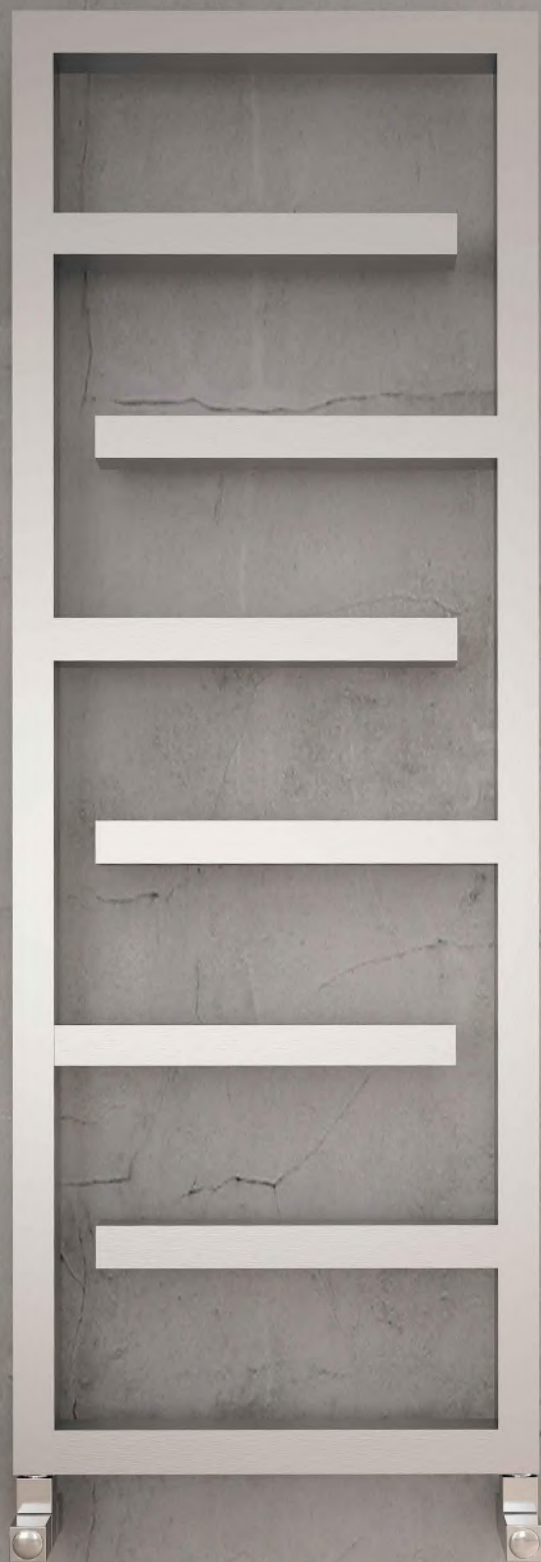

44



FRAME





THOR

145



145

96



FLORIS

# GRADIENT

STEEL DESIGNER RADIATORS



# PRIMUS

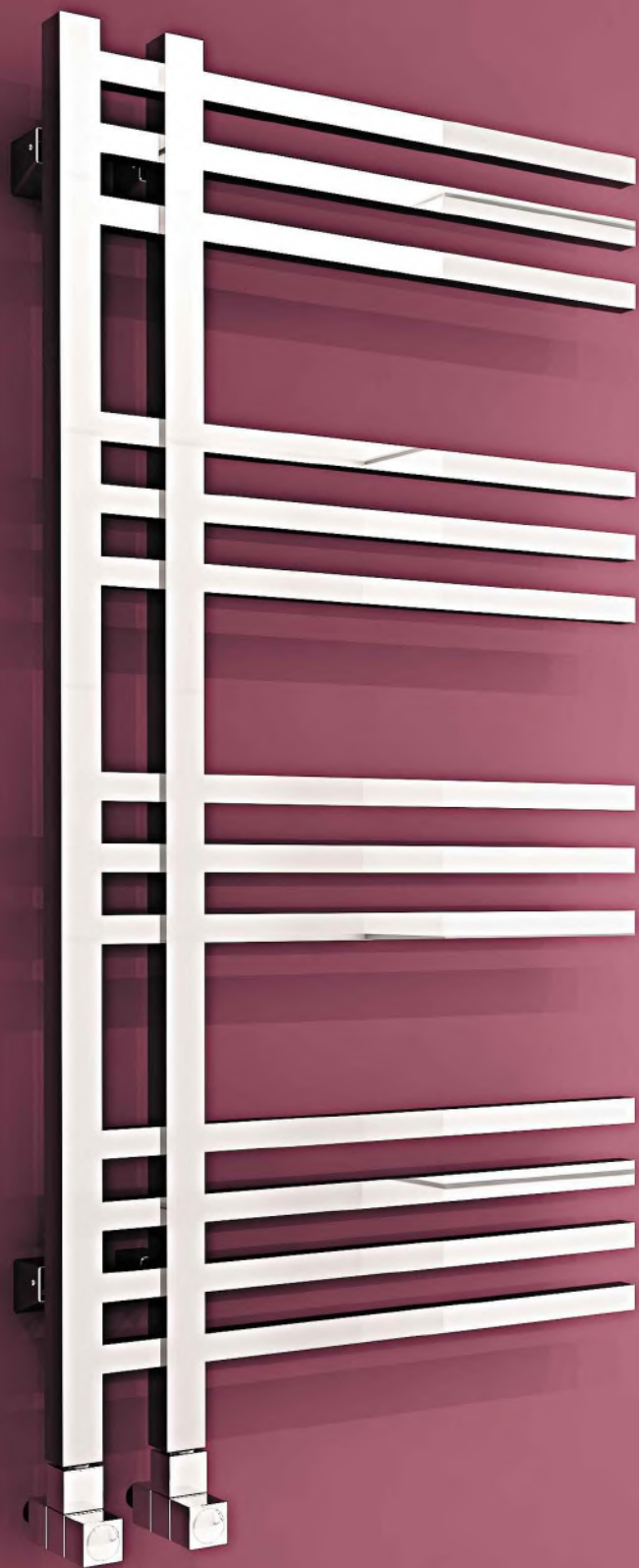

145



RUBIN

146



ANTARA

146

100

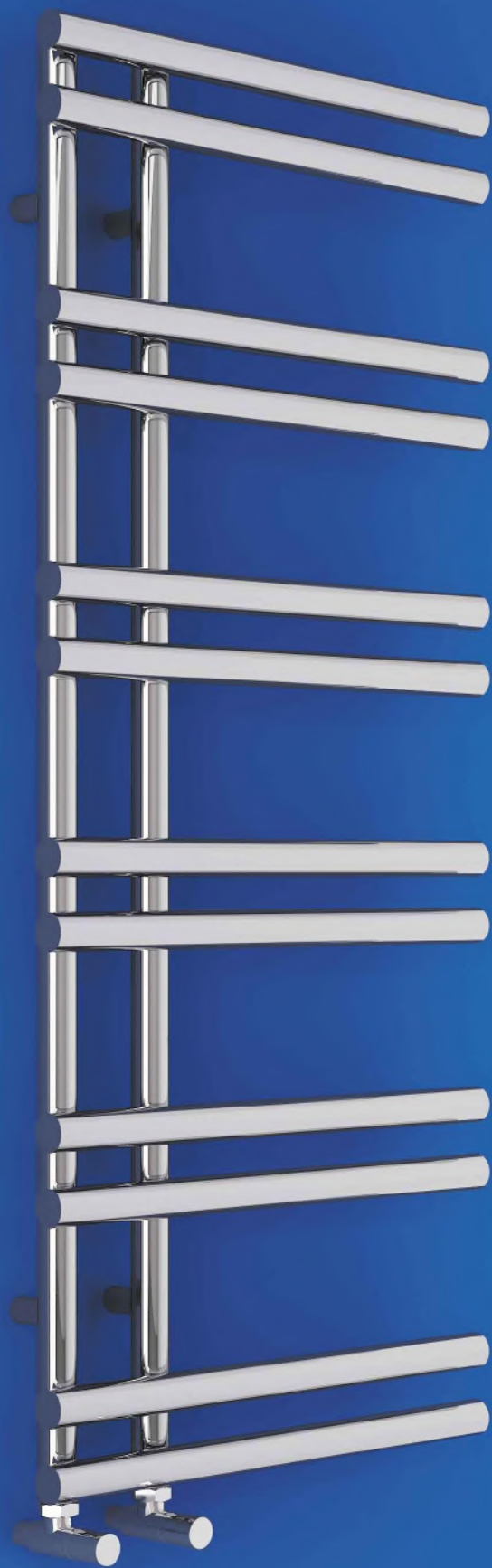

TANYA

ALDO

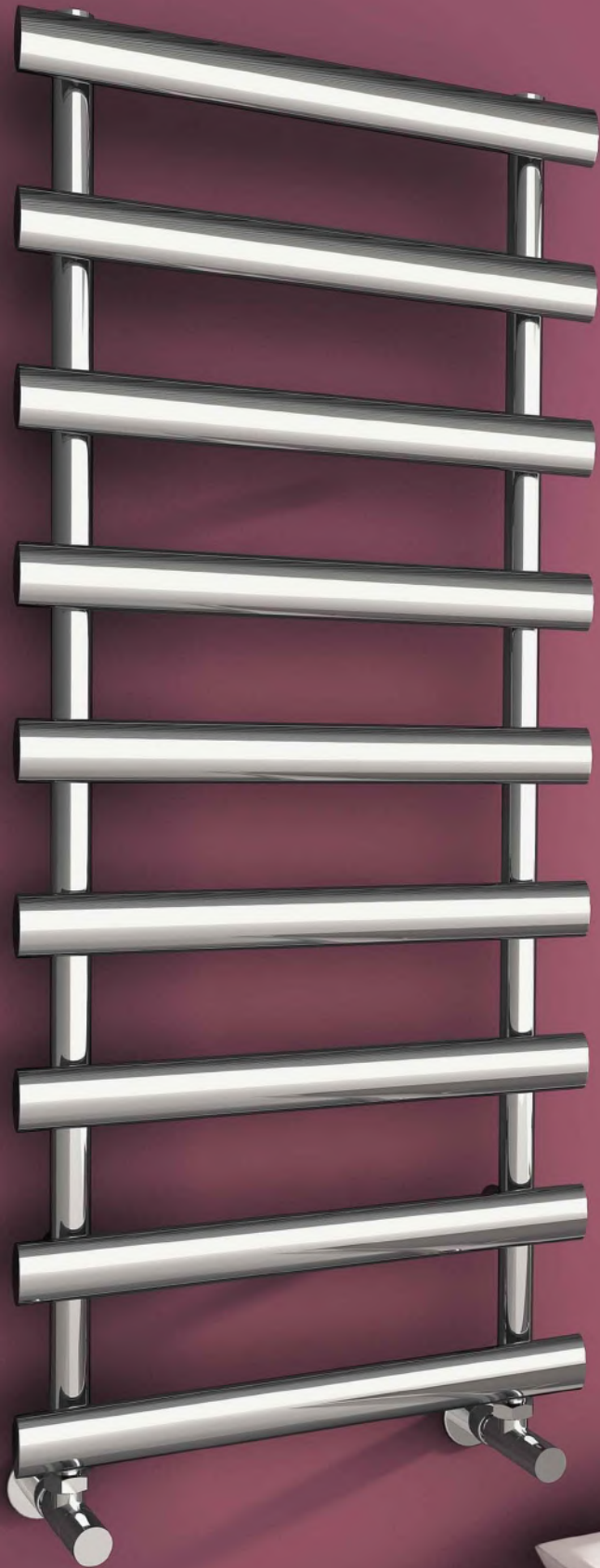

146



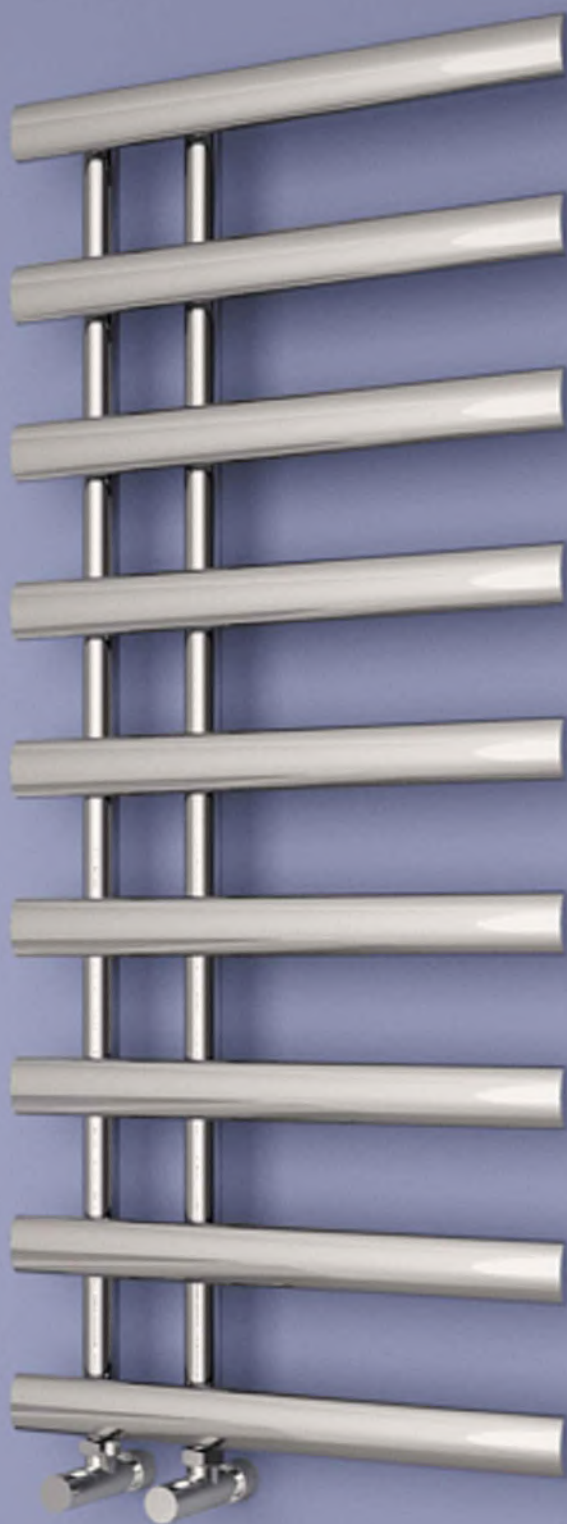

NERO

# VALENCIA



# VERONA

STEEL DESIGNER RADIATORS

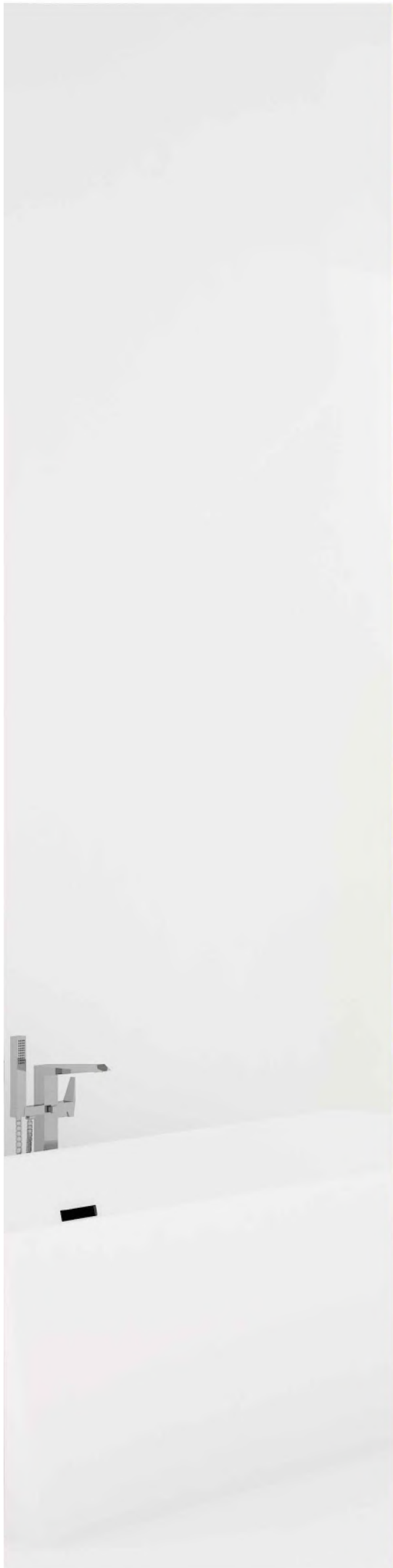
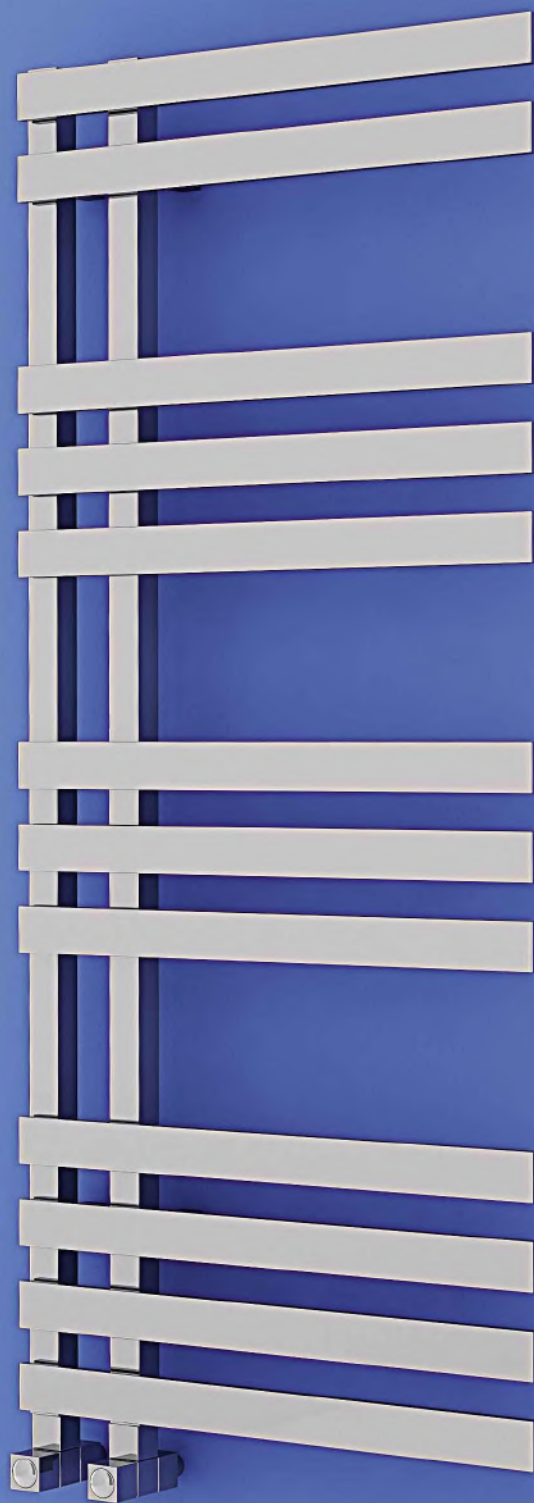

# ETAGE



# VICTORIA

STEEL TRADITIONAL RADIATORS



148

# VINTAGE



148

# EDWARD

STEEL TRADITIONAL RADIATORS



87

# BARKOD







841

MAYRA





New

DORA



149

1968

1972



NILE

STEEL DESIGNER RADIATORS

641

# BESPOKES

The bespoke products which are not in our stocks for now. You can still order these products, they will be available in 4-6 weeks with pre-order option.



UNIQUE

TRIA



SQUA

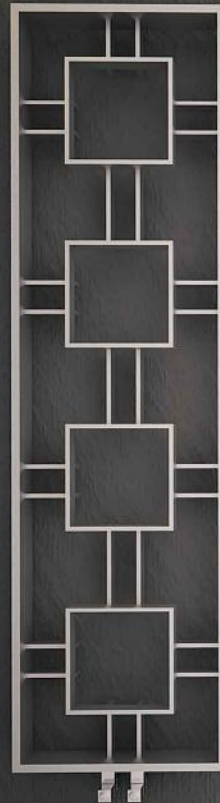



PIANO



ABAKO

STAINLESS STEEL DESIGNER RADIATORS  
4-6 weeks



APRIL



ARCO

# BESPOKES



ZIGZAG



PIAZZE



WOODSTOCK

GRACE





4 weeks



CLASICO



PAN



UNA



DOMINO

391

# BESPOKES



CLASH

FLAP



BECK



RUMA



155 4-6 weeks 99

# BESPOKES



ORIS

FORTE



VERSAILLES



FUTURA





KEOPS



HERMES

CALISTA



STAINLESS STEEL DESIGNER RADIATORS  
4-6 weeks

157

## STOCK COLOURS & FINISHES

All models are available in all the listed colours and finishes, please see the individual product key.  
for aluminium models only

<b>W</b>	RAL 9016 TRAFFIC WHITE
<b>TXW</b>	RAL 9016 TEXTURED WHITE
<b>TXB</b>	RAL 9005 TEXTURED BLACK
<b>TXG</b>	TEXTURED METALLIC DARK GREY
<b>MAT</b>	MATT ANODIZED
<b>PLS</b>	POLISHED ANODIZED
<b>TXL</b>	TEXTURED LATTE (BESPOKE)

for stainless steel models only

<b>STP</b>	SATIN POLISHED
<b>MRP</b>	MIRROR POLISHED

for steel and traditional models only

<b>CHR</b>	CHROME PLATED
<b>W</b>	RAL 9016 TRAFFIC WHITE
<b>TXA</b>	RAL 7016 TEXTURED ANTHRACITE
<b>MATC</b>	MATT COPPER
<b>TXLG</b>	TEXTURED LIGHT GREY

All of our Aluminium Radiators can be painted with these colours with an additional cost of %20 on the price. Bespoke colours will be available in 4-6 weeks delivery.

## KEY

Please refer to the features of each individual product to see which colour or finish is available.

## NOTE

All heat outputs shown are calculated in accordance with EN 442, 75/65-20 °C operating conditions, giving a  $\Delta T$  of 50 °C and shown in Watts.

To convert to  $\Delta T$  of 60 °C multiply output shown by 1.267

To convert Watts to BTU<sub>s</sub> multiply heat output shown by 3.412

## OUR PRODUCT RANGE

All our radiators are produced and outputs measured in accordance with European standard EN 442. When commissioning the radiator on an indirect/closed system we recommend using a suitable mixed metal inhibitor in suitable quantities to protect against scale and corrosion.

## PRODUCT CODES NOTING

Please be careful when noting codes.

A single digit error may cause a wrong model to be ordered or delay the ordering and delivery process.

## SINGLE OR DOUBLE RADIATORS

Using Double models with same design maximises heat output within the same wall space.

Our Tallis, Nemo and Monza models comes in single or double versions.

## HORIZONTAL & VERTICAL MODELS

Most of our designs are available in horizontal or vertical options which means you can maximise the use of ceiling heights and long low spaces, without losing heat output.

Bespoke Products shown in the catalog ( made to order ) is available for most of our range with 4-6 weeks delivery time.

We recommend you choose radiators with a higher output than required, as you can always turn them off. You have the reassurance of additional heat in really cold periods.

## DELIVERIES

Delivery times are noted at the top of each individual product page.

Multiple items may extend this lead time on bespoke special orders.

We will confirm the expected delivery date on our order acknowledgment at the time of order.

Deliveries will be made to the nearest hard standing area.

Delivery is available to most mainland UK business addresses although some remote and rural areas including islands should note that delivery times may be extended or in some instances not available at all.

Additional delivery costs may also apply.



**MATERIAL**  
STAINLESS STEEL

**GUARANTEE**  
25 YEARS

**ADAGIO**  
LIMITED EDITION

middle connection (50 mm.) available only

connection centers **C1** 50 mm.

max. working pressure 10 bar

max. working temperature 95 °C

connections 1/2"

heating element usage included

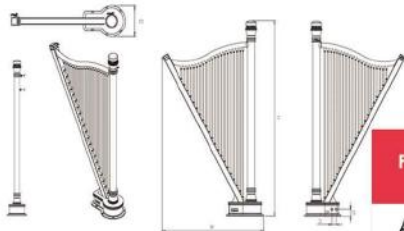

PRODUCT CODE	Height mm	Width mm	Heat outputs ΔT 50°C Watts Btu	PRICE (ex VAT)
ADA1150200021	2000	1150	2088 7174	£ 17990

## ALUMINIUM DESIGNER RADIATORS TECHNICAL SPECIFICATIONS

### QUADRO



**MATERIAL**  
ALUMINIUM

**STOCK FINISHES**  
TXW

**GUARANTEE**  
5 YEARS

**INSTALLATION**  
VERTICAL

1-2 DAYS  
DELIVERY

middle connection (50 mm.) available only

connection centers **C1** 50 mm.

max. working pressure 10 bar

max. working temperature 95 °C

connections 1/2"

A full range of made to order sizes available.

Please ask for details.

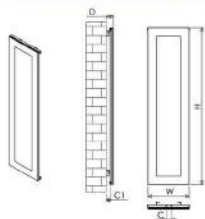

PRODUCT CODE	Height mm	Width mm	Sections	Pipe centers mm	Wall to pipe centers mm	Wall distance mm	Nett weight kg	Water content lt	Fuel type mm	Heat outputs ΔT 50°C Watts Btu	PRICE (ex VAT)
QUA 0280 1610 03	1610	280	3	50	30-50	64-84	10,4	0,9	C	707 2545	£ 713
QUA 0470 1800 05	1800	470	5	50	30-50	64-84	15,6	1,9	C	1326 4776	£ 860

### STEP MIRROR

**MATERIAL**  
ALUMINIUM

**STOCK FINISHES**  
PLS

**GUARANTEE**  
5 YEARS

**INSTALLATION**  
VERTICAL

1-2 DAYS  
DELIVERY

element width 90 mm.

max. working pressure 10 bar

element depth 70 mm.

max. working temperature 95 °C

radiator width for made to order sizes (n x95)- 5 mm.

connections 1/2"

n = number of elements

A full range of made to order sizes available.

connection centers **C1** W + 90 mm.

Please ask for details.

axis / wall distance **A** 30/50mm.

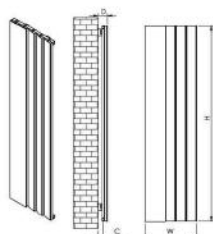

PRODUCT CODE	Height mm	Width mm	Sections	Pipe centers mm	Wall to pipe centers mm	Wall distance mm	Nett weight kg	Water content lt	Fuel type mm	Heat outputs ΔT 50°C Watts Btu	PRICE (ex VAT)
STM 0375 1800 04	1800	375	4	465	30-50	60-80	11,5	1,5	C	1334 4802	£ 749
STM 0470 1800 05	1800	470	5	560	30-50	60-80	13,5	1,9	C	1658 5967	£ 819

# KARO

MATERIAL  
ALUMINIUM

STOCK FINISHES  
TXW/TXB

GUARANTEE  
5 YEARS

INSTALLATION  
VERTICAL

1-2 DAYS  
DELIVERY

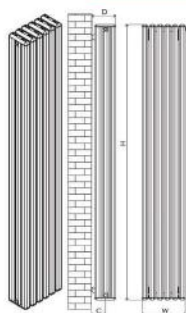

element width 40 mm.  
 element depth 140 mm.  
 radiator width for made to order sizes (n x 50)- 10 mm.  
 n = number of elements  
 connection centers C1 W + 90 mm.  
 axis / wall distance A 90 mm.

max. working pressure 10 bar  
 max. working temperature 95 °C  
 connections 1/2"  
 A full range of made to order sizes available.  
 Please ask for details.

PRODUCT CODE	Height mm	Width mm	Sections	Pipe centers mm	Wall to pipe centers mm	Wall distance mm	Nett weight kg	Water content lt	Fuel type mm	Heat outputs ΔT 50°C Watts Btu	PRICE (ex VAT)
KAR 0290 1800 06	1800	290	6	380	90	160	28,2	2,6	C	3298 11872	£ 982
KAR 0340 1800 07	1800	340	7	430	90	160	32,9	3	C	3848 13853	£ 1192
KAR 0390 1800 08	1800	390	8	480	90	160	37,6	3,4	C	4398 15833	£ 1335

# TUBO

MATERIAL  
ALUMINIUM

STOCK FINISHES  
TXW/TXB

GUARANTEE  
5 YEARS

INSTALLATION  
VERTICAL

1-2 DAYS  
DELIVERY

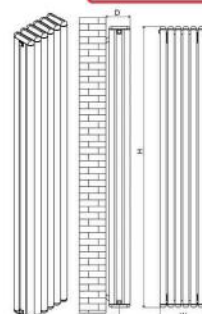

element width 40 mm.  
 element depth 140 mm.  
 radiator width for made to order sizes (n x 50)- 10 mm.  
 n = number of elements  
 connection centers C1 W + 90 mm.  
 axis / wall distance A 90 mm.

max. working pressure 10 bar  
 max. working temperature 95 °C  
 connections 1/2"  
 A full range of made to order sizes available.  
 Please ask for details.

PRODUCT CODE	Height mm	Width mm	Sections	Pipe centers mm	Wall to pipe centers mm	Wall distance mm	Nett weight kg	Water content lt	Fuel type mm	Heat outputs ΔT 50°C Watts Btu	PRICE (ex VAT)
TBO 0290 1800 06	1800	290	6	380	90	160	25,8	2,6	C	2898 10433	£ 923
TBO 0340 1800 07	1800	340	7	430	90	160	30	3	C	3381 12172	£ 1116
TBO 0390 1800 08	1800	390	8	480	90	160	34,4	3,4	C	3864 13910	£ 1259

# MOTION

MATERIAL  
ALUMINIUM

STOCK FINISHES  
TXA

GUARANTEE  
5 YEARS

INSTALLATION  
VERTICAL/HORIZONTAL

1-2 DAYS  
DELIVERY

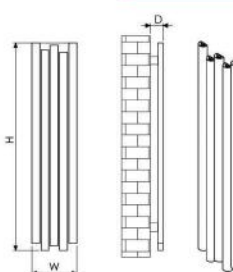

element width 70 mm.  
 element depth 70 mm.  
 radiator width for made to order sizes (n x 80)-10 mm.  
 n = number of elements  
 connection centers C1 W + 90 mm.  
 axis / wall distance A 30/50mm.

max. working pressure 10 bar  
 max. working temperature 95 °C  
 connections 1/2"  
 A full range of made to order sizes available.  
 Please ask for details.

PRODUCT CODE	Height mm	Width mm	Sections	Pipe centers mm	Wall to pipe centers mm	Wall distance mm	Nett weight kg	Water content lt	Fuel type mm	Heat outputs ΔT 50°C Watts Btu	PRICE (ex VAT)
MOT 0390 1800 05	1800	390	5	480	30-50	85-105	12,2	1,6	C	1353 4871	£ 436
MOT 0550 1800 07	1800	550	7	640	30-50	85-105	17,8	2,2	C	1894 6819	£ 514
MOT 0630 0600 08	600	630	8	720	30-50	85-105	6,5	0,9	C	722 2598	£ 438
MOT 0950 0600 12	600	950	12	1040	30-50	85-105	8,1	1,1	C	1082 3897	£ 624



# OTTO

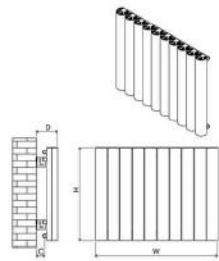

**MATERIAL**  
ALUMINIUM

**STOCK FINISHES**  
TXW/PLS

**GUARANTEE**  
5 YEARS

**INSTALLATION**  
VERTICAL / HORIZONTAL

**1-2 DAYS**  
**DELIVERY**

element width **75 mm.**  
 element depth **100 mm.**  
 radiator width for made to order sizes **(n x 80) - 5 mm.**

**n** = number of elements

connection centers **C1** **W + 90 mm.**  
 axis / wall distance **A** **30/50 mm.**

max. working pressure **10 bar**  
 max. working temperature **95 °C**  
 connections **1/2"**

A full range of made to order sizes available.  
 Please ask for details.

PRODUCT CODE	Height mm	Width mm	Sections	Pipe centers mm	Wall to pipe centers mm	Wall distance mm	Nett weight kg	Water content lt	Fuel type mm	Heat outputs ΔT 50°C Watts Btu	PRICE (ex VAT)
OTT0315 1800 04	1800	315	4	405	30-50	115-135	16,8	2,1	C	1748 6293	£ 649
OTT0395 1800 05	1800	395	5	485	30-50	115-135	21	2,6	C	2185 7866	£ 815
OTT0475 1800 06	1800	475	6	565	30-50	115-135	25,2	3,1	C	2622 9439	£ 969
OTT0795 0600 10	600	795	10	885	30-50	115-135	25,2	3,1	C	1691 6088	£ 692
OTT0955 0600 12	600	955	12	1045	30-50	115-135	30,2	3,8	C	2029 7304	£ 825

# GAIA

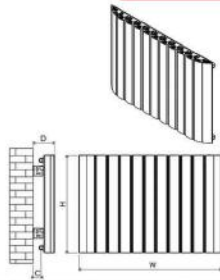

**MATERIAL**  
ALUMINIUM

**STOCK FINISHES**  
TXW

**GUARANTEE**  
5 YEARS

**INSTALLATION**  
VERTICAL / HORIZONTAL

**1-2 DAYS**  
**DELIVERY**

element width **70 + 100 mm.**  
 element depth **95 mm.**  
 radiator width for made to order sizes **((n-2) x 75) + 205 mm.**

**n** = number of elements

connection centers **C1** **W + 90 mm.**  
 axis / wall distance **A** **30/50mm.**

max. working pressure **10 bar**  
 max. working temperature **95 °C**  
 connections **1/2"**

A full range of made to order sizes available.  
 Please ask for details.

PRODUCT CODE	Height mm	Width mm	Sections	Pipe centers mm	Wall to pipe centers mm	Wall distance mm	Nett weight kg	Water content lt	Fuel type mm	Heat outputs ΔT 50°C Watts Btu	PRICE (ex VAT)
GAI0355 1800 04	1800	355	4	445	30-50	110-130	15,9	2,1	C	1806 6502	£ 671
GAI0430 1800 05	1800	430	5	520	30-50	110-130	19,8	2,6	C	2257 8125	£ 847
GAI0505 1800 06	1800	505	6	595	30-50	110-130	23,9	3,1	C	2709 9752	£ 1002
GAI0730 0600 09	600	730	9	820	30-50	110-130	12,9	1,8	C	1574 5666	£ 681
GAI0880 0600 11	600	880	11	970	30-50	110-130	15,8	2,2	C	1924 6926	£ 825
GAI1030 0600 13	600	1030	13	1120	30-50	110-130	18,7	2,6	C	2274 8186	£ 958

# VESTA

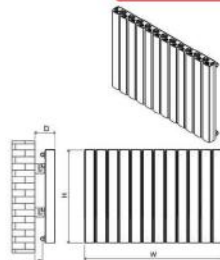

**MATERIAL**  
ALUMINIUM

**STOCK FINISHES**  
TXW/TXG/PLS

**GUARANTEE**  
5 YEARS

**INSTALLATION**  
VERTICAL / HORIZONTAL

**1-2 DAYS**  
**DELIVERY**

element width **70 mm.**  
 element depth **95 mm.**  
 radiator width for made to order sizes **(n x 75) - 5 mm.**

**n** = number of elements

connection centers **C1** **W + 90 mm.**  
 axis / wall distance **A** **30/50mm.**

max. working pressure **10 bar**  
 max. working temperature **95 °C**  
 connections **1/2"**

A full range of made to order sizes available.  
 Please ask for details.

PRODUCT CODE	Height mm	Width mm	Sections	Pipe centers mm	Wall to pipe centers mm	Wall distance mm	Nett weight kg	Water content lt	Fuel type mm	Heat outputs ΔT 50°C Watts Btu	PRICE (ex VAT)
VES0295 1800 04	1800	295	4	385	30-50	110-130	15,8	2,1	C	1764 6350	£ 605
VES0370 1800 05	1800	370	5	460	30-50	110-130	19,7	2,6	C	2205 7938	£ 771
VES0445 1800 06	1800	445	6	535	30-50	110-130	23,7	3,1	C	2646 9526	£ 912
VES0745 0600 10	600	745	10	835	30-50	110-130	14,2	2	C	1709 6152	£ 637
VES0895 0600 12	600	895	12	985	30-50	110-130	17	2,4	C	2051 7384	£ 770
VES1045 0600 14	600	1045	14	1135	30-50	110-130	20	2,8	C	2392 8611	£ 891

# ELVINO

MATERIAL  
**ALUMINIUM**

STOCK FINISHES  
TXW/TXB/TXG/PLS

GUARANTEE  
**5 YEARS**

INSTALLATION  
VERTICAL/HORIZONTAL

1-2 DAYS  
DELIVERY

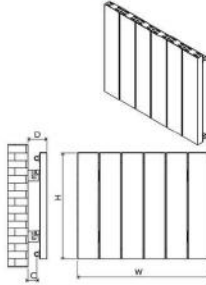

element width **120 mm.** max. working pressure **10 bar**  
 element depth **70 mm.** max. working temperature **95 °C**  
 radiator width for made to order sizes **(n x125)- 5 mm.** connections **1/2"**  
 $n$  = number of elements  
 A full range of made to order sizes available.  
 connection centers **C | W + 90 mm.** Please ask for details.  
 axis / wall distance **A 30/50mm.**

PRODUCT CODE	Height mm	Width mm	Sections	Pipe centers mm	Wall to pipe centers mm	Wall distance mm	Nett weight kg	Water content lt	Fuel type mm	Heat outputs $\Delta T$ 50°C Watts Btu	PRICE (ex VAT)
ELV 0370 1800 03	1800	370	3	460	25-45	85-105	15	1,6	C	1042 3751	£ 471
ELV 0495 1800 04	1800	495	4	585	25-45	85-105	20	2,2	C	1389 5000	£ 618
ELV 0745 0600 06	600	745	6	835	25-45	85-105	11,1	1,4	C	807 2905	£ 492
ELV 0995 0600 08	600	995	8	1085	25-45	85-105	14,8	1,8	C	1076 3874	£ 650
ELV 1245 0600 10	600	1245	10	1335	25-45	85-105	18,5	2,3	C	1345 4842	£ 828

# WAVE

MATERIAL  
**ALUMINIUM**

STOCK FINISHES  
PLS

GUARANTEE  
**5 YEARS**

INSTALLATION  
VERTICAL/HORIZONTAL

1-2 DAYS  
DELIVERY

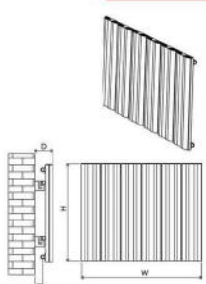

element width **120 mm.** max. working pressure **10 bar**  
 element depth **70 mm.** max. working temperature **95 °C**  
 radiator width for made to order sizes **(n x125)- 5 mm.** connections **1/2"**  
 $n$  = number of elements  
 A full range of made to order sizes available.  
 connection centers **C | W + 90 mm.** Please ask for details.  
 axis / wall distance **A 30/50mm.**

PRODUCT CODE	Height mm	Width mm	Sections	Pipe centers mm	Wall to pipe centers mm	Wall distance mm	Nett weight kg	Water content lt	Fuel type mm	Heat outputs $\Delta T$ 50°C Watts Btu	PRICE (ex VAT)
WAV 0370 1800 03	1800	370	3	460	30-50	85-105	12	1,65	C	1250 4500	£ 461
WAV 0495 1800 04	1800	495	4	585	30-50	85-105	16	2,2	C	1667 6001	£ 608
WAV 0745 0600 06	600	745	6	835	30-50	85-105	9,2	1,4	C	968 3485	£ 482
WAV 0995 0600 08	600	995	8	1085	30-50	85-105	12,2	1,8	C	1292 4651	£ 639
WAV 1245 0600 10	600	1245	10	1335	30-50	85-105	15,3	2,3	C	1614 5810	£ 818

# NIXIE

MATERIAL  
**ALUMINIUM**

STOCK FINISHES  
TXW/TXB

GUARANTEE  
**5 YEARS**

INSTALLATION  
VERTICAL/HORIZONTAL

1-2 DAYS  
DELIVERY

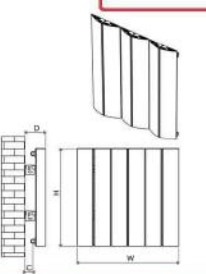

element width **100 mm.** max. working pressure **10 bar**  
 element depth **90 mm.** max. working temperature **95 °C**  
 radiator width for made to order sizes **(n x105)- 5 mm.** connections **1/2"**  
 $n$  = number of elements  
 A full range of made to order sizes available.  
 connection centers **C | W + 90 mm.** Please ask for details.  
 axis / wall distance **A 30/50mm.**

PRODUCT CODE	Height mm	Width mm	Sections	Pipe centers mm	Wall to pipe centers mm	Wall distance mm	Nett weight kg	Water content lt	Fuel type mm	Heat outputs $\Delta T$ 50°C Watts Btu	PRICE (ex VAT)
NIX 0205 1800 02	1800	205	2	295	30-50	105-125	8,8	1,1	C	1067 3841	£ 335
NIX 0415 1800 04	1800	415	4	505	30-50	105-125	16,76	2,2	C	2134 7682	£ 650
NIX 0625 0600 06	600	625	6	715	30-50	105-125	7,5	1,2	C	1304 4694	£ 419
NIX 0835 0600 08	600	835	8	925	30-50	105-125	10	1,6	C	1738 6257	£ 555
NIX 1045 0600 10	600	1045	10	1135	30-50	105-125	12,5	2	C	2174 7826	£ 702
NIX 1255 0600 12	600	1255	12	1345	30-50	105-125	15	2,4	C	2608 9489	£ 839

# NEMO DOUBLE

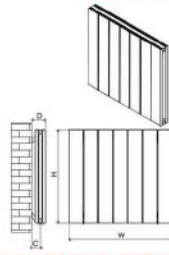

**MATERIAL**  
ALUMINIUM

**STOCK FINISHES**  
TXW/TXB/TXL

**GUARANTEE**  
5 YEARS

**INSTALLATION**  
VERTICAL/HORIZONTAL

**1-2 DAYS**  
**DELIVERY!**

element width **90 mm.**  
 element depth **70 mm.**  
 radiator width for made to order sizes **(n x 95) - 5 mm.**  
 n = number of elements  
 connection centers **C 1** **W + 90 mm.**  
 axis / wall distance **A** **55 mm.**

max. working pressure **10 bar**  
 max. working temperature **95 °C**  
 connections **1/2"**  
 A full range of made to order sizes available.  
 Please ask for details.

PRODUCT CODE	Height mm	Width mm	Sections	Pipe centers mm	Wall to pipe centers mm	Wall distance mm	Nett weight kg	Water content lt	Fuel type mm	Heat outputs ΔT 50°C Watts Btu	PRICE (ex VAT)
NMD 0280 1800 03	1800	280	3	370	55	90	11	1,2	C	1128 4061	£ 482
NMD 0375 1800 04	1800	375	4	465	55	90	14,4	1,6	C	1504 5414	£ 608
NMD 0470 1800 05	1800	470	5	560	55	90	18	1,9	C	1880 6768	£ 723
NMD 0470 0600 05	600	470	5	560	55	90	6,8	0,8	C	644 2318	£ 356
NMD 0660 0600 07	600	660	7	750	55	90	9,5	1,1	C	902 3246	£ 482
NMD 0850 0600 09	600	850	9	940	55	90	12	1,4	C	1159 4173	£ 587
NMD 1040 0600 11	600	1040	11	1130	55	90	14,9	1,8	C	1417 5100	£ 713
NMD 1230 0600 13	600	1230	13	1320	55	90	18	2,1	C	1674 6028	£ 818

# NEMO



**MATERIAL**  
ALUMINIUM

**STOCK FINISHES**  
TXW/TXB/TXL

**GUARANTEE**  
5 YEARS

**INSTALLATION**  
VERTICAL/HORIZONTAL

**1-2 DAYS**  
**DELIVERY!**

element width **90 mm.**  
 element depth **46 mm.**  
 radiator width for made to order sizes **(n x 95) - 5 mm.**  
 connection centers **C 1** **W + 90 mm.**  
 axis / wall distance **A** **30/50 mm.**

max. working pressure **10 bar**  
 max. working temperature **95 °C**  
 connections **1/2"**

PRODUCT CODE	Height mm	Width mm	Sections	Pipe centers mm	Wall to pipe centers mm	Wall distance mm	Nett weight kg	Water content lt	Fuel type mm	Heat outputs ΔT 50°C Watts Btu	PRICE (ex VAT)
NMO 0280 1800 03	1800	280	3	370	30-50	60-80	6,9	1,5	C	789 2840	£ 274
NMO 0375 1800 04	1800	375	4	465	30-50	60-80	9,2	2	C	1052 3787	£ 373
NMO 0470 1800 05	1800	470	5	560	30-50	60-80	11,5	2,5	C	1315 4733	£ 450
NMO 0470 0600 05	600	470	5	560	30-50	60-80	4,5	0,8	C	533 1919	£ 230
NMO 0660 0600 07	600	660	7	750	30-50	60-80	6,3	1,1	C	746 2686	£ 307
NMO 0850 0600 09	600	850	9	940	30-50	60-80	8,1	1,4	C	959 3454	£ 395
NMO 1040 0600 11	600	1040	11	1130	30-50	60-80	9,9	1,7	C	1173 4222	£ 494
NMO 1230 0600 13	600	1230	13	1320	30-50	60-80	11,8	2,1	C	1386 4989	£ 571

# MONZA DOUBLE

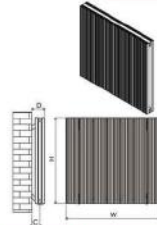

**MATERIAL**  
ALUMINIUM

**STOCK FINISHES**  
TXW/TXB/PLS/TXL

**GUARANTEE**  
5 YEARS

**INSTALLATION**  
VERTICAL/HORIZONTAL

**1-2 DAYS**  
**DELIVERY!**

element width **90 mm.**  
 element depth **70 mm.**  
 radiator width for made to order sizes **(n x 95) - 5 mm.**  
 n = number of elements  
 connection centers **C 1** **W + 90 mm.**  
 axis / wall distance **A** **55 mm.**

max. working pressure **10 bar**  
 max. working temperature **95 °C**  
 connections **1/2"**  
 A full range of made to order sizes available.  
 Please ask for details.

PRODUCT CODE	Height mm	Width mm	Sections	Pipe centers mm	Wall to pipe centers mm	Wall distance mm	Nett weight kg	Water content lt	Fuel type mm	Heat outputs ΔT 50°C Watts Btu	PRICE (ex VAT)
MND 0280 1800 03	1800	280	3	370	55	90	10,8	1,1	C	1128 4061	£ 482
MND 0375 1800 04	1800	375	4	465	55	90	14,4	1,5	C	1504 5415	£ 608
MND 0470 1800 05	1800	470	5	560	55	90	18	1,9	C	1880 6769	£ 723
MND 0470 0600 05	600	470	5	560	55	90	6,7	0,8	C	644 2318	£ 356
MND 0660 0600 07	600	660	7	750	55	90	9,4	1,1	C	902 3246	£ 482
MND 0850 0600 09	600	850	9	940	55	90	12,1	1,4	C	1159 4173	£ 587
MND 1040 0600 11	600	1040	11	1130	55	90	14,8	1,7	C	1417 5100	£ 713
MND 1230 0600 13	600	1230	13	1320	55	90	17,5	2,1	C	1674 6028	£ 818

# MONZA

MATERIAL  
**ALUMINIUM**

STOCK FINISHES  
**TXW/TXB/PLS**

GUARANTEE  
**5 YEARS**

INSTALLATION  
VERTICAL/HORIZONTAL

**1-2 DAYS**  
**DELIVERY**

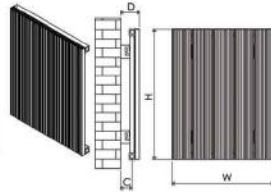

element width **90 mm.**  
 element depth **46 mm.**  
 radiator width for made to order sizes **(n x 95) - 5 mm.**  
 connection centers **C 1**  
 axis / wall distance **A**

max. working pressure **10 bar**  
 max. working temperature **95 °C**  
 connections **1/2"**  
 A full range of made to order sizes available.  
 Please ask for details.

PRODUCT CODE	Height mm	Width mm	Sections	Pipe centers mm	Wall to pipe centers mm	D Wall distance mm	Nett weight kg	Water content lt	Fuel type mm	Heat outputs ΔT 50°C Watts Btu	PRICE (ex VAT)
MNZ 0280 1800 03	1800	280	3	370	30-50	60-80	6,9	1,1	C	899 3238	£ 351
MNZ 0375 1800 04	1800	375	4	465	30-50	60-80	9,2	1,5	C	1199 4317	£ 428
MNZ 0470 1800 05	1800	470	5	560	30-50	60-80	11,5	1,9	C	1499 5396	£ 516
MNZ 0470 0600 05	600	470	5	560	30-50	60-80	4,6	0,8	C	608 2188	£ 252
MNZ 0660 0600 07	600	660	7	750	30-50	60-80	6,4	1,1	C	851 3063	£ 329
MNZ 0850 0600 09	600	850	9	940	30-50	60-80	8,3	1,4	C	1094 3938	£ 417
MNZ 1040 0600 11	600	1040	11	1130	30-50	60-80	10,1	1,8	C	1337 4813	£ 494
MNZ 1230 0600 13	600	1230	13	1320	30-50	60-80	11,9	2,8	C	1580 5688	£ 581

# ELLIPTIC

MATERIAL  
**ALUMINIUM**

STOCK FINISHES  
**TXW**

GUARANTEE  
**5 YEARS**

INSTALLATION  
VERTICAL/HORIZONTAL

**1-2 DAYS**  
**DELIVERY**

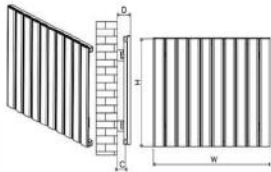

element width **75 mm.**  
 element depth **45 mm.**  
 radiator width for made to order sizes **(n x 80) - 5 mm.**  
 $\Pi$  = number of elements  
 connection centers **C 1**  
 axis / wall distance **A**

max. working pressure **10 bar**  
 max. working temperature **95 °C**  
 connections **1/2"**  
 A full range of made to order sizes available.  
 Please ask for details.

PRODUCT CODE	Height mm	Width mm	Sections	Pipe centers mm	Wall to pipe centers mm	D Wall distance mm	Nett weight kg	Water content lt	Fuel type mm	Heat outputs ΔT 50°C Watts Btu	PRICE (ex VAT)
ELL 0315 1800 04	1800	315	4	405	30-50	65-85	8,3	1,5	C	883 3180	£ 356
ELL 0395 1800 05	1800	395	5	485	30-50	65-85	10,3	1,9	C	1104 3974	£ 450
ELL 0475 1800 06	1800	475	6	565	30-50	65-85	12,4	2,2	C	1325 4769	£ 534
ELL 0795 0600 10	600	795	10	885	30-50	65-85	9,7	1,5	C	897 3229	£ 387
ELL 0955 0600 12	600	955	12	1045	30-50	65-85	11,6	1,8	C	1076 3875	£ 461
ELL 1195 0600 15	600	1195	15	1285	30-50	65-85	14,5	2,3	C	1346 4844	£ 566

# PLAY

MATERIAL  
**ALUMINIUM**

STOCK FINISHES  
**MAT / TXG**

GUARANTEE  
**5 YEARS**

INSTALLATION  
VERTICAL/HORIZONTAL

**1-2 DAYS**  
**DELIVERY**

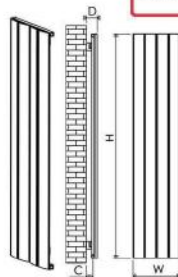

element width **90 mm.**  
 element depth **46 mm.**  
 radiator width for made to order sizes **(n x 95) - 5 mm.**  
 $\Pi$  = number of elements  
 connection centers **C 1**  
 axis / wall distance **A**

max. working pressure **10 bar**  
 max. working temperature **95 °C**  
 connections **1/2"**  
 A full range of made to order sizes available.  
 Please ask for details.

PRODUCT CODE	Height mm	Width mm	Sections	Pipe centers mm	Wall to pipe centers mm	D Wall distance mm	Nett weight kg	Water content lt	Fuel type mm	Heat outputs ΔT 50°C Watts Btu	PRICE (ex VAT)
PLY 0185 1800 02	1800	185	2	275	30-50	60-80	4	0,8	C	511 1838	£ 241
PLY 0375 1800 04	1800	375	4	465	30-50	60-80	8	1,5	C	1021 3676	£ 392
PLY 0565 0600 06	600	565	6	655	30-50	60-80	5	1	C	621 2236	£ 260
PLY 0755 0600 08	600	755	8	845	30-50	60-80	6,37	1,4	C	828 2981	£ 345
PLY 0945 0600 10	600	945	10	1035	30-50	60-80	8,3	1,8	C	1035 3726	£ 433

# STEP

**MATERIAL**  
ALUMINIUM

**STOCK FINISHES**  
TXW / TXG

**GUARANTEE**  
5 YEARS

**INSTALLATION**  
VERTICAL/HORIZONTAL

**1-2 DAYS**  
**DELIVERY**

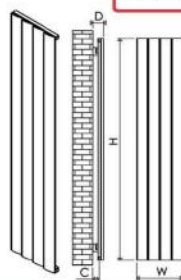

element width **90 mm.** max. working pressure **10 bar**  
 element depth **46 mm.** max. working temperature **95 °C**  
 radiator width for made to order sizes **(n x 95)- 5 mm.** connections **1/2"**  
 $n$  = number of elements  
 connection centers (horizontal) **C1** **W + 90 mm.** A full range of made to order sizes available.  
 axis / wall distance **A** **30/50 mm.** Please ask for details.

PRODUCT CODE	Height mm	Width mm	Sections	Pipe centers mm	Wall to pipe centers mm	D Wall distance mm	Nett weight kg	Water content lt	Fuel type mm	Heat outputs ΔT 50°C Watts Btu	PRICE (ex VAT)
STP 0280 1800 03	1800	280	3	370	30-50	60-80	6,1	1,1	C	766 2757	£ 276
STP 0375 1800 04	1800	375	4	465	30-50	60-80	8,1	1,5	C	1021 3676	£ 369
STP 0470 1800 05	1800	470	5	560	30-50	60-80	10,1	1,9	C	1277 4595	£ 450
STP 0470 0600 05	600	470	5	560	30-50	60-80	4,5	0,8	C	516 1863	£ 230
STP 0660 0600 07	600	660	7	750	30-50	60-80	6,3	1,1	C	725 2608	£ 307
STP 0850 0600 09	600	850	9	940	30-50	60-80	8,1	1,4	C	932 3353	£ 395
STP 1040 0600 11	600	1040	11	1130	30-50	60-80	9,9	1,7	C	1139 4099	£ 494
STP 1230 0600 13	600	1230	13	1320	30-50	60-80	11,8	2,1	C	1346 4844	£ 564

# ELITE

**MATERIAL**  
ALUMINIUM

**STOCK FINISHES**  
W

**GUARANTEE**  
5 YEARS

**INSTALLATION**  
VERTICAL/HORIZONTAL

**1-2 DAYS**  
**DELIVERY**

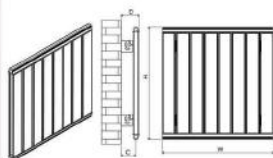

element width **70 mm.** max. working pressure **10 bar**  
 element depth **35 mm.** max. working temperature **95 °C**  
 radiator width for made to order sizes **(n x 75)- 5 mm.** connections **1/2"**  
 $n$  = number of elements  
 connection centers **C1** **W + 90 mm.** A full range of made to order sizes available.  
 axis / wall distance **A** **55/75 mm.** Please ask for details.

PRODUCT CODE	Height mm	Width mm	Sections	Pipe centers mm	Wall to pipe centers mm	D Wall distance mm	Nett weight kg	Water content lt	Fuel type mm	Heat outputs ΔT 50°C Watts Btu	PRICE (ex VAT)
ELT 0295 1800 04	1800	295	4	385	60-80	80-100	8,5	1,5	C	860 3097	£ 197
ELT 0370 1800 05	1800	370	5	460	60-80	80-100	10,8	1,9	C	1075 3871	£ 241
ELT 0445 1800 06	1800	445	6	535	60-80	80-100	13	2,2	C	1290 4645	£ 296
ELT 0595 0600 08	600	595	8	685	60-80	80-100	6,7	1,2	C	662 2385	£ 208
ELT 0745 0600 10	600	745	10	835	60-80	80-100	8,4	1,5	C	828 2981	£ 252
ELT 0895 0600 12	600	895	12	985	60-80	80-100	10	1,8	C	994 3577	£ 296
ELT 1045 0600 14	600	1045	14	1135	60-80	80-100	11,7	2,1	C	1159 4173	£ 351
ELT 1195 0600 16	600	1195	16	1285	60-80	80-100	13,5	2,4	C	1325 4769	£ 406

# TALLIS

**MATERIAL**  
ALUMINIUM

**STOCK FINISHES**  
TXW/TXB/PLS

**GUARANTEE**  
5 YEARS

**INSTALLATION**  
VERTICAL/HORIZONTAL

**1-2 DAYS**  
**DELIVERY**

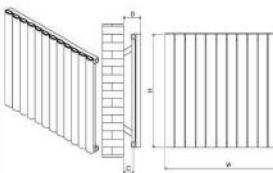

element width **50 mm.** max. working pressure **10 bar**  
 element depth **53 mm.** max. working temperature **95 °C**  
 radiator width for made to order sizes **(n x 60)- 10 mm.** connections **1/2"**  
 $n$  = number of elements  
 connection centers **C1** **W + 90 mm.** A full range of made to order sizes available.  
 axis / wall distance **A** **60 mm.** Please ask for details.

PRODUCT CODE	Height mm	Width mm	Sections	Pipe centers mm	Wall to pipe centers mm	D Wall distance mm	Nett weight kg	Water content lt	Fuel type mm	Heat outputs ΔT 50°C Watts Btu	PRICE (ex VAT)
TLL 0350 1800 06	1800	350	6	440	55	80	10,2	2,2	C	1007 3627	£ 303
TLL 0470 1800 08	1800	470	8	560	55	80	13,5	2,9	C	1343 4836	£ 398
TLL 0710 0600 12	600	710	12	800	55	80	7,6	1,8	C	1132 4074	£ 314
TLL 0950 0600 16	600	950	16	1040	55	80	10,1	2,4	C	1509 5432	£ 398
TLL 1190 0600 20	600	1190	20	1280	55	80	12,6	3	C	1886 6790	£ 482

# TALLIS DOUBLE

MATERIAL  
**ALUMINIUM**

STOCK FINISHES  
**TXW/TXB/PLS**

GUARANTEE  
**5 YEARS**

INSTALLATION  
VERTICAL/HORIZONTAL

**1-2 DAYS  
DELIVERY**

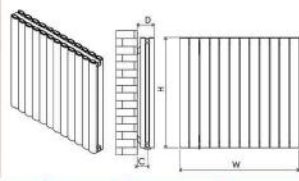

element width **50 mm.**  
 element depth **75 mm.**  
 radiator width for made to order sizes **(n x 60) - 10 mm.**  
 $n$  = number of elements  
 connection centers **C1**  
 axis / wall distance **A**

max. working pressure **10 bar**  
 max. working temperature **95 °C**  
 connections **1/2"**  
 A full range of made to order sizes available.  
 Please ask for details.

PRODUCT CODE	Height mm	Width mm	Sections	Pipe centers mm	Wall to pipe centers mm	D Wall distance mm	Nett weight kg	Water content lt	Fuel type mm	Heat outputs ΔT 50°C Watts Btu	PRICE (ex VAT)
TLD 0350 1800 06	1800	350	6	440	60	95	15,7	2,2	C	1366 4918	£ 398
TLD 0470 1800 08	1800	470	8	560	60	95	20,9	2,9	C	1822 6558	£ 524
TLD 0710 0600 12	600	710	12	800	60	95	11,3	1,8	C	1242 4471	£ 408
TLD 0950 0600 16	600	950	16	1040	60	95	13,4	2,4	C	1656 5962	£ 524
TLD 1190 0600 20	600	1190	20	1280	60	95	16,8	3	C	2070 7452	£ 629

# TALLIS XL & TALLIS XL DOUBLE

MATERIAL  
**ALUMINIUM**

STOCK FINISHES  
**TXW/TXB/PLS**

GUARANTEE  
**5 YEARS**

INSTALLATION  
VERTICAL/HORIZONTAL

**1-2 DAYS  
DELIVERY**



Horizontal Assembly brackets are included in the prices.

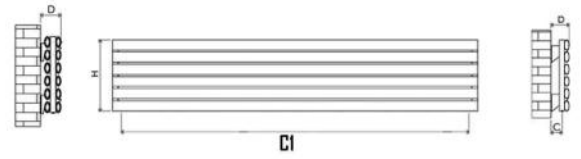

PRODUCT CODE	Height mm	Width mm	C1 Axis Horizontal mm	Wall to pipe centers mm	D Wall distance mm	Nett weight kg	Heat outputs Btu	PRICE (ex VAT)
TXL 1800 0350 06	350	1800	1775	60	100	10,2	3627	£ 345
TXL 1800 0470 08	470	1800	1775	60	100	13,5	4836	£ 440
TXD 1800 0350 06	350	1800	1775	55	93	15,7	4918	£ 440
TXD 1800 0470 08	470	1800	1775	55	93	20,9	6558	£ 566

# SOPHIA

MATERIAL  
**ALUMINIUM**

STOCK FINISHES  
**TXW/TXB**

GUARANTEE  
**5 YEARS**

INSTALLATION  
VERTICAL/HORIZONTAL

**1-2 DAYS  
DELIVERY**

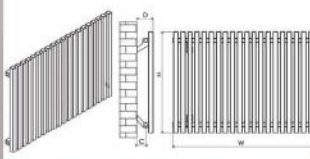

element width **50 mm.**  
 element depth **53 mm.**  
 radiator width for made to order sizes **(n x 42) - 5 mm.**  
 $n$  = number of elements  
 connection centers **C1**  
 axis / wall distance **A**

max. working pressure **10 bar**  
 max. working temperature **95 °C**  
 connections **1/2"**  
 A full range of made to order sizes available.  
 Please ask for details.

PRODUCT CODE	Height mm	Width mm	Sections	Pipe centers mm	Wall to pipe centers mm	D Wall distance mm	Nett weight kg	Water content lt	Fuel type mm	Heat outputs ΔT 50°C Watts Btu	PRICE (ex VAT)
SOP 0330 1800 08	1800	331	8	421	55	95	15,7	2,2	C	1049 3776	£ 429
SOP 0415 1800 10	1800	415	10	505	55	95	20,9	2,9	C	1311 4720	£ 524
SOP 0499 0600 12	600	499	12	589	55	95	11,3	1,8	C	635 2285	£ 324
SOP 0667 0600 16	600	667	16	757	55	95	13,4	2,4	C	846 3047	£ 440
SOP 0835 0600 20	600	835	20	925	55	95	16,8	3	C	1058 3809	£ 555

# SOPHIA XL

MATERIAL  
**ALUMINIUM**

STOCK FINISHES  
**TXW/TXB**

GUARANTEE  
**5 YEARS**

INSTALLATION  
VERTICAL/HORIZONTAL

**1-2 DAYS  
DELIVERY**



Horizontal Assembly brackets are included in the prices.

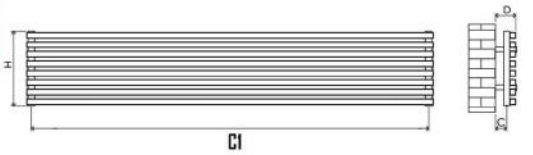

PRODUCT CODE	Height mm	Width mm	C1 Axis Horizontal mm	Wall to pipe centers mm	D Wall distance mm	Nett weight kg	Heat outputs Btu	PRICE (ex VAT)
SXL 1800 0330 08	330	1800	1740	55	95	15,7	3776	£ 471
SXL 1800 0415 10	415	1800	1740	55	95	20,9	4720	£ 566

# SOPHIA MIRROR & TALLIS MIRROR



MATERIAL  
**ALUMINIUM**

STOCK FINISHES  
**TXW/TXB**

GUARANTEE  
**5 YEARS**

INSTALLATION  
VERTICAL/HORIZONTAL

**1-2 DAYS  
DELIVERY**

STOCK FINISHES  
**TXW/TXB/PLS**

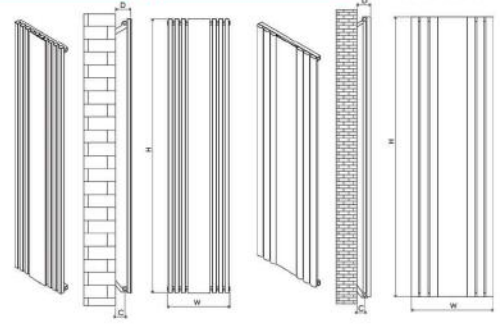

PRODUCT CODE	Height mm	Width mm	Sections	Pipe centers mm	Wall to pipe centers mm	Wall distance mm	Nett weight kg	Water content lt	Fuel type mm	Heat outputs $\Delta T$ 50°C Watts Btu	PRICE (ex VAT)
SOM 1800 0415 10	1800	415	10	505	55	95	23,5	2,9	C	1245 4484	£ 629
TAM 1800 0550 08	1800	550	8	640	55	95	21,5	3,9	C	1275 4591	£ 597

# ELVINO FLOOR

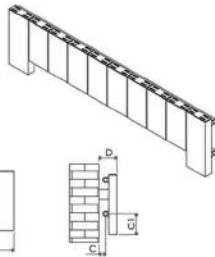

MATERIAL  
**ALUMINIUM**

STOCK FINISHES  
**TXW**

GUARANTEE  
**5 YEARS**

INSTALLATION  
**HORIZONTAL**

**1-2 DAYS  
DELIVERY**

element width **120 mm.**  
 element depth **70 mm.**  
 radiator width for made to order sizes **(n x125)- 5 mm.**  
 $n$  = number of elements  
 connection centers (horizontal) **C1 W + 90 mm.**  
 axis / wall distance **A 30/50 mm.**

max. working pressure **10 bar**  
 max. working temperature **95 °C**  
 connections **1/2"**  
 heating element usage available  
 A full range of made to order sizes available.  
 Please ask for details.

PRODUCT CODE	Height mm	Width mm	Sections	Pipe centers mm	Wall to pipe centers mm	Wall distance mm	Nett weight kg	Water content lt	Fuel type mm	Heat outputs $\Delta T$ 50°C Watts Btu	PRICE (ex VAT)
ELF 0995 0300 08	300	995	8	1085	30-50	87-107	5,5	0,85	C	460 1656	£ 408
ELF 1245 0300 10	300	1245	10	1335	30-50	87-107	7,1	1,1	C	575 2070	£ 503

# ELVINO BATH



MATERIAL  
**ALUMINIUM**

STOCK FINISHES  
**TXW / TXB**

GUARANTEE  
**5 YEARS**

INSTALLATION  
VERTICAL/HORIZONTAL

**1-2 DAYS  
DELIVERY**

connection centers **C1 W + 90 mm.**  
 axis / wall distance **A 30/50mm.**  
 max. working pressure **10 bar**  
 max. working temperature **95 °C**  
 connections **1/2"**

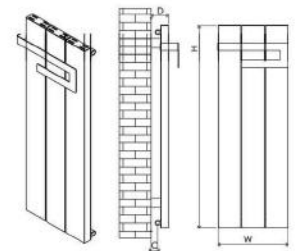

PRODUCT CODE	Height mm	Width mm	Sections	Pipe centers mm	Wall to pipe centers mm	Wall distance mm	Nett weight kg	Water content lt	Fuel type mm	Heat outputs $\Delta T$ 50°C Watts Btu	PRICE (ex VAT)
ELB 0370 0800 03	800	370	3	460	30-50	87-107	8,9	0,9	C	538 1938	£ 419

# NIXIE BATH



MATERIAL  
**ALUMINIUM**

STOCK FINISHES  
**TXW/TXB/PLS**

GUARANTEE  
**5 YEARS**

INSTALLATION  
**VERTICAL**

**1-2 DAYS  
DELIVERY!**

connection centers

axis / wall distance

max. working pressure

max. working temperature

connections

**C1**    **W + 90 mm.**  
**A**        **30/50mm.**  
  
**10 bar**  
**95 °C**  
**½"**

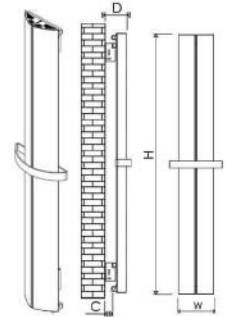

PRODUCT CODE	Height mm	Width mm	Sections	Pipe centers mm	Wall to pipe centers mm	Wall distance mm	Nett weight kg	Water content lt	Fuel type mm	Heat outputs ΔT 50°C Watts Btu	PRICE (ex VAT)
NXB 0205 1200 02	1200	205	2	295/50	30-50	115-135	9,5	0,6	C	449 1615	£ 335
NXB 0205 1500 02	1500	205	2	295/50	30-50	115-135	12,5	0,9	C	667 2402	£ 461
NXB 0205 1800 02	1800	205	2	295/50	30-50	115-135	13,3	1,1	C	800 2878	£ 545

# ELLIPTIC BATH



MATERIAL  
**ALUMINIUM**

STOCK FINISHES  
**PLS**

GUARANTEE  
**5 YEARS**

INSTALLATION  
**VERTICAL**

**1-2 DAYS  
DELIVERY!**

connection centers

axis / wall distance

max. working pressure

max. working temperature

connections

**C**        **W -25 mm.**  
**A**        **75mm.**  
  
**10 bar**  
**95 °C**  
**½"**

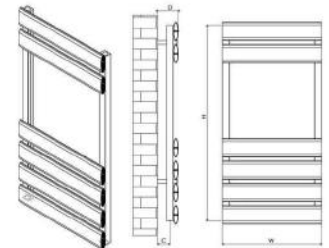

PRODUCT CODE	Height mm	Width mm	Sections	Pipe centers mm	Wall to pipe centers mm	Wall distance mm	Nett weight kg	Water content lt	Fuel type mm	Heat outputs ΔT 50°C Watts Btu	PRICE (ex VAT)
EPB 0500 0790 06	790	500	6	475	75	110	4,8	0,4	C	367 1326	£ 230
EPB 0500 1190 08	1190	500	8	475	75	110	6,7	0,5	C	496 1790	£ 282
EPB 0500 1590 10	1590	500	10	475	75	110	8,4	1,1	C	624 2254	£ 335

# FAME



MATERIAL  
**ALUMINIUM**

STOCK FINISHES  
**PLS**

GUARANTEE  
**5 YEARS**

INSTALLATION  
**VERTICAL**

**1-2 DAYS  
DELIVERY!**

connection centers

axis / wall distance

max. working pressure

max. working temperature

connections

**C1**        **W -25 mm.**  
**A**        **75 mm.**  
  
**10 bar**  
**95 °C**  
**½"**

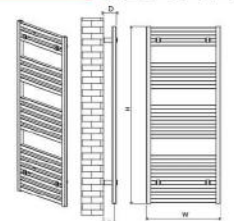

PRODUCT CODE	Height mm	Width mm	Sections	Pipe centers mm	Wall to pipe centers mm	Wall distance mm	Nett weight kg	Water content lt	Fuel type mm	Heat outputs ΔT 50°C Watts Btu	PRICE (ex VAT)
FME 0500 0700 10	700	500	10	475	75	90	4,3	1,3	C	470 1693	£ 230
FME 0500 1220 15	1220	500	15	475	75	90	7,1	1,9	C	706 2540	£ 282
FME 0500 1460 19	1460	500	19	475	75	90	8,7	2,4	C	894 3217	£ 377
FME 0500 1740 22	1740	500	22	475	75	90	10,2	2,9	C	1035 3725	£ 419

# FAME HORIZONTAL

MATERIAL  
**ALUMINIUM**

STOCK FINISHES  
**PLS**

GUARANTEE  
**5 YEARS**

INSTALLATION  
**VERTICAL**

**1-2 DAYS  
DELIVERY!**

PRODUCT CODE	Height mm	Width mm	Sections	Pipe centers mm	Wall to pipe centers mm	Wall distance mm	Nett weight kg	Water content lt	Fuel type mm	Heat outputs ΔT 50°C Watts Btu	PRICE (ex VAT)
FME 1000 0400 06	400	1000	6	975	75	90	5,1	1,6	C	559 2012	£ 335



# MATE

MATERIAL  
**ALUMINIUM**

STOCK FINISHES  
TXW/TXB

GUARANTEE  
**5 YEARS**

INSTALLATION  
VERTICAL

**1-2 DAYS**  
DELIVERY

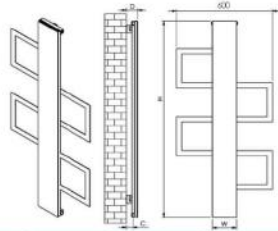

element width **90 mm.**  
 element depth **70 mm.**  
 radiator width for made to order sizes **(n x 95) - 5 mm.**  
 $n$  = number of elements  
 connection centers **C1** **W + 90 mm.**  
 axis / wall distance **A** **30/50mm.**  
 max. working pressure **10 bar**  
 max. working temperature **95 °C**  
 connections **1/2"**  
 A full range of made to order sizes available.  
 Please ask for details.

PRODUCT CODE	Height mm	Width mm	Sections	Pipe centers mm	Wall to pipe centers mm	Wall distance mm	Nett weight kg	Water content lt	Fuel type mm	Heat outputs ΔT 50°C Watts Btu	PRICE (ex VAT)
MAT 0600 0900 02	900	600	2	275	30-50	60-80	5,1	0,4	C	342 1419	£ 338
MAT 0600 1200 03	1200	600	3	275	30-50	60-80	6,7	0,6	C	458 1901	£ 462
MAT 0600 1500 04	1500	600	4	275	30-50	60-80	8,3	0,7	C	570 2366	£ 546

# BARON

MATERIAL  
**ALUMINIUM**

STOCK FINISHES  
PLS

GUARANTEE  
**5 YEARS**

INSTALLATION  
VERTICAL

**1-2 DAYS**  
DELIVERY



connection centers **C1** **W + 90 mm.**  
 axis / wall distance **A** **50 mm.**  
 max. working pressure **10 bar**  
 max. working temperature **95 °C**  
 connections **1/2"**

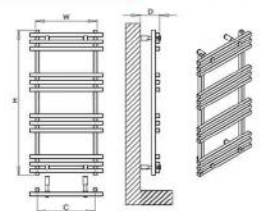

PRODUCT CODE	Height mm	Width mm	Sections	Pipe centers mm	Wall to pipe centers mm	Wall distance mm	Nett weight kg	Water content lt	Fuel type mm	Heat outputs ΔT 50°C Watts Btu	PRICE (ex VAT)
BRN 0500 0720 09	720	500	9	400	50	92	3,9	1,1	C	435 1565	£ 324
BRN 0500 1000 12	1000	500	12	400	50	92	5,2	0,9	C	580 2087	£ 398

# AJAX I - II

MATERIAL  
**ALUMINIUM**

STOCK FINISHES  
PLS

GUARANTEE  
**5 YEARS**

INSTALLATION  
VERTICAL

**1-2 DAYS**  
DELIVERY

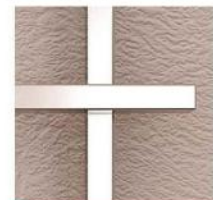

connection centers **C1** **W + 25 mm.**  
 axis / wall distance **A** **50 mm.**  
 max. working pressure **10 bar**  
 max. working temperature **95 °C**  
 connections **1/2"**

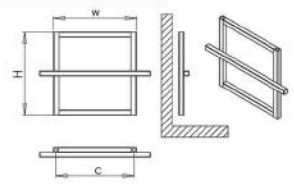

PRODUCT CODE	Height mm	Width mm	Sections	Pipe centers mm	Wall to pipe centers mm	Wall distance mm	Nett weight kg	Water content lt	Fuel type mm	Heat outputs ΔT 50°C Watts Btu	PRICE (ex VAT)
AJA 0600 0450 01	450	600	1	425	50	92	3,1	0,6	C	169 609	£ 156
AJA 0600 0450 02	450	600	2	425	50	92	3,5	0,7	C	225 811	£ 177

# SOHO

MATERIAL  
**ALUMINIUM**

STOCK FINISHES  
PLS

GUARANTEE  
**5 YEARS**

INSTALLATION  
VERTICAL

**1-2 DAYS**  
DELIVERY



connection centers **C** **W - 25 mm.**  
 axis / wall distance **A** **75mm.**  
 max. working pressure **10 bar**  
 max. working temperature **95 °C**  
 connections **1/2"**

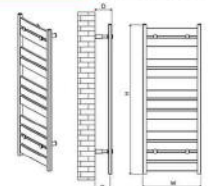

PRODUCT CODE	Height mm	Width mm	Sections	Pipe centers mm	Wall to pipe centers mm	Wall distance mm	Nett weight kg	Water content lt	Fuel type mm	Heat outputs ΔT 50°C Watts Btu	PRICE (ex VAT)
SOH 0500 0715 06	715	500	6	475	75	90	3,3	0,8	C	269 969	£ 209
SOH 0500 1225 11	1225	500	11	475	75	90	5,9	1,1	C	493 1776	£ 251
SOH 0500 1480 13	1480	500	13	475	75	90	7,3	1,4	C	583 2099	£ 303
SOH 0500 1735 15	1735	500	15	475	75	90	8,5	1,7	C	673 2422	£ 324

# ECLYPSIA



**MATERIAL**  
ALUMINIUM

**STOCK FINISHES**  
PLS

**GUARANTEE**  
5 YEARS

**INSTALLATION**  
VERTICAL

**1-2 DAYS**  
**DELIVERY**

connection centers **C**      **W -25 mm.**  
axis / wall distance **A**      **75mm.**  
max. working pressure **10 bar**  
max. working temperature **95 °C**  
connections **½"**

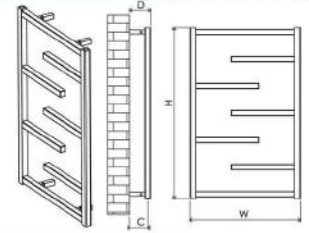

PRODUCT CODE	Height mm	Width mm	Sections	Pipe centers mm	Wall to pipe centers mm	Wall distance mm	Nett weight kg	Water content lt	Fuel type mm	Heat outputs ΔT 50°C Watts Btu	PRICE (ex VAT)
ECY 0500 0810 07	810	500	7	475	75	90	3,3	0,8	C	122 439	£ 303
ECY 0500 1100 09	1100	500	9	475	75	90	5,9	1,1	C	166 596	£ 366

# MONZA BATH



**MATERIAL**  
ALUMINIUM

**STOCK FINISHES**  
PLS

**GUARANTEE**  
5 YEARS

**INSTALLATION**  
VERTICAL

**1-2 DAYS**  
**DELIVERY**

connection centers **C**      **W -25 mm.**  
axis / wall distance **A**      **75 mm.**  
max. working pressure **10 bar**  
max. working temperature **95 °C**  
connections **½"**

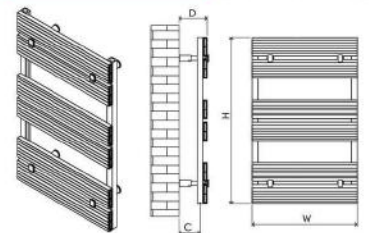

PRODUCT CODE	Height mm	Width mm	Sections	Pipe centers mm	Wall to pipe centers mm	Wall distance mm	Nett weight kg	Water content lt	Fuel type mm	Heat outputs ΔT 50°C Watts Btu	PRICE (ex VAT)
MZB 0500 0790 06	790	500	6	475	50	75	4,6	0,5	C	449 1614	£ 272
MZB 0500 1190 09	1190	500	9	475	50	75	6,4	0,7	C	598 2153	£ 314
MZB 0500 1590 12	1590	500	12	475	50	75	8,4	0,9	C	748 2691	£ 366

# ELVINO BATH MIRROR



**MATERIAL**  
ALUMINIUM

**STOCK FINISHES**  
MIRROR

**GUARANTEE**  
5 YEARS

**INSTALLATION**  
VERTICAL

**1-2 DAYS**  
**DELIVERY**

connection centers **C**      **W +90 mm.**  
axis / wall distance **A**      **75 mm.**  
max. working pressure **10 bar**  
max. working temperature **95 °C**  
connections **½"**

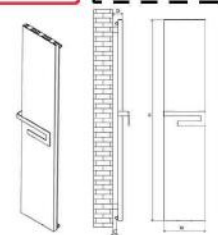

PRODUCT CODE	Height mm	Width mm	Sections	Pipe centers mm	Wall to pipe centers mm	Wall distance mm	Nett weight kg	Water content lt	Fuel type mm	Heat outputs ΔT 50°C Watts Btu	PRICE (ex VAT)
ELM 03701800 03	1800	370	3	460	30/50	130/150	18,3	1,65	C	1024 3685	£ 681

## STAINLESS STEEL DESIGNER RADIATORS TECHNICAL SPECIFICATIONS

# MISTRAL



**MATERIAL**  
STAINLESS STEEL

**STOCK FINISHES**  
BRUSHED

**GUARANTEE**  
20 YEARS

**INSTALLATION**  
HORIZONTAL

**1-2 DAYS**  
**DELIVERY**

max. working pressure **10 bar**      A full range of made to order sizes available.  
max. working temperature **95 °C**      Please ask for details.  
connections **½"**      element depth **90 mm.**  
element width **60 mm.**

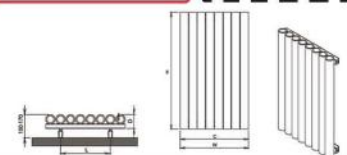

PRODUCT CODE	Height mm	Width mm	Sections	Pipe centers mm	Wall to pipe centers mm	Wall distance mm	Nett weight kg	Fuel type mm	Heat outputs ΔT 50°C Watts Btu	PRICE (ex VAT) BRUSHED
MIS 0320180005	1800	320	5	410	75 - 95	150-170	34,5	C/E/D	2354 8032	£ 1089
MIS 0385180006	1800	385	6	475	75 - 95	150-170	41,2	C/E/D	2641 9011	£ 1339
MIS 0450180007	1800	450	7	540	75 - 95	150-170	48,4	C/E/D	3301 11262	£ 1589

# FORTUNA



**MATERIAL**  
STAINLESS STEEL

**STOCK FINISHES**  
BRUSHED

**GUARANTEE**  
20 YEARS

**INSTALLATION**  
HORIZONTAL

**1-2 DAYS**  
**DELIVERY**

max. working pressure **10 bar** A full range of made to order sizes available.  
 max. working temperature **95 °C** Please ask for details.  
 connections **1/2"**  
 element width **60 mm.**  
 element depth **90 mm.**

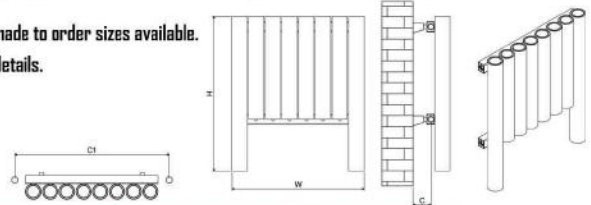

PRODUCT CODE	Height mm	Width mm	Sections	Pipe centers mm	Wall to pipe centers mm	Wall distance mm	Nett weight kg	Fuel type mm	Heat outputs ΔT 50°C Watts Btu	PRICE (ex VAT) BRUSHED
FOR 0515060008	600	515	8	605	75 - 95	150-170	23,5	C/E/D	1112 3795	£ 1389
FOR 0775060012	600	775	12	865	75 - 95	150-170	34,5	C/E/D	1626 5551	£ 2029
FOR 1035060016	600	1035	16	1125	75 - 95	150-170	46,5	C/E/D	3301 9367	£ 2649

# SARP



**MATERIAL**  
STAINLESS STEEL

**STOCK FINISHES**  
BRUSHED

**GUARANTEE**  
20 YEARS

**INSTALLATION**  
VERTICAL & HORIZONTAL

**1-2 DAYS**  
**DELIVERY**

element width **40 mm.** max. working pressure **10 bar**  
 element depth **40 mm.** max. working temperature **95 °C**  
 connection centers **C 1 W + 90 mm.** connections **1/2"**  
 axis / wall distance **A 75/95 mm.** heating element usage available

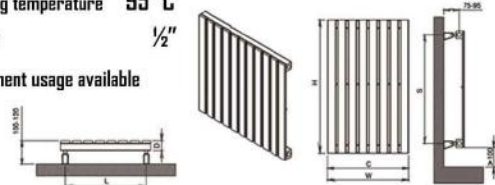

PRODUCT CODE	Height mm	Width mm	Sections	Pipe centers mm	Wall to pipe centers mm	Wall distance mm	Nett weight kg	Water content lt	Fuel type mm	Heat outputs ΔT 50°C Watts Btu	PRICE (ex VAT) BRUSHED
SRP 0590 0600 11	600	590	11	680	75-95	100-120	5,5	0,8	C/E/D	470 1602	£ 550
SRP 0810 0600 15	600	810	15	900	75-95	100-120	7,1	1,1	C/E/D	590 2012	£ 829
SRP 0260 1800 05	1800	260	5	350	75-95	100-120	5,5	0,8	C/E/D	618 2107	£ 499
SRP 0370 1800 07	1800	370	7	460	75-95	100-120	7,1	1,1	C/E/D	920 3137	£ 630

# STRIPE



**MATERIAL**  
STAINLESS STEEL

**STOCK FINISHES**  
BRUSHED

**GUARANTEE**  
20 YEARS

**INSTALLATION**  
VERTICAL & HORIZONTAL

**1-2 DAYS**  
**DELIVERY**

element width **40 / 10 mm.** max. working pressure **10 bar**  
 element depth **50 mm.** max. working temperature **95 °C**  
 connection centers **C 1 W + 90 mm.** connections **1/2"**  
 axis / wall distance **A 85/105 mm.** heating element usage available

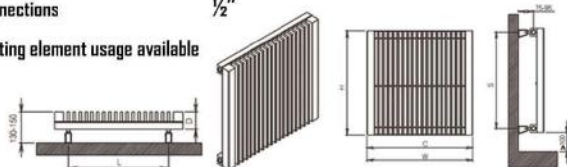

PRODUCT CODE	Height mm	Width mm	Sections	Pipe centers mm	Wall to pipe centers mm	Wall distance mm	Nett weight kg	Water content lt	Fuel type mm	Heat outputs ΔT 50°C Watts Btu	PRICE (ex VAT) BRUSHED
STR 0295 1800 10	1800	295	10	385	85-105	110-130	5,5	0,85	C/E/D	1161 3959	£ 679
STR 0395 1800 14	1800	395	14	485	85-105	110-130	7,1	1,1	C/E/D	1342 4576	£ 979
STR 0595 0600 22	600	595	22	685	85-105	110-130	5,5	0,85	C/E/D	550 1875	£ 529
STR 0795 0600 30	600	795	30	885	85-105	110-130	7,1	1,1	C/E/D	665 2270	£ 619

# HALO



**MATERIAL**  
STAINLESS STEEL

**STOCK FINISHES**  
BRUSHED/POLISHED

**GUARANTEE**  
20 YEARS

**INSTALLATION**  
VERTICAL

**1-2 DAYS**  
**DELIVERY**

max. working pressure 10 bar  
max. working temperature 95 °C  
all dimensions are in mm.  
connections ½"

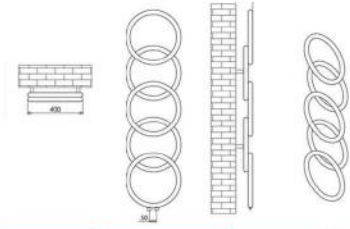

PRODUCT CODE	Height mm	Width mm	Sections	Pipe centers mm	Wall to pipe centers mm	Wall distance mm	Nett weight kg	Fuel type mm	Heat outputs ΔT 50°C Watts Btu	PRICE (ex VAT)	PRICE (ex VAT)
										BRUSHED	POLISHED
HAL 0400 0930 03	930	400	3	50	66-86	82-102	4,3	C	230 828	£ 869	£ 989
HAL 0400 1470 05	1470	400	5	50	66-86	82-102	8	C	400 1440	£ 1216	£ 1485

# VECTOR



**MATERIAL**  
STAINLESS STEEL

**STOCK FINISHES**  
BRUSHED/POLISHED

**GUARANTEE**  
20 YEARS

**INSTALLATION**  
VERTICAL

**1-2 DAYS**  
**DELIVERY**

max. working pressure 10 bar  
max. working temperature 95 °C  
all dimensions are in mm.  
connections ½"

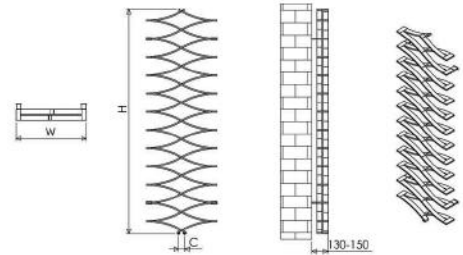

PRODUCT CODE	Height mm	Width mm	Sections	Pipe centers mm	Wall to pipe centers mm	Wall distance mm	Nett weight kg	Fuel type mm	Heat outputs ΔT 50°C Watts Btu	PRICE (ex VAT)	PRICE (ex VAT)
										BRUSHED	POLISHED
VEC 0500 1800 12	1800	500	12	50	70-100	140-170	21	C	890 3204	£ 2120	£ 2544

# CRUX



**MATERIAL**  
STAINLESS STEEL

**STOCK FINISHES**  
BRUSHED/POLISHED

**GUARANTEE**  
20 YEARS

**INSTALLATION**  
VERTICAL

**1-2 DAYS**  
**DELIVERY**

max. working pressure 10 bar  
max. working temperature 95 °C  
all dimensions are in mm.  
connections ½"

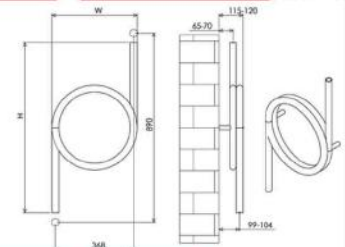

PRODUCT CODE	Height mm	Width mm	Sections	Pipe centers mm	Wall to pipe centers mm	Wall distance mm	Nett weight kg	Fuel type mm	Heat outputs ΔT 50°C Watts Btu	PRICE (ex VAT)	PRICE (ex VAT)
										BRUSHED	POLISHED
CRX 0400 0800 02	800	400	2	368	(65/99)	115-120	11,6	C	192 691	£ 479	£ 574

# BARO



**MATERIAL**  
STAINLESS STEEL

**STOCK FINISHES**  
BRUSHED/POLISHED

**GUARANTEE**  
20 YEARS

**INSTALLATION**  
VERTICAL

**1-2 DAYS**  
**DELIVERY**

max. working pressure 10 bar  
max. working temperature 95 °C  
all dimensions are in mm.  
connections ½"

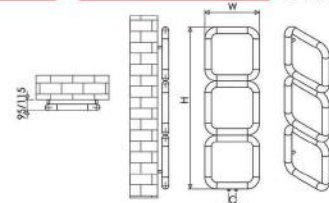

PRODUCT CODE	Height mm	Width mm	Sections	Pipe centers mm	Wall to pipe centers mm	Wall distance mm	Nett weight kg	Fuel type mm	Heat outputs ΔT 50°C Watts Btu	PRICE (ex VAT)	PRICE (ex VAT)
										BRUSHED	POLISHED
BAR 0500 0500 01	500	500	1	50	95-115	125-145	4,3	C	216 778	£ 465	£ 598
BAR 0500 1000 02	1000	500	2	50	95-115	125-145	8,8	C	435 1566	£ 897	£ 1166
BAR 0500 1500 03	1500	500	3	50	95-115	125-145	13	C	657 2365	£ 1197	£ 1556

# PAROS



**MATERIAL**  
STAINLESS STEEL

**STOCK FINISHES**  
BRUSHED/POLISHED

**GUARANTEE**  
20 YEARS

**INSTALLATION**  
VERTICAL

**1-2 DAYS**  
**DELIVERY!**

max. working pressure 10 bar  
max. working temperature 95 °C  
all dimensions are in mm.  
connections 1/2"

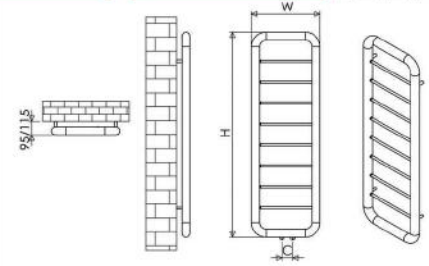

PRODUCT CODE	Height mm	Width mm	Sections	Pipe centers mm	Wall to pipe centers mm	Wall distance mm	Nett weight kg	Fuel type mm	Heat outputs ΔT 50°C Watts Btu	PRICE (ex VAT) BRUSHED	PRICE (ex VAT) POLISHED
PAR 0500 0900 04	900	500	4	50	95-115	125-145	5,7	C	401 1444	£ 630	£ 819
PAR 0500 1200 06	1200	500	6	50	95-115	125-145	7,6	C	484 1742	£ 910	£ 1183
PAR 0500 1500 08	1500	500	8	50	95-115	125-145	9,5	C	568 2045	£ 1120	£ 1456

# AREN



**MATERIAL**  
STAINLESS STEEL

**STOCK FINISHES**  
BRUSHED/POLISHED

**GUARANTEE**  
20 YEARS

**INSTALLATION**  
VERTICAL

**1-2 DAYS**  
**DELIVERY!**

max. working pressure 10 bar  
max. working temperature 95 °C  
all dimensions are in mm.  
connections 1/2"

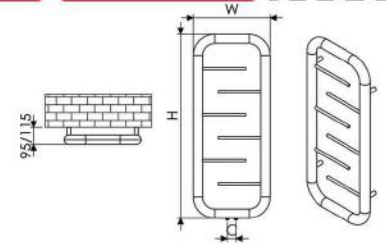

PRODUCT CODE	Height mm	Width mm	Sections	Pipe centers mm	Wall to pipe centers mm	Wall distance mm	Nett weight kg	Fuel type mm	Heat outputs ΔT 50°C Watts Btu	PRICE (ex VAT) BRUSHED	PRICE (ex VAT) POLISHED
ARE 0500 0900 04	900	500	4	50	95-115	125-145	5,7	C	386 1390	£ 650	£ 845
ARE 0500 1200 06	1200	500	6	50	95-115	125-145	7,6	C	498 1793	£ 930	£ 1209
ARE 0500 1500 08	1500	500	8	50	95-115	125-145	9,5	C	536 1930	£ 1150	£ 1495

# REDOX



**MATERIAL**  
STAINLESS STEEL

**STOCK FINISHES**  
BRUSHED/POLISHED

**GUARANTEE**  
20 YEARS

**INSTALLATION**  
HORIZONTAL

**1-2 DAYS**  
**DELIVERY!**

max. working pressure 10 bar  
max. working temperature 95 °C  
all dimensions are in mm.  
connections 1/2"

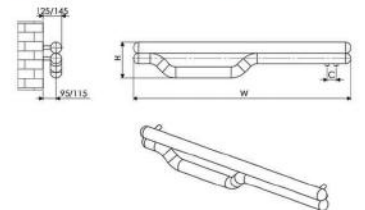

PRODUCT CODE	Height mm	Width mm	Sections	Pipe centers mm	Wall to pipe centers mm	Wall distance mm	Nett weight kg	Fuel type mm	Heat outputs ΔT 50°C Watts Btu	PRICE (ex VAT) BRUSHED	PRICE (ex VAT) POLISHED
RDX 1200 0170 02	170	1200	2	50	95-115	125-145	5,5	C	225 810	£ 786	£ 990

# LEPUS



**MATERIAL**  
STAINLESS STEEL

**STOCK FINISHES**  
BRUSHED/POLISHED

**GUARANTEE**  
20 YEARS

**INSTALLATION**  
HORIZONTAL

**1-2 DAYS**  
**DELIVERY!**

max. working pressure 10 bar  
max. working temperature 95 °C  
all dimensions are in mm.  
connections 1/2"

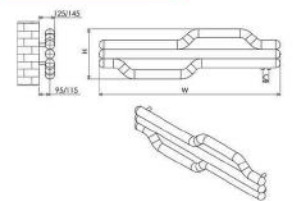

PRODUCT CODE	Height mm	Width mm	Sections	Pipe centers mm	Wall to pipe centers mm	Wall distance mm	Nett weight kg	Fuel type mm	Heat outputs ΔT 50°C Watts Btu	PRICE (ex VAT) BRUSHED	PRICE (ex VAT) POLISHED
LPS 1200 0280 03	280	1200	3	50	95-115	125-145	8,5	C	332 1195	£ 1090	£ 1417

# JACK



<b>MATERIAL</b> STAINLESS STEEL	<b>STOCK FINISHES</b> BRUSHED/POLISHED	<b>GUARANTEE</b> 20 YEARS	<b>INSTALLATION</b> VERTICAL	<b>1-2 DAYS</b> <b>DELIVERY</b>
------------------------------------	---	------------------------------	---------------------------------	------------------------------------

max. working pressure 10 bar  
 max. working temperature 95 °C  
 all dimensions are in mm.  
 connections 1/2"

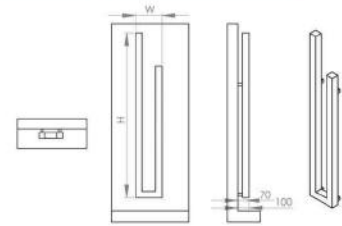

PRODUCT CODE	Height mm	Width mm	Sections	Pipe centers mm	Wall to pipe centers mm	Wall distance mm	Nett weight kg	Fuel type mm	Heat outputs ΔT 50°C		PRICE (ex VAT)	PRICE (ex VAT)
									Watts	Btu	BRUSHED	POLISHED
JAC 0240 1500 02	1500	240	2	50	80-100	110-130	6,9	C	289	1201	£ 599	£ 776

# LINK



<b>MATERIAL</b> STAINLESS STEEL	<b>STOCK FINISHES</b> BRUSHED/POLISHED	<b>GUARANTEE</b> 20 YEARS	<b>INSTALLATION</b> VERTICAL	<b>1-2 DAYS</b> <b>DELIVERY</b>
------------------------------------	---	------------------------------	---------------------------------	------------------------------------

max. working pressure 10 bar  
 max. working temperature 95 °C  
 all dimensions are in mm.  
 connections 1/2"

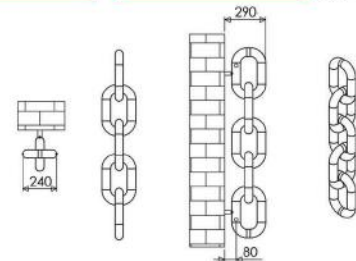

PRODUCT CODE	Height mm	Width mm	Sections	Pipe centers mm	Wall to pipe centers mm	Wall distance mm	Nett weight kg	Fuel type mm	Heat outputs ΔT 50°C		PRICE (ex VAT)	PRICE (ex VAT)
									Watts	Btu	BRUSHED	POLISHED
LNK 0240 0830 03	830	240	3	590	80-110	290-320	6,3	C	199	825	£ 896	£ 1164
LNK 0240 1300 05	1300	240	5	1050	80-110	290-320	10	C	330	1369	£ 1196	£ 1469

# SWING



<b>MATERIAL</b> STAINLESS STEEL	<b>STOCK FINISHES</b> BRUSHED/POLISHED	<b>GUARANTEE</b> 20 YEARS	<b>INSTALLATION</b> HORIZONTAL	<b>1-2 DAYS</b> <b>DELIVERY</b>
------------------------------------	---	------------------------------	-----------------------------------	------------------------------------

max. working pressure 10 bar  
 max. working temperature 95 °C  
 all dimensions are in mm.  
 connections 1/2"

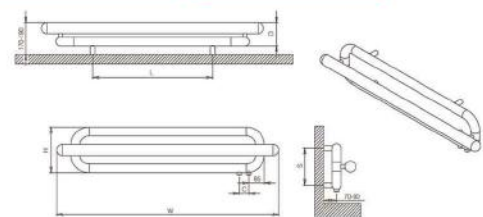

PRODUCT CODE	Height mm	Width mm	Sections	Pipe centers mm	Wall to pipe centers mm	Wall distance mm	Nett weight kg	Fuel type mm	Heat outputs ΔT 50°C		PRICE (ex VAT)	PRICE (ex VAT)
									Watts	Btu	BRUSHED	POLISHED
SWI 1000 0250 01	250	1000	1	50	70-90	170-190	6	C	361	1231	£ 1099	£ 1499

# RONI



**MATERIAL**  
STAINLESS STEEL

**STOCK FINISHES**  
BRUSHED/POLISHED

**GUARANTEE**  
20 YEARS

**INSTALLATION**  
VERTICAL  
HORIZONTAL

**1-2 DAYS**  
DELIVERY

max. working pressure  
max. working temperature  
all dimensions are in  
connections

10 bar  
95 °C  
mm.  
½"

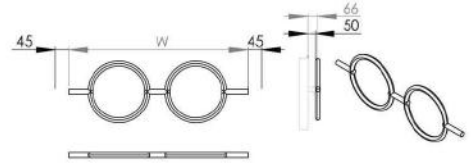

PRODUCT CODE	Height mm	Width mm	Sections	Pipe centers mm	Wall to pipe centers mm	Wall distance mm	Nett weight kg	Fuel type mm	Heat outputs ΔT 50°C Watts Btu	PRICE (ex VAT) BRUSHED	PRICE (ex VAT) POLISHED
ROI 0640 0400 01	400	640	1	730	50-60	66-76	3	C	90 307	£ 399	£ 479
ROI 1000 0400 02	400	1000	2	1090	50-60	66-76	5,8	C	160 546	£ 579	£ 659

# TALENT



**MATERIAL**  
STAINLESS STEEL

**STOCK FINISHES**  
BRUSHED/POLISHED

**GUARANTEE**  
20 YEARS

**INSTALLATION**  
VERTICAL

**1-2 DAYS**  
DELIVERY

max. working pressure  
max. working temperature  
all dimensions are in  
connections

10 bar  
95 °C  
mm.  
½"

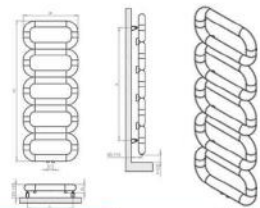

PRODUCT CODE	Height mm	Width mm	Sections	Pipe centers mm	Wall to pipe centers mm	Wall distance mm	Nett weight kg	Fuel type mm	Heat outputs ΔT 50°C Watts Btu	PRICE (ex VAT) BRUSHED	PRICE (ex VAT) POLISHED
TAL 0500 0780 03	780	500	3	50	95-115	125-145	9	C	374 1276	£ 1089	£ 1419
TAL 0500 1040 04	1040	500	4	50	95-115	125-145	12	C	494 1687	£ 1299	£ 1739
TAL 0500 1300 05	1300	500	5	50	95-115	125-145	15	C	614 2098	£ 1599	£ 2089

# JAZZ



**MATERIAL**  
STAINLESS STEEL

**STOCK FINISHES**  
BRUSHED/POLISHED

**GUARANTEE**  
20 YEARS

**INSTALLATION**  
VERTICAL

**1-2 DAYS**  
DELIVERY

max. working pressure  
max. working temperature  
all dimensions are in  
connections

10 bar  
95 °C  
mm.  
½"

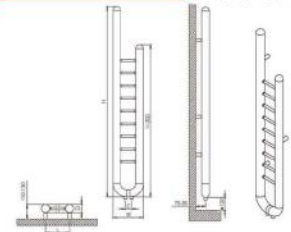

PRODUCT CODE	Height mm	Width mm	Sections	Pipe centers mm	Wall to pipe centers mm	Wall distance mm	Nett weight kg	Fuel type mm	Heat outputs ΔT 50°C Watts Btu	PRICE (ex VAT) BRUSHED	PRICE (ex VAT) POLISHED
JAZ 0240 1500 09	1500	240	9	50	75-95	110-130	7,5	C	356 1211	£ 1089	£ 1499

# KARE



**MATERIAL**  
STAINLESS STEEL

**STOCK FINISHES**  
BRUSHED

**GUARANTEE**  
20 YEARS

**INSTALLATION**  
VERTICAL

**1-2 DAYS**  
DELIVERY

max. working pressure  
max. working temperature  
all dimensions are in  
connections  
heating element usage available

10 bar  
95 °C  
mm.  
½"

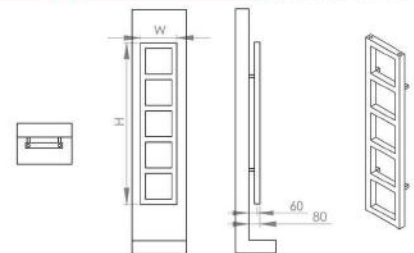

PRODUCT CODE	Height mm	Width mm	Sections	Pipe centers mm	Wall to pipe centers mm	Wall distance mm	Nett weight kg	Fuel type mm	Heat outputs ΔT 50°C Watts Btu	PRICE (ex VAT) BRUSHED
KAE 0270 0856 03	856	270	3	230	60	80	4,5	C/E/D	278 953	£ 303
KAE 0270 1400 05	1400	270	5	230	60	80	7,5	C/E/D	413 1487	£ 440

# IVOR

**MATERIAL**  
STAINLESS STEEL

**STOCK FINISHES**  
BRUSHED/POLISHED

**GUARANTEE**  
20 YEARS

**INSTALLATION**  
VERTICAL

**1-2 DAYS**  
**DELIVERY**



max. working pressure 10 bar  
 max. working temperature 95 °C  
 all dimensions are in mm.  
 connections 1/2"  
 heating element usage available  
 can be mounted left hand side and right hand side

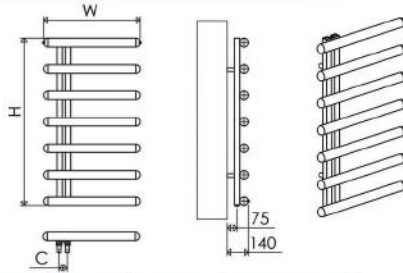

PRODUCT CODE	Height mm	Width mm	Sections	Pipe centers mm	Wall to pipe centers mm	Wall distance mm	Nett weight kg	Fuel type mm	Heat outputs ΔT 50°C Watts Btu	PRICE (ex VAT) BRUSHED	PRICE (ex VAT) POLISHED
IVO 0500 1000 07	1000	500	7	50	75	140	8,5	C/E/D	586 2006	£ 599	£ 718

# VIVI

**MATERIAL**  
STAINLESS STEEL

**STOCK FINISHES**  
BRUSHED/POLISHED

**GUARANTEE**  
20 YEARS

**INSTALLATION**  
VERTICAL

**1-2 DAYS**  
**DELIVERY**



max. working pressure 10 bar  
 max. working temperature 95 °C  
 all dimensions are in mm.  
 connections 1/2"  
 heating element usage available

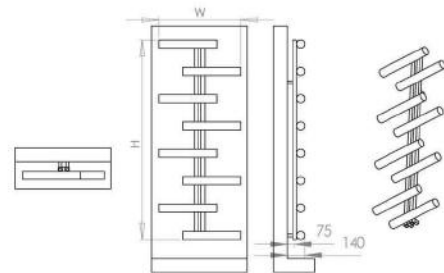

PRODUCT CODE	Height mm	Width mm	Sections	Pipe centers mm	Wall to pipe centers mm	Wall distance mm	Nett weight kg	Fuel type mm	Heat outputs ΔT 50°C Watts Btu	PRICE (ex VAT) BRUSHED	PRICE (ex VAT) POLISHED
VIV 0500 1000 07	1000	500	7	50	75	140	8,5	C/E/D	586 2006	£ 629	£ 754

# ALIAS

**MATERIAL**  
STAINLESS STEEL

**STOCK FINISHES**  
BRUSHED

**GUARANTEE**  
20 YEARS

**INSTALLATION**  
VERTICAL

**1-2 DAYS**  
**DELIVERY**



max. working pressure 10 bar  
 max. working temperature 95 °C  
 all dimensions are in mm.  
 connections 1/2"  
 heating element usage available  
 can be mounted left hand side and right hand side

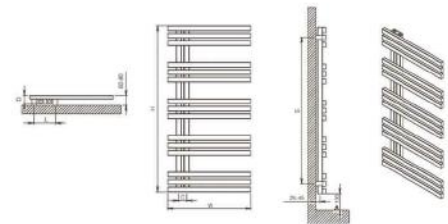

PRODUCT CODE	Height mm	Width mm	Sections	Pipe centers mm	Wall to pipe centers mm	Wall distance mm	Nett weight kg	Fuel type mm	Heat outputs ΔT 50°C Watts Btu	PRICE (ex VAT) BRUSHED
ALI 0500 1000 15	1000	500	15	50	25-45	75	11	C/E/D	529 1806	£ 679

# ADORE

**MATERIAL**  
STAINLESS STEEL

**STOCK FINISHES**  
BRUSHED

**GUARANTEE**  
20 YEARS

**INSTALLATION**  
VERTICAL

**1-2 DAYS**  
**DELIVERY**



max. working pressure 10 bar  
 max. working temperature 95 °C  
 all dimensions are in mm.  
 connections 1/2"  
 heating element usage available  
 can be mounted left hand side and right hand side

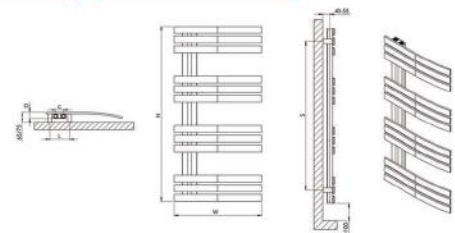

PRODUCT CODE	Height mm	Width mm	Sections	Pipe centers mm	Wall to pipe centers mm	Wall distance mm	Nett weight kg	Fuel type mm	Heat outputs ΔT 50°C Watts Btu	PRICE (ex VAT) BRUSHED
ADO 0500 1000 12	1000	500	12	50	40-55	65	10,5	C/E/D	445 1517	£ 599



# HERRING



**MATERIAL**  
STAINLESS STEEL

**STOCK FINISHES**  
BRUSHED

**GUARANTEE**  
20 YEARS

**INSTALLATION**  
VERTICAL

**1-2 DAYS**  
**DELIVERY**

max. working pressure 10 bar  
max. working temperature 95 °C  
all dimensions are in mm.  
connections 1/2"  
heating element usage available

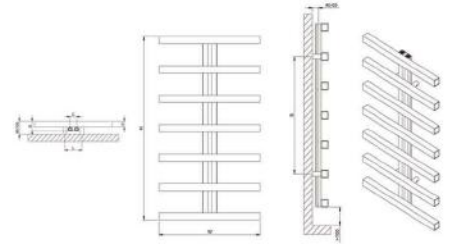

PRODUCT CODE	Height mm	Width mm	Sections	Pipe centers mm	Wall to pipe centers mm	Wall distance mm	Nett weight kg	Fuel type mm	Heat outputs ΔT 50°C Watts Btu	PRICE (ex VAT) BRUSHED
HRR 0600 1000 07	1000	600	7	50	40-55	95-110	12,9	C/E/D	407 1330	£ 599

# ARLEN



**MATERIAL**  
STAINLESS STEEL

**STOCK FINISHES**  
BRUSHED

**GUARANTEE**  
20 YEARS

**INSTALLATION**  
VERTICAL

**1-2 DAYS**  
**DELIVERY**

max. working pressure 10 bar  
max. working temperature 95 °C  
all dimensions are in mm.  
connections 1/2"  
heating element usage available  
can be mounted left hand side and right hand side

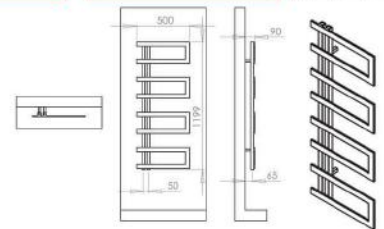

PRODUCT CODE	Height mm	Width mm	Sections	Pipe centers mm	Wall to pipe centers mm	Wall distance mm	Nett weight kg	Fuel type mm	Heat outputs ΔT 50°C Watts Btu	PRICE (ex VAT) BRUSHED
ARL 0500 1000 08	1000	500	8	50	65	90	9,9	C/E/D	526 1800	£ 519

# IBIZA



**MATERIAL**  
STAINLESS STEEL

**STOCK FINISHES**  
BRUSHED

**GUARANTEE**  
20 YEARS

**INSTALLATION**  
VERTICAL

**1-2 DAYS**  
**DELIVERY**

max. working pressure 10 bar  
max. working temperature 95 °C  
all dimensions are in mm.  
connections 1/2"  
heating element usage available  
can be mounted left hand side and right hand side

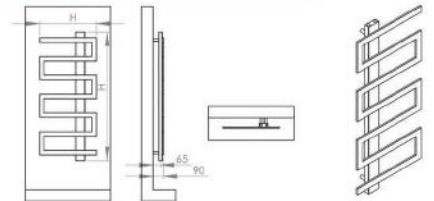

PRODUCT CODE	Height mm	Width mm	Sections	Pipe centers mm	Wall to pipe centers mm	Wall distance mm	Nett weight kg	Fuel type mm	Heat outputs ΔT 50°C Watts Btu	PRICE (ex VAT) BRUSHED
IBZ 0500 0440 03	440	500	3	50	65	90	7,9	C/E/D	236 1324	£ 319
IBZ 0500 0770 05	770	500	5	50	65	90	9,9	C/E/D	377 1288	£ 429
IBZ 0500 1130 07	1130	500	7	50	65	90	12,9	C/E/D	544 1864	£ 579

# IGUANA



**MATERIAL**  
STAINLESS STEEL

**STOCK FINISHES**  
BRUSHED

**GUARANTEE**  
20 YEARS

**INSTALLATION**  
VERTICAL

**1-2 DAYS**  
**DELIVERY**

max. working pressure 10 bar  
max. working temperature 95 °C  
all dimensions are in mm.  
connections 1/2"  
heating element usage available

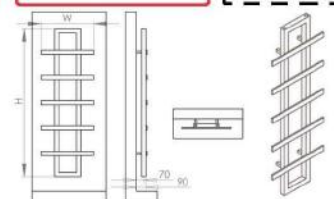

PRODUCT CODE	Height mm	Width mm	Sections	Pipe centers mm	Wall to pipe centers mm	Wall distance mm	Nett weight kg	Fuel type mm	Heat outputs ΔT 50°C Watts Btu	PRICE (ex VAT) BRUSHED
IGU 0500 0940 03	0940	500	3	230	70 - 90	90 - 110	6,2	C/E/D	320 1089	£ 359
IGU 0500 1400 05	1400	500	5	230	70 - 90	90 - 110	9,2	C/E/D	478 1636	£ 499

# KLIPS



**MATERIAL**  
STAINLESS STEEL

**STOCK FINISHES**  
BRUSHED

**GUARANTEE**  
20 YEARS

**INSTALLATION**  
HORIZONTAL

**1-2 DAYS DELIVERY!**

max. working pressure  
max. working temperature  
all dimensions are in  
connections

10 bar  
95 °C  
mm.  
½"

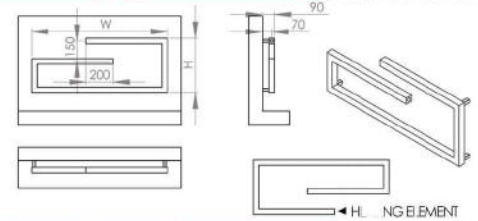

PRODUCT CODE	Height mm	Width mm	Sections	Pipe centers mm	Wall to pipe centers mm	Wall distance mm	Nett weight kg	Fuel type mm	Heat outputs ΔT 50°C Watts Btu	PRICE (ex VAT) BRUSHED
KLP 1000 0400 01	0400	1000	3	150+200(+90)	70-90	90-110	5,5	C/E/D	320 1094	£ 399

# ECLIPSE



**MATERIAL**  
STAINLESS STEEL

**STOCK FINISHES**  
BRUSHED/POLISHED

**GUARANTEE**  
20 YEARS

**INSTALLATION**  
VERTICAL

**1-2 DAYS DELIVERY!**

max. working pressure  
max. working temperature  
all dimensions are in  
connections  
heating element usage available

10 bar  
95 °C  
mm.  
½"

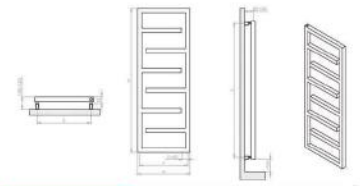

PRODUCT CODE	Height mm	Width mm	Sections	Pipe centers mm	Wall to pipe centers mm	Wall distance mm	Nett weight kg	Fuel type mm	Heat outputs ΔT 50°C Watts Btu	PRICE (ex VAT) BRUSHED	PRICE (ex VAT) POLISHED
ECL 0500 0880 03	0880	500	3	460	80-100	100-120	8,5	C/E	477 1629	£ 529	£ 729
ECL 0500 1370 06	1370	500	6	460	80-100	100-120	11,5	C/E	758 2588	£ 729	£ 939

# SNOWFLAKE



**MATERIAL**  
STAINLESS STEEL

**STOCK FINISHES**  
BRUSHED

**GUARANTEE**  
20 YEARS

**INSTALLATION**  
VERTICAL

**1-2 DAYS DELIVERY!**

max. working pressure  
max. working temperature  
all dimensions are in  
connections

10 bar  
95 °C  
mm.  
½"

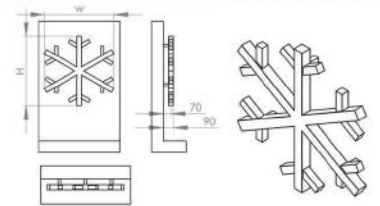

PRODUCT CODE	Height mm	Width mm	Sections	Pipe centers mm	Wall to pipe centers mm	Wall distance mm	Nett weight kg	Fuel type mm	Heat outputs ΔT 50°C Watts Btu	PRICE (ex VAT) BRUSHED
SNW 0600 0600 05	600	600	5	360	70-90	90-110	5,5	C/E/D	272 931	£ 599

## STEEL DESIGNER RADIATORS TECHNICAL SPECIFICATIONS

# FRAME



**MATERIAL**  
STEEL

**STOCK FINISHES**  
CHROME

**GUARANTEE**  
5 YEARS

**INSTALLATION**  
VERTICAL

**1-2 DAYS DELIVERY!**

max. working pressure  
max. working temperature  
all dimensions are in  
connections

10 bar  
95 °C  
mm.  
½"

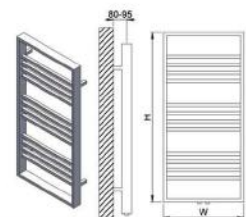

PRODUCT CODE	Height mm	Width mm	Sections	Pipe centers mm	Wall to pipe centers mm	Wall distance mm	Nett weight kg	Fuel type mm	Heat outputs ΔT 50°C Watts Btu	PRICE (ex VAT) CHROME
FRM 0500075008	750	500	8	50	73-88	93 108	4,4	C	320 1093	£ 293
FRM 0500105012	1050	500	12	50	73-88	93 108	6	C	433 1479	£ 335
FRM 0500135016	1350	500	16	50	73-88	93 108	7,6	C	545 1861	£ 398

# THOR



MATERIAL  
STEEL

STOCK FINISHES  
CHROME

GUARANTEE  
5 YEARS

INSTALLATION  
VERTICAL

1-2 DAYS  
DELIVERY

max. working pressure 10 bar  
max. working temperature 95 °C  
all dimensions are in mm.  
connections 1/2"  
heating element usage available

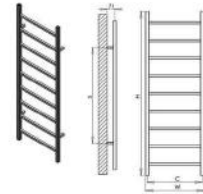

PRODUCT CODE	Height mm	Width mm	Sections	Pipe centers mm	Wall to pipe centers mm	Wall distance mm	Nett weight kg	Fuel type mm	Heat outputs ΔT 50°C Watts Btu	PRICE (ex VAT) CHROME
THR 0500080006	800	500	6	80	68-83	83-98	3,6	C/E/D	225 769	£ 188
THR 0500120009	1200	500	9	80	68-83	83-98	5,1	C/E/D	328 1119	£ 230

# FLORIS



MATERIAL  
STEEL

STOCK FINISHES  
CHROME

GUARANTEE  
5 YEARS

INSTALLATION  
VERTICAL

1-2 DAYS  
DELIVERY

max. working pressure 10 bar  
max. working temperature 95 °C  
all dimensions are in mm.  
connections 1/2"  
heating element usage available  
can be mounted left hand side and right hand side

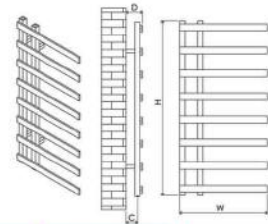

PRODUCT CODE	Height mm	Width mm	Sections	Pipe centers mm	Wall to pipe centers mm	Wall distance mm	Nett weight kg	Fuel type mm	Heat outputs ΔT 50°C Watts Btu	PRICE (ex VAT) CHROME
FLR 0500080006	800	500	6	100	68-83	93-108	5,3	C/E/D	280 956	£ 235
FLR 0500100008	1000	500	8	100	68-83	93-108	6,9	C/E/D	370 1263	£ 282
FLR 0500120010	1200	500	10	100	68-83	93-108	8,5	C/E/D	467 1594	£ 335

# GRADIENT



MATERIAL  
STEEL

STOCK FINISHES  
CHROME

GUARANTEE  
5 YEARS

INSTALLATION  
VERTICAL

1-2 DAYS  
DELIVERY

max. working pressure 10 bar  
max. working temperature 95 °C  
all dimensions are in mm.  
connections 1/2"  
heating element usage available  
can be mounted left hand side and right hand side

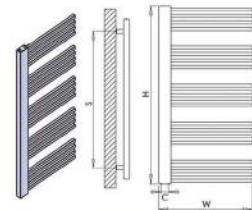

PRODUCT CODE	Height mm	Width mm	Sections	Pipe centers mm	Wall to pipe centers mm	Wall distance mm	Nett weight kg	Fuel type mm	Heat outputs ΔT 50°C Watts Btu	PRICE (ex VAT) CHROME
GRT 0500070012	700	500	12	50	73-88	93-108	5,3	C/E/D	244 833	£ 239
GRT 0500100016	1000	500	16	50	73-88	93-108	7,2	C/E/D	320 1093	£ 339
GRT 0500120020	1200	500	20	50	73-88	93-108	8,1	C/E/D	407 1390	£ 439

# PRIMUS



MATERIAL  
STEEL

STOCK FINISHES  
CHROME

GUARANTEE  
5 YEARS

INSTALLATION  
VERTICAL

1-2 DAYS  
DELIVERY

max. working pressure 10 bar  
max. working temperature 95 °C  
all dimensions are in mm.  
connections 1/2"  
heating element usage available  
can be mounted left hand side and right hand side

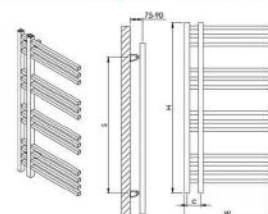

PRODUCT CODE	Height mm	Width mm	Sections	Pipe centers mm	Wall to pipe centers mm	Wall distance mm	Nett weight kg	Fuel type mm	Heat outputs ΔT 50°C Watts Btu	PRICE (ex VAT) CHROME
PRM 0500068809	688	500	9	80	68-83	83-98	4,3	C/E/D	265 903	£ 240
PRM 0500100013	1000	500	13	80	68-83	83-98	6,3	C/E/D	350 1196	£ 272
PRM 0500120015	1200	500	15	80	68-83	83-98	7,3	C/E/D	400 1366	£ 314

# RUBIN



<b>MATERIAL</b> STEEL	<b>STOCK FINISHES</b> CHROME	<b>GUARANTEE</b> 5 YEARS	<b>INSTALLATION</b> VERTICAL	<b>1-2 DAYS DELIVERY</b>
--------------------------	---------------------------------	-----------------------------	---------------------------------	--------------------------

max. working pressure 10 bar  
 max. working temperature 95 °C  
 all dimensions are in mm.  
 connections 1/2"  
 heating element usage available  
 can be mounted left hand side and right hand side

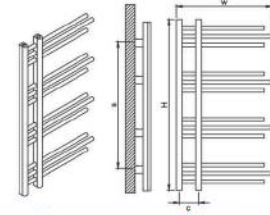

PRODUCT CODE	Height mm	Width mm	Sections	Pipe centers mm	Wall to pipe centers mm	Wall distance mm	Nett weight kg	Fuel type mm	Heat outputs ΔT 50°C Watts Btu	PRICE (ex VAT) CHROME
RUB 0500100012	1000	500	12	100	70-85	93-108	5,7	C/E/D	219 748	£ 195

# ANTARA



<b>MATERIAL</b> STEEL	<b>STOCK FINISHES</b> CHROME	<b>GUARANTEE</b> 5 YEARS	<b>INSTALLATION</b> VERTICAL	<b>NEXT DAY DELIVERY</b>
--------------------------	---------------------------------	-----------------------------	---------------------------------	--------------------------

max. working pressure 10 bar  
 max. working temperature 95 °C  
 all dimensions are in mm.  
 connections 1/2"  
 heating element usage available  
 can be mounted left hand side and right hand side

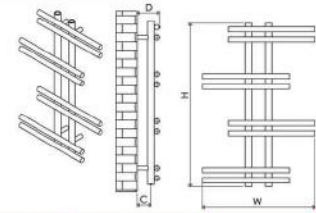

PRODUCT CODE	Height mm	Width mm	Sections	Pipe centers mm	Wall to pipe centers mm	Wall distance mm	Nett weight kg	Fuel type mm	Heat outputs ΔT 50°C Watts Btu	PRICE (ex VAT) CHROME
ANT 0550080008	800	550	8	100	69-84	110-125	4,2	C/E/D	335 1145	£ 240
ANT 0550100010	1000	550	10	100	69-84	110-125	5,2	C/E/D	365 1247	£ 293
ANT 0550120012	1200	550	12	100	69-84	110-125	6,2	C/E/D	437 1495	£ 324

# TANYA



<b>MATERIAL</b> STEEL	<b>STOCK FINISHES</b> CHROME	<b>GUARANTEE</b> 5 YEARS	<b>INSTALLATION</b> VERTICAL	<b>1-2 DAYS DELIVERY</b>
--------------------------	---------------------------------	-----------------------------	---------------------------------	--------------------------

max. working pressure 10 bar  
 max. working temperature 95 °C  
 all dimensions are in mm.  
 connections 1/2"  
 heating element usage available  
 can be mounted left hand side and right hand side

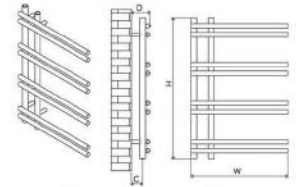

PRODUCT CODE	Height mm	Width mm	Sections	Pipe centers mm	Wall to pipe centers mm	Wall distance mm	Nett weight kg	Fuel type mm	Heat outputs ΔT 50°C Watts Btu	PRICE (ex VAT) CHROME
TNY 0500080008	800	500	8	100	69-84	110-125	3,4	C/E/D	305 1041	£ 320
TNY 0500100010	1000	500	10	100	69-84	110-125	4,2	C/E/D	332 1132	£ 282
TNY 0500120012	1200	500	12	100	69-84	110-125	5,1	C/E/D	398 1359	£ 314

# ALDO

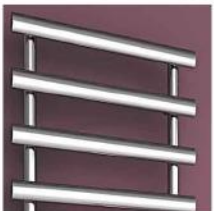

<b>MATERIAL</b> STEEL	<b>STOCK FINISHES</b> CHROME	<b>GUARANTEE</b> 5 YEARS	<b>INSTALLATION</b> VERTICAL	<b>1-2 DAYS DELIVERY</b>
--------------------------	---------------------------------	-----------------------------	---------------------------------	--------------------------

max. working pressure 10 bar  
 max. working temperature 95 °C  
 all dimensions are in mm.  
 connections 1/2"  
 heating element usage available

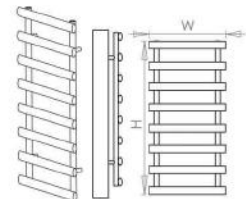

PRODUCT CODE	Height mm	Width mm	Sections	Pipe centers mm	Wall to pipe centers mm	Wall distance mm	Nett weight kg	Fuel type mm	Heat outputs ΔT 50°C Watts Btu	PRICE (ex VAT) CHROME
ALD 0500080006	800	500	6	440	69-84	110-125	5,1	C/E/D	328 1119	£ 230
ALD 0500120009	1200	500	9	440	69-84	110-125	7,7	C/E/D	492 1678	£ 293
ALD 0500160012	1600	500	12	440	69-84	110-125	10,2	C/E/D	656 2237	£ 356

# NERO

MATERIAL  
STEEL

STOCK FINISHES  
CHROME

GUARANTEE  
5 YEARS

INSTALLATION  
VERTICAL

1-2 DAYS  
DELIVERY



max. working pressure 10 bar  
max. working temperature 95 °C  
all dimensions are in mm.  
connections 1/2"  
heating element usage available  
can be mounted left hand side and right hand side

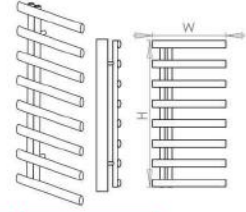

PRODUCT CODE	Height mm	Width mm	Sections	Pipe centers mm	Wall to pipe centers mm	Wall distance mm	Nett weight kg	Fuel type mm	Heat outputs ΔT 50°C Watts Btu	PRICE (ex VAT) CHROME
NRO 0500080006	800	500	6	100	69-84	110-125	5,1	C/E/D	328 1119	£ 240
NRO 0500120009	1200	500	9	100	69-84	110-125	7,7	C/E/D	492 1678	£ 303
NRO 0500160012	1600	500	12	100	69-84	110-125	10,2	C/E/D	656 2237	£ 366

# VALENCIA

MATERIAL  
STEEL

STOCK FINISHES  
CHROME

GUARANTEE  
5 YEARS

INSTALLATION  
VERTICAL

1-2 DAYS  
DELIVERY



max. working pressure 10 bar  
max. working temperature 95 °C  
all dimensions are in mm.  
connections 1/2"  
heating element usage available

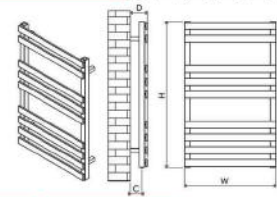

PRODUCT CODE	Height mm	Width mm	Sections	Pipe centers mm	Wall to pipe centers mm	Wall distance mm	Nett weight kg	Fuel type mm	Heat outputs ΔT 50°C Watts Btu	PRICE (ex VAT) CHROME
VAL 0500080009	800	500	9	470	68-83	93-108	6,9	C/E/D	219 749	£ 272
VAL 0500115012	1150	500	12	470	68-83	93-108	9,5	C/E/D	330 1124	£ 356

# VERONA

MATERIAL  
STEEL

STOCK FINISHES  
CHROME

GUARANTEE  
5 YEARS

INSTALLATION  
VERTICAL

1-2 DAYS  
DELIVERY



max. working pressure 10 bar  
max. working temperature 95 °C  
all dimensions are in mm.  
connections 1/2"  
heating element usage available  
can be mounted left hand side and right hand side

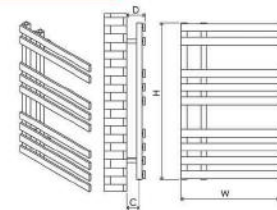

PRODUCT CODE	Height mm	Width mm	Sections	Pipe centers mm	Wall to pipe centers mm	Wall distance mm	Nett weight kg	Fuel type mm	Heat outputs ΔT 50°C Watts Btu	PRICE (ex VAT) CHROME
VRN 0500080009	800	500	9	100	68-83	93-108	6,9	C/E/D	219 749	£ 282
VRN 0500115012	1150	500	12	100	68-83	93-108	9,5	C/E/D	330 1124	£ 366

# ETAGE

MATERIAL  
STEEL

STOCK FINISHES  
CHROME

GUARANTEE  
5 YEARS

INSTALLATION  
VERTICAL

1-2 DAYS  
DELIVERY



max. working pressure 10 bar  
max. working temperature 95 °C  
all dimensions are in mm.  
connections 1/2"  
heating element usage available



PRODUCT CODE	Height mm	Width mm	Sections	Pipe centers mm	Wall to pipe centers mm	Wall distance mm	Nett weight kg	Fuel type mm	Heat outputs ΔT 50°C Watts Btu	PRICE (ex VAT) CHROME
ETG 0500035005	350	500	5	470	65-80	300-315	3	C/E/D	145 495	£ 240

# VICTORIA

MATERIAL  
STEEL

STOCK FINISHES  
CHROME

GUARANTEE  
5 YEARS

INSTALLATION  
VERTICAL

1-2 DAYS  
DELIVERY



max. working pressure 10 bar  
max. working temperature 95 °C  
all dimensions are in mm.  
connections 1/2"  
heating element usage available

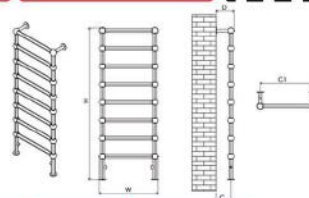

PRODUCT CODE	Height mm	Width mm	Sections	Pipe centers mm	Wall to pipe centers mm	Wall distance mm	Nett weight kg	Fuel type mm	Heat outputs ΔT 50°C Watts Btu	PRICE (ex VAT) CHROME
VCT 0500095005	950	500	5	365	141	165	3,4	C	156 533	£ 387
VCT 0500134007	1340	500	7	365	141	165	6	C	273 932	£ 492

# VINTAGE

MATERIAL  
STEEL

STOCK FINISHES  
CHROME

GUARANTEE  
5 YEARS

INSTALLATION  
VERTICAL

1-2 DAYS  
DELIVERY



max. working pressure 10 bar  
max. working temperature 95 °C  
all dimensions are in mm.  
connections 1/2"  
heating element usage available



PRODUCT CODE	Height mm	Width mm	Sections	Pipe centers mm	Wall to pipe centers mm	Wall distance mm	Nett weight kg	Fuel type mm	Heat outputs ΔT 50°C Watts Btu	PRICE (ex VAT) CHROME
VTG 0650080008	800	650	3+5	575	141	165	6,1	C	296 1012	£ 324
VTG2 0650065003	650	650	3	575	141	165	3,7	C	172 586	£ 261

# EDWARD

MATERIAL  
STEEL

STOCK FINISHES  
CHROME

GUARANTEE  
5 YEARS

INSTALLATION  
VERTICAL

1-2 DAYS  
DELIVERY



max. working pressure 10 bar  
max. working temperature 95 °C  
all dimensions are in mm.  
connections 1/2"  
heating element usage available

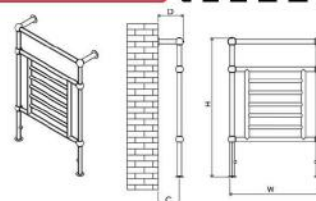

PRODUCT CODE	Height mm	Width mm	Sections	Pipe centers mm	Wall to pipe centers mm	Wall distance mm	Nett weight kg	Fuel type mm	Heat outputs ΔT 50°C Watts Btu	PRICE (ex VAT) CHROME
EDW 0650095003	950	650	3+5	506	141	165	6	C	281 959	£ 356

# BARKOD

MATERIAL  
STEEL

STOCK FINISHES  
TXA

GUARANTEE  
5 YEARS

INSTALLATION  
VERTICAL/  
HORIZONTAL

1-2 DAYS  
DELIVERY



max. working pressure 10 bar  
max. working temperature 95 °C  
all dimensions are in mm.  
connections 1/2"  
heating element usage available

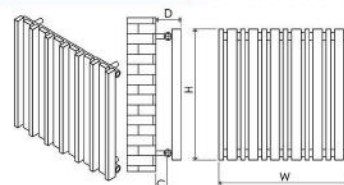

PRODUCT CODE	Height mm	Width mm	Sections	Pipe centers mm	Wall to pipe centers mm	Wall distance mm	Nett weight kg	Fuel type mm	Heat outputs ΔT 50°C Watts Btu	PRICE (ex VAT) ANTHRACITE
BRK 0290180007	1800	290	7	380	69-84	125-140	11,9	C/E/D	847 2891	£ 303
BRK 0470180011	1800	470	11	560	69-84	125-140	18,7	C/E/D	1333 4549	£ 345
BRK 0560055013	550	560	13	650	69-84	125-140	7,6	C/E/D	530 1808	£ 219
BRK 0830055019	550	830	19	920	69-84	125-140	11,2	C/E/D	776 2648	£ 282
BRK 1010055023	550	1010	23	1100	69-84	125-140	13,5	C/E/D	940 3208	£ 345

# MAYRA



MATERIAL  
**STEEL**

STOCK FINISHES  
**CHROME**

GUARANTEE  
**5 YEARS**

INSTALLATION  
**VERTICAL/  
HORIZONTAL**

**1-2 DAYS  
DELIVERY**

max. working pressure 10 bar  
max. working temperature 95 °C  
all dimensions are in mm.  
connections 1/2"  
heating element usage available

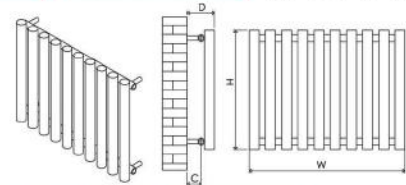

PRODUCT CODE	Height mm	Width mm	Sections	Pipe centers mm	Wall to pipe centers mm	Wall distance mm	Nett weight kg	Fuel type mm	Heat outputs ΔT 50°C Watts Btu	PRICE (ex VAT) CHROME
MYR 0270180004	1800	270	4	360	69-84	140-155	12,2	C/E/D	1021 3480	£ 356
MYR 0420180006	1800	420	6	510	69-84	140-155	18,3	C/E/D	1460 4976	£ 419
MYR 0720055010	550	720	10	810	69-84	140-155	10,5	C/E/D	807 2756	£ 293
MYR 1020055014	550	1020	14	1110	69-84	140-155	14,7	C/E/D	1132 3864	£ 398

# NILE



MATERIAL  
**STEEL**

STOCK FINISHES  
**CHR**

GUARANTEE  
**5 YEARS**

INSTALLATION  
**VERTICAL**

**1-2 DAYS  
DELIVERY**

max. working pressure 10 bar  
max. working temperature 95 °C  
all dimensions are in mm.  
connections 1/2"  
heating element usage available

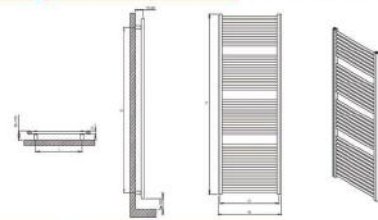

PRODUCT CODE	Height mm	Width mm	Sections	Pipe centers mm	Wall to pipe centers mm	Wall distance mm	Nett weight kg	Fuel type mm	Heat outputs ΔT 50°C Watts Btu	PRICE (ex VAT) chrome 1-25 pcs
NIL0400 0800 12	800	400	12	355	70-90	85-105	6,6	C/E/D	268 914	£ 63
NIL0400 1200 18	1200	400	18	355	70-90	85-105	8,9	C/E/D	385 1312	£ 77
NIL0400 1600 24	1600	400	24	355	70-90	85-105	11,6	C/E/D	508 1734	£ 106
NIL0500 0800 12	800	500	12	455	70-90	85-105	7,6	C/E/D	317 1081	£ 69
NIL0500 1200 18	1200	500	18	455	70-90	85-105	10,2	C/E/D	454 1548	£ 80
NIL0500 1600 24	1600	500	24	455	70-90	85-105	12,9	C/E/D	599 2044	£ 114
NIL0600 0800 12	800	600	12	555	70-90	85-105	8,6	C/E/D	367 1253	£ 72
NIL0600 1200 18	1200	600	18	555	70-90	85-105	13,8	C/E/D	526 1795	£ 86
NIL0600 1600 24	1600	600	24	555	70-90	85-105	14,1	C/E/D	695 2371	£ 117

# DORA



MATERIAL  
**STAINLESS STEEL**

STOCK FINISHES  
**MATC/TXLG**

GUARANTEE  
**5 YEARS**

INSTALLATION  
**VERTICAL**

**1-2 DAYS  
DELIVERY**

max. working pressure 10 bar  
max. working temperature 95 °C  
all dimensions are in mm.  
connections 1/2"  
heating element usage available

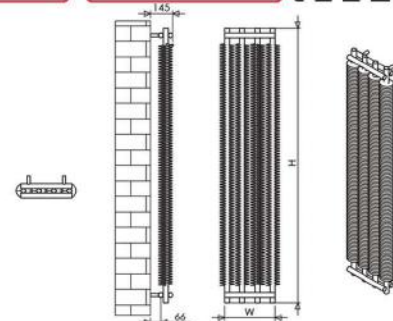

PRODUCT CODE	Height mm	Width mm	Sections	Pipe centers mm	Wall to pipe centers mm	Wall distance mm	Nett weight kg	Fuel type mm	Heat outputs ΔT 50°C Watts Btu	PRICE (ex VAT)
DOR 0290 1800 03	1800	290	3	380	66	145	33,5	C	706 2543	£ 439
DOR 0390 1800 04	1800	390	4	480	66	145	44,7	C	942 3391	£ 463
DOR 0490 1800 05	1800	490	5	580	66	145	56	C	1178 4240	£ 503

# BESPOKE STAINLESS STEEL DESIGNER RADIATORS TECHNICAL SPECIFICATIONS

## UNIQUE

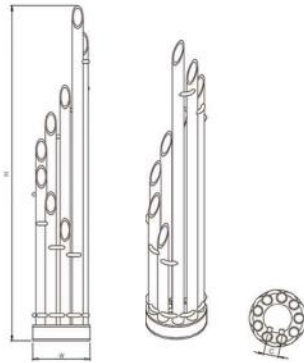

**MATERIAL**  
STAINLESS STEEL

**GUARANTEE**  
20 YEARS

**6-8 WEEKS**  
**DELIVERY**

max. working pressure 10 bar A full range of made to order sizes available.  
max. working temperature 95 °C Please ask for details.  
connections ½"

PRODUCT CODE	Height mm	Width mm	Heat outputs ΔT 50°C Watts Btu	PRICE ( ex VAT )
UNQ 0360190009	1900	360	2912 9937	£ 7874

## TRIA

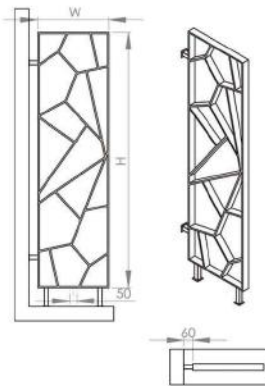

**MATERIAL**  
STAINLESS STEEL

**GUARANTEE**  
20 YEARS

**4-6 WEEKS**  
**DELIVERY**

max. working pressure 10 bar A full range of made to order sizes available.  
max. working temperature 95 °C Please ask for details.  
connections ½" heating element usage available

PRODUCT CODE	Height mm	Width mm	Heat outputs ΔT 50°C Watts Btu	PRICE ( ex VAT )
TRA 0500180023	1800	500	862 2941	£ 2298

## SQUA

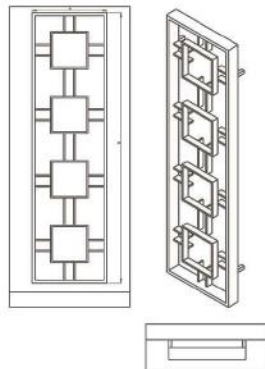

**MATERIAL**  
STAINLESS STEEL

**GUARANTEE**  
20 YEARS

**4-6 WEEKS**  
**DELIVERY**

max. working pressure 10 bar A full range of made to order sizes available.  
max. working temperature 95 °C Please ask for details.  
connections ½"

PRODUCT CODE	Height mm	Width mm	Heat outputs ΔT 50°C Watts Btu	PRICE ( ex VAT )
SQU 0500090002	900	500	704 2400	£ 1238
SQU 0500135003	1350	500	1085 3702	£ 1553
SQU 0500180004	1800	500	1738 5930	£ 2078

## PIANO

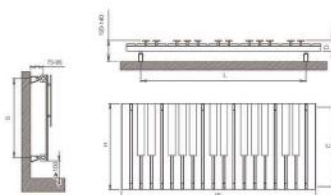

**MATERIAL**  
STAINLESS STEEL

**GUARANTEE**  
20 YEARS

**4-6 WEEKS**  
**DELIVERY**

max. working pressure 10 bar A full range of made to order sizes available.  
max. working temperature 95 °C Please ask for details.  
connections ½" heating element usage available

PRODUCT CODE	Height mm	Width mm	Heat outputs ΔT 50°C Watts Btu	PRICE ( ex VAT )
PIA 1130050019	500	1130	1020 3481	£ 1301
PIA 1130060019	600	1130	1185 4043	£ 1364



# APRIL

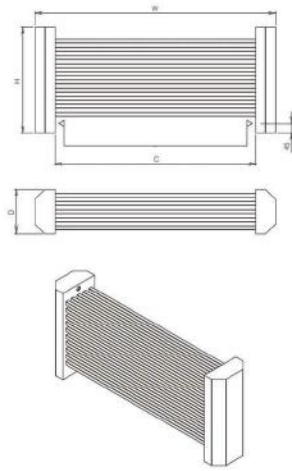

**MATERIAL**  
STAINLESS STEEL

**GUARANTEE**  
20 YEARS

**4-6 WEEKS**  
**DELIVERY**

max. working pressure 10 bar A full range of made to order sizes available.  
 max. working temperature 95 °C Please ask for details.  
 connections ½"

PRODUCT CODE	Height mm	Width mm	Heat outputs ΔT 50°C Watts Btu	PRICE (ex VAT)
APR 1200050023	500	1200	1327 4527	£ 1784
APR 1200050031	500	1200	1788 6100	£ 2172
APR 1200050047	500	1200	2711 9248	£ 2939

# ABAKO

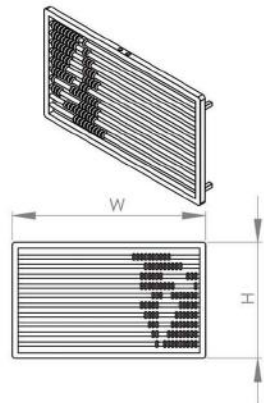

**MATERIAL**  
STAINLESS STEEL

**GUARANTEE**  
20 YEARS

**4-6 WEEKS**  
**DELIVERY**

max. working pressure 10 bar A full range of made to order sizes available.  
 max. working temperature 95 °C Please ask for details.  
 connections ½" heating element usage available

PRODUCT CODE	Height mm	Width mm	Heat outputs ΔT 50°C Watts Btu	PRICE (ex VAT)
ABK1000060010	600	1000	570 1945	£ 1154

# ARCO

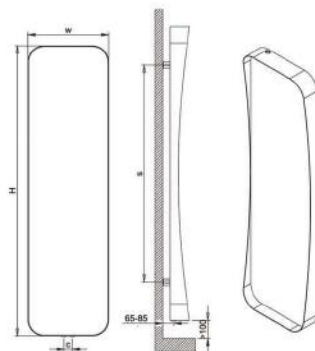

**MATERIAL**  
STAINLESS STEEL

**GUARANTEE**  
20 YEARS

**4-6 WEEKS**  
**DELIVERY**

max. working pressure 10 bar A full range of made to order sizes available.  
 max. working temperature 95 °C Please ask for details.  
 connections ½"

PRODUCT CODE	Height mm	Width mm	Heat outputs ΔT 50°C Watts Btu	PRICE (ex VAT)
ARC 05001800	1800	500	975 3330	£ 2393

# ZIGZAG

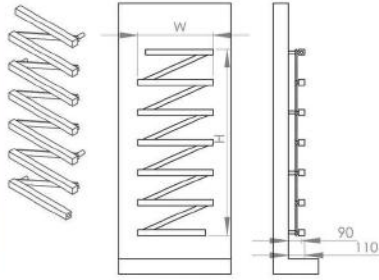

**MATERIAL**  
STAINLESS STEEL

**GUARANTEE**  
20 YEARS

**4-6 WEEKS**  
**DELIVERY**

max. working pressure 10 bar A full range of made to order sizes available.  
 max. working temperature 95 °C Please ask for details.  
 connections ½" May slightly jiggle after you assembly

PRODUCT CODE	Height mm	Width mm	Heat outputs ΔT 50°C Watts Btu	PRICE (ex VAT)
ZIG 0500064003	640	500	281 958	£ 335
ZIG 0500124006	1240	500	517 1765	£ 503
ZIG 0500164008	1640	500	676 2307	£ 734

# PIAZZE

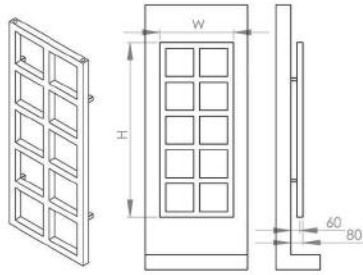

**MATERIAL**  
STAINLESS STEEL

**GUARANTEE**  
20 YEARS

**4-6 WEEKS**  
**DELIVERY**

max. working pressure 10 bar A full range of made to order sizes available.  
 max. working temperature 95 °C Please ask for details.  
 connections ½" heating element usage available

PRODUCT CODE	Height mm	Width mm	Heat outputs ΔT 50°C Watts Btu	PRICE (ex VAT)
PIZ 0500087006	870	500	466 1592	£ 399
PIZ 0500141010	1410	500	735 2507	£ 589
PIZ 0500195014	1950	500	1002 3420	£ 799

# WOODSTOCK

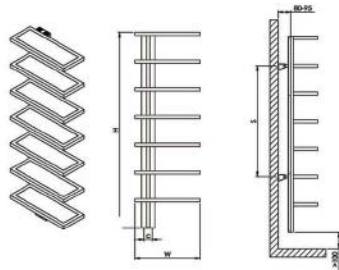

**MATERIAL**  
STAINLESS STEEL

**GUARANTEE**  
20 YEARS

**4-6 WEEKS**  
**DELIVERY**

max. working pressure 10 bar A full range of made to order sizes available.  
 max. working temperature 95 °C Please ask for details.  
 connections ½" heating element usage available  
 Wall distance 245 / 255 mm.

PRODUCT CODE	Height mm	Width mm	Heat outputs ΔT 50°C Watts Btu	PRICE (ex VAT)
WDS 0400120007	1200	400	417 1424	£ 1007

# GRACE

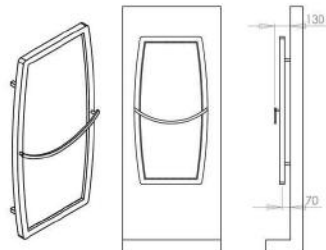

**MATERIAL**  
STAINLESS STEEL

**GUARANTEE**  
20 YEARS

**4-6 WEEKS**  
**DELIVERY**

max. working pressure 10 bar A full range of made to order sizes available.  
 max. working temperature 95 °C Please ask for details.  
 connections ½"

PRODUCT CODE	Height mm	Width mm	Heat outputs ΔT 50°C Watts Btu	PRICE (ex VAT)
GRA 07201000	1000	720	958 3270	£ 944

# CLASICO

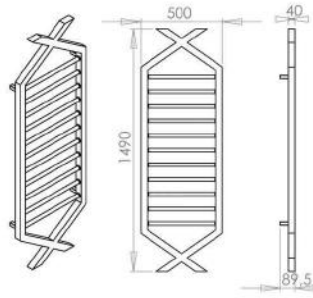

**MATERIAL**  
STAINLESS STEEL

**GUARANTEE**  
20 YEARS

**4-6 WEEKS**  
**DELIVERY**

max. working pressure 10 bar A full range of made to order sizes available.  
max. working temperature 95 °C Please ask for details.  
connections 1/2"

PRODUCT CODE	Height mm	Width mm	Heat outputs ΔT 50°C Watts Btu	PRICE (ex VAT)
CLO 0500149010	1490	500	529 1804	£ 1049

# UNA

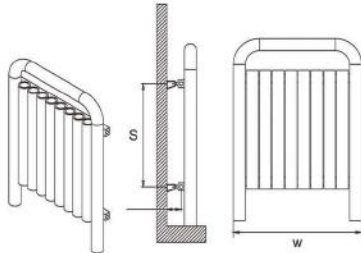

**MATERIAL**  
STAINLESS STEEL

**GUARANTEE**  
20 YEARS

**4-6 WEEKS**  
**DELIVERY**

max. working pressure 10 bar A full range of made to order sizes available.  
max. working temperature 95 °C Please ask for details.  
connections 1/2" heating element usage available

PRODUCT CODE	Height mm	Width mm	Heat outputs ΔT 50°C Watts Btu	PRICE (ex VAT)
UNA 0320092005	920	320	584 1993	£ 1154
UNA 0515092008	920	515	902 3079	£ 1469
UNA 0645092010	920	645	1114 3800	£ 1679

# PAN

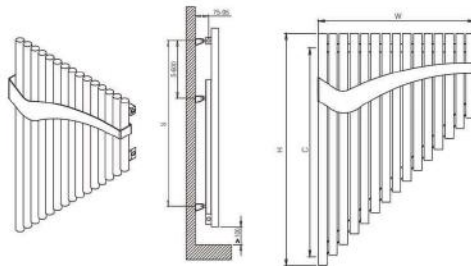

**MATERIAL**  
STAINLESS STEEL

**GUARANTEE**  
20 YEARS

**4-6 WEEKS**  
**DELIVERY**

max. working pressure 10 bar A full range of made to order sizes available.  
max. working temperature 95 °C Please ask for details.  
connections 1/2" heating element usage available

PRODUCT CODE	Height mm	Width mm	Heat outputs ΔT 50°C Watts Btu	PRICE (ex VAT)
PAN 0740110015	1100	740	1080 3686	£ 1364

# DOMINO

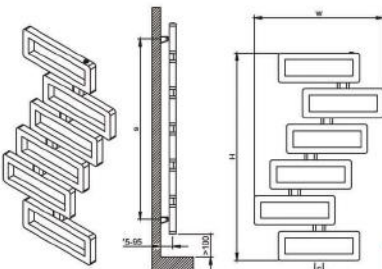

**MATERIAL**  
STAINLESS STEEL

**GUARANTEE**  
20 YEARS

**4-6 WEEKS**  
**DELIVERY**

max. working pressure 10 bar A full range of made to order sizes available.  
max. working temperature 95 °C Please ask for details.  
connections 1/2"

PRODUCT CODE	Height mm	Width mm	Heat outputs ΔT 50°C Watts Btu	PRICE (ex VAT)
DOM 0800128006	1280	800	505 1723	£ 1343

# CLASH

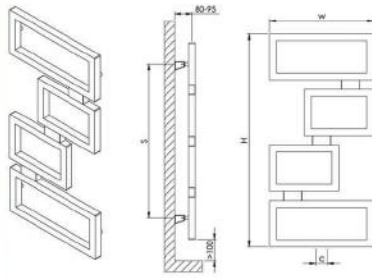

**MATERIAL**  
STAINLESS STEEL

**GUARANTEE**  
20 YEARS

**4-6 WEEKS**  
**DELIVERY**

max. working pressure 10 bar A full range of made to order sizes available.  
max. working temperature 95 °C Please ask for details.  
connections 1/2"

PRODUCT CODE	Height mm	Width mm	Heat outputs ΔT 50°C Watts Btu	PRICE (ex VAT)
CLS 0450092004	920	450	265 905	£ 503

# BECK

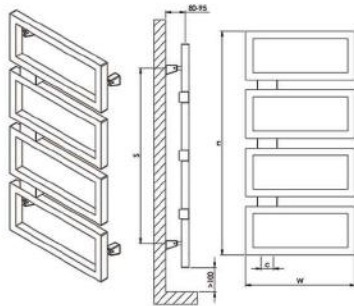

**MATERIAL**  
STAINLESS STEEL

**GUARANTEE**  
20 YEARS

**4-6 WEEKS**  
**DELIVERY**

max. working pressure 10 bar A full range of made to order sizes available.  
max. working temperature 95 °C Please ask for details.  
connections 1/2"

PRODUCT CODE	Height mm	Width mm	Heat outputs ΔT 50°C Watts Btu	PRICE (ex VAT)
BCK 0450092004	920	450	301 1025	£ 503
BCK 0450140006	1400	450	452 1541	£ 713

# FLAP

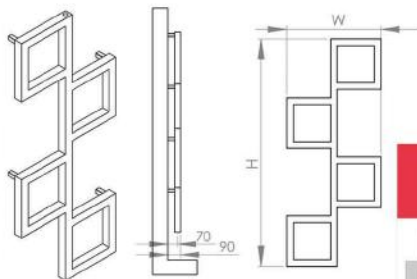

**MATERIAL**  
STAINLESS STEEL

**GUARANTEE**  
20 YEARS

**4-6 WEEKS**  
**DELIVERY**

max. working pressure 10 bar A full range of made to order sizes available.  
max. working temperature 95 °C Please ask for details.  
connections 1/2" heating element usage available

PRODUCT CODE	Height mm	Width mm	Heat outputs ΔT 50°C Watts Btu	PRICE (ex VAT)
FLP 0840085002	850	840	354 1208	£ 303
FLP 0840130003	1300	840	531 1812	£ 408
FLP 0840175004	1750	840	709 2419	£ 513

# RUMA

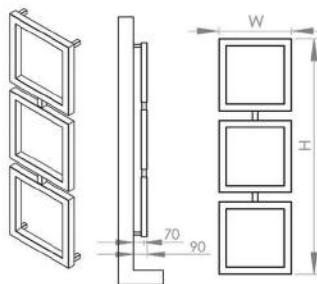

**MATERIAL**  
STAINLESS STEEL

**GUARANTEE**  
20 YEARS

**4-6 WEEKS**  
**DELIVERY**

max. working pressure 10 bar A full range of made to order sizes available.  
max. working temperature 95 °C Please ask for details.  
connections 1/2"

PRODUCT CODE	Height mm	Width mm	Heat outputs ΔT 50°C Watts Btu	PRICE (ex VAT)
RUM 0400085002	840	400	354 1208	£ 303
RUM 0400130003	1280	400	531 1812	£ 408
RUM 0400175004	1720	400	709 2419	£ 513

# TODOR

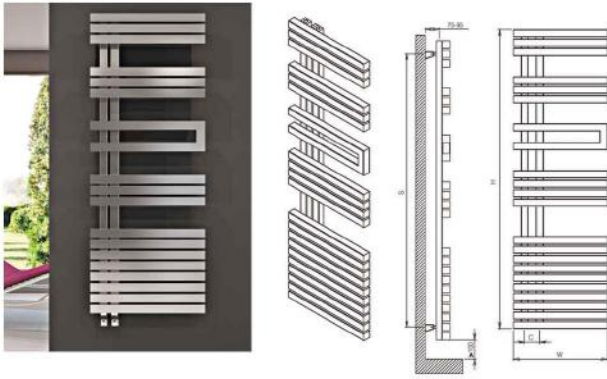

**MATERIAL**  
STAINLESS STEEL

**GUARANTEE**  
20 YEARS

**4-6 WEEKS**  
**DELIVERY**

max. working pressure 10 bar A full range of made to order sizes available.  
max. working temperature 95 °C Please ask for details.  
connections 1/2" heating element usage available

PRODUCT CODE	Height mm	Width mm	Heat outputs ΔT 50°C Watts Btu	PRICE ( ex VAT )
TOD 0500089013	890	500	933 3183	£ 996
TOD 0500114016	1140	500	1156 3944	£ 1259
TOD 0500139019	1390	500	1379 4708	£ 1448
TOD 0500159022	1590	500	1604 5471	£ 1679

# EXODUS

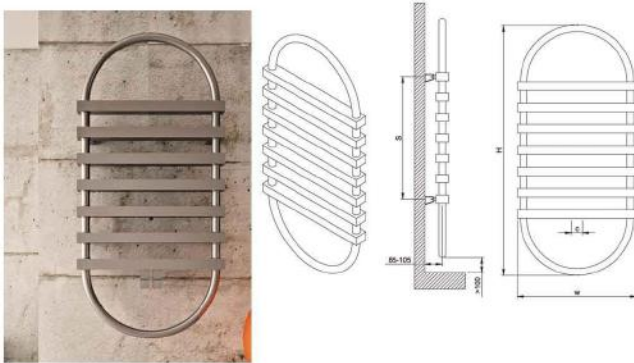

**MATERIAL**  
STAINLESS STEEL

**GUARANTEE**  
20 YEARS

**4-6 WEEKS**  
**DELIVERY**

max. working pressure 10 bar A full range of made to order sizes available.  
max. working temperature 95 °C Please ask for details.  
connections 1/2"

PRODUCT CODE	Height mm	Width mm	Heat outputs ΔT 50°C Watts Btu	PRICE ( ex VAT )
EXD 0560117007	1170	560	443 1512	£ 1049

# CASTOR

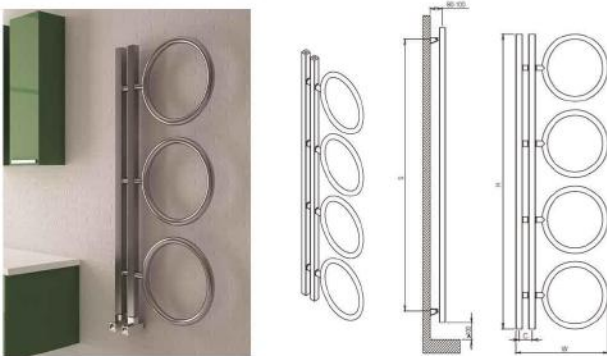

**MATERIAL**  
STAINLESS STEEL

**GUARANTEE**  
20 YEARS

**4-6 WEEKS**  
**DELIVERY**

max. working pressure 10 bar A full range of made to order sizes available.  
max. working temperature 95 °C Please ask for details.  
connections 1/2" heating element usage available

PRODUCT CODE	Height mm	Width mm	Heat outputs ΔT 50°C Watts Btu	PRICE ( ex VAT )
CAS 0560085002	850	560	379 1293	£ 1038
CAS 0560130003	1300	560	574 1959	£ 1322
CAS 0560175004	1750	560	770 2626	£ 1679

# ENVIRON

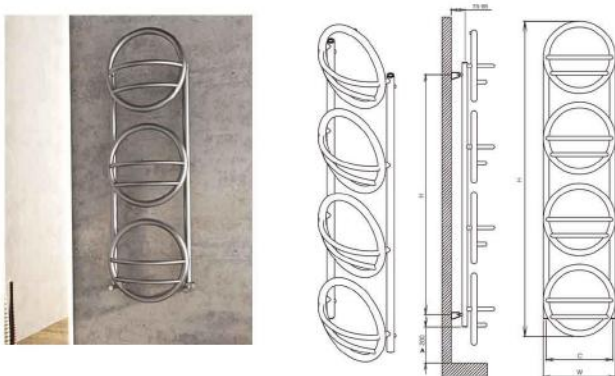

**MATERIAL**  
STAINLESS STEEL

**GUARANTEE**  
20 YEARS

**4-6 WEEKS**  
**DELIVERY**

max. working pressure 10 bar A full range of made to order sizes available.  
max. working temperature 95 °C Please ask for details.  
connections 1/2" heating element usage available

PRODUCT CODE	Height mm	Width mm	Heat outputs ΔT 50°C Watts Btu	PRICE ( ex VAT )
ENV 0400085002	850	400	374 1274	£ 1038
ENV 0400130003	1300	400	564 1924	£ 1322
ENV 0400175004	1750	400	754 2571	£ 1679

# ORIS

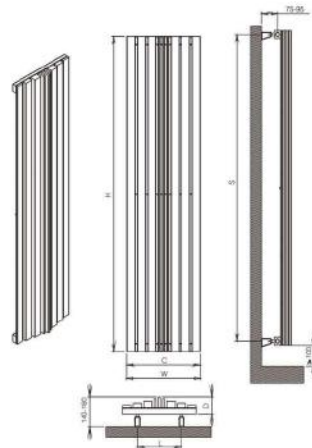

**MATERIAL**  
STAINLESS STEEL

**GUARANTEE**  
20 YEARS

**4-6 WEEKS**  
**DELIVERY**

max. working pressure 10 bar A full range of made to order sizes available.  
max. working temperature 95 °C Please ask for details.  
connections ½"

PRODUCT CODE	Height mm	Width mm	Heat outputs ΔT 50°C Watts Btu	PRICE (ex VAT)
ORI 0350100009	1000	350	831 2840	£ 1007
ORI 0350150009	1500	350	1218 4161	£ 1122
ORI 0350180009	1800	350	1448 4942	£ 1185
ORI 0350200009	2000	350	1604 5477	£ 1269

# VERSAILLES

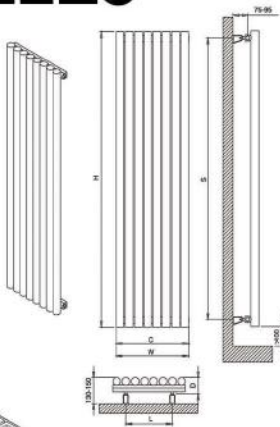

**MATERIAL**  
STAINLESS STEEL

**GUARANTEE**  
20 YEARS

**4-6 WEEKS**  
**DELIVERY**

max. working pressure 10 bar A full range of made to order sizes available.  
max. working temperature 95 °C Please ask for details.  
connections ½"

PRODUCT CODE	Height mm	Width mm	Heat outputs ΔT 50°C Watts Btu	PRICE (ex VAT)
VER 0370100008	1000	370	777 2653	£ 786
VER 0370150008	1500	370	1058 3612	£ 923
VER 0370180008	1800	370	1179 4028	£ 986
VER 0370200008	2000	370	1227 4190	£1028

# FORTE



**MATERIAL**  
STAINLESS STEEL

**GUARANTEE**  
20 YEARS

**4-6 WEEKS**  
**DELIVERY**

max. working pressure 10 bar A full range of made to order sizes available.  
max. working temperature 95 °C Please ask for details.  
connections ½"

PRODUCT CODE	Height mm	Width mm	Heat outputs ΔT 50°C Watts Btu	PRICE (ex VAT)
FRT 0550060008	600	550	1128 3848	£ 1364
FRT 0690060010	600	690	1390 4743	£ 1700
FRT 0830060012	600	830	1650 5631	£ 2025
FRT 0970060014	600	970	1912 6523	£ 2340
FRT 1110060016	600	1110	2174 7417	£ 2645
FRT 1390060020	600	1390	2696 9198	£ 3128

# FUTURA

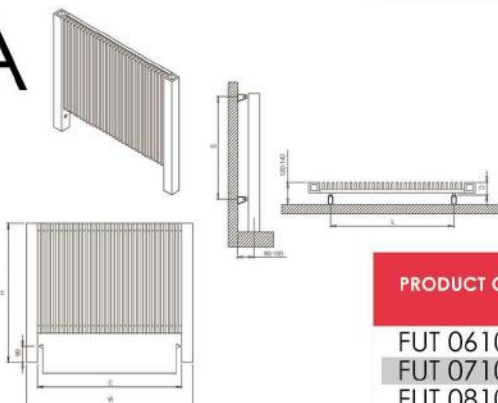

**MATERIAL**  
STAINLESS STEEL

**GUARANTEE**  
20 YEARS

**4-6 WEEKS**  
**DELIVERY**

max. working pressure 10 bar A full range of made to order sizes available.  
max. working temperature 95 °C Please ask for details.  
connections ½"

PRODUCT CODE	Height mm	Width mm	Heat outputs ΔT 50°C Watts Btu	PRICE (ex VAT)
FUT 0610076021	760	610	992 3385	£ 1364
FUT 0710076025	760	710	1144 3904	£ 1563
FUT 0810076029	760	810	1278 4359	£ 1763
FUT 0910076033	760	910	1413 4820	£ 1973
FUT 1110076041	760	1110	1548 5280	£ 2319

# KEOPS

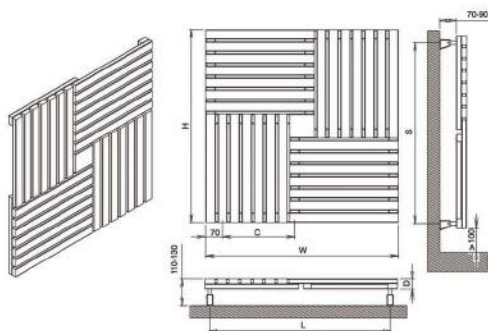

**MATERIAL**  
STAINLESS STEEL

**GUARANTEE**  
20 YEARS

**4-6 WEEKS**  
**DELIVERY**

max. working pressure 10 bar  
max. working temperature 95 °C  
connections ½"

A full range of made to order sizes available.  
Please ask for details.

PRODUCT CODE	Height mm	Width mm	Heat outputs ΔT 50°C Watts Btu	PRICE (ex VAT)
KEO0600060020	600	600	851 2904	£ 944
KEO0700070024	700	700	1110 3787	£ 1122
KEO0800080028	800	800	1406 4796	£ 1458

# HERMES

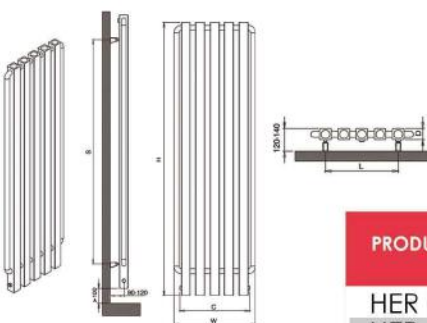

**MATERIAL**  
STAINLESS STEEL

**GUARANTEE**  
20 YEARS

**4-6 WEEKS**  
**DELIVERY**

max. working pressure 10 bar  
max. working temperature 95 °C  
connections ½"

A full range of made to order sizes available.  
Please ask for details.  
heating element usage available

PRODUCT CODE	Height mm	Width mm	Heat outputs ΔT 50°C Watts Btu	PRICE (ex VAT)
HER 0350180003	1800	350	1315 4487	£ 1322
HER 0445180004	1800	445	1750 5972	£ 1637
HER 0540180005	1800	540	2186 7457	£ 1973

# CALISTA

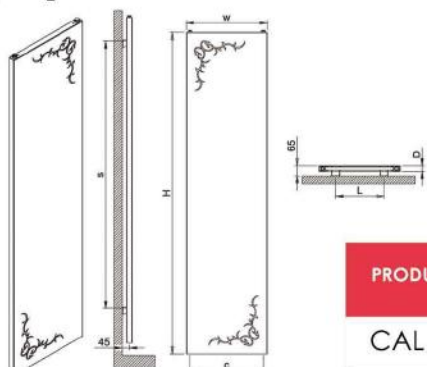

**MATERIAL**  
STAINLESS STEEL

**GUARANTEE**  
20 YEARS

**4-6 WEEKS**  
**DELIVERY**

max. working pressure 10 bar  
max. working temperature 95 °C  
connections ½"

A full range of made to order sizes available.  
Please ask for details.

PRODUCT CODE	Height mm	Width mm	Heat outputs ΔT 50°C Watts Btu	PRICE (ex VAT)
CAL 05001800	1800	500	1062 3623	£ 1185

## BESPOKE ALUMINIUM DESIGNER RADIATORS TECHNICAL SPECIFICATIONS

Aluminium Designer Radiators can be produced in many other variations  
Please ask for different options available...

For Accessories Please check page **158-159**

# ACCESSORIES



MONZA  
with black S type towel holder

MONZA  
with white linear towel holder

# TOWEL HOLDERS



S TYPE  
wall mounted



LINEAR  
wall mounted

## Available models for Towel Holders :

OTTO, GAIA, VESTA, ELVINO, WAVE, NIXIE, D.NEMO, NEMO, D. MONZA, MONZA, ELLIPTIC, PLAY, TALLIS, SOPHIA, STEP, ELITE

## Stainless Steel Towel Holder is available for :

SARP, STRIPE



THS 400 SS

## Optional towel holders & robe hooks available...

Please feel free to order a wall mounted towel holder or robe hooks for any radiator.

PRODUCT CODE	DESCRIPTION	FINISHES	PRICE (ex VAT)
THL 400 W	Towel Holder Linear	TXW textured white	£ 89
THL 400 B	Towel Holder Linear	TXB textured black	£ 89
THL 400 C	Towel Holder Linear	CHR chrome	£ 109
THS 400 W	Towel Holder S type	TXW textured white	£ 99
THS 400 B	Towel Holder S type	TXB textured black	£ 99
THS 400 C	Towel Holder S type	CHR chrome	£ 119
THS 400 SS	Towel Holder Stainless	SS brushed	£ 149

# ROBE HOOKS



PRODUCT CODE	DESCRIPTION	FINISHES	PRICE (ex VAT)
RBHK W	Robe Hooks	TXW textured white	£ 39
RBHK B	Robe Hooks	TXB textured black	£ 39
RBHK C	Robe Hooks	CHR chrome	£ 49

# HEATING ELEMENT



## You can order heating elements;

SLV silver finishes for stainless steel products, CHR chrome finishes for steel products.

## ELEC-HOT thermostatic element with masking cover

300 Watt - 600 Watt - 800 Watt



T PIECE  
for DUAL versions

PRODUCT CODE	DESCRIPTION	FINISHES	PRICE (ex VAT)
ELHOT12C	120 W Heating Element	CHR chrome	£ 159
ELHOT12S	120 W Heating Element	SLV silver	£ 157
ELHOT3C	300 W Heating Element	CHR chrome	£ 159
ELHOT3S	300 W Heating Element	SLV silver	£ 157
ELHOT6C	600 W Heating Element	CHR chrome	£ 159
ELHOT6S	600 W Heating Element	SLV silver	£ 157
ELHOT8C	800 W Heating Element	CHR chrome	£ 159
ELHOT8S	800 W Heating Element	SLV silver	£ 157
TCHR	Tpiece for DUAL options	CHR chrome	£ 23



# INSTALLATION KIT



**ROUND**  
installation kits 200 mm.

PRODUCT CODE	DESCRIPTION	FINISHES	PRICE (ex VAT)
RIK	Round Installation Kit	CHR chrome	£ 29

# VALVES



**MINIMALIST**  
chrome straight valve



**MINIMALIST**  
chrome angled valve

PRODUCT CODE	DESCRIPTION	FINISHES	PRICE (ex VAT)
MINAN	Minimalist Angled Valve	CHR chrome	£ 45
MINAN	Minimalist Angled Valve	SS brushed	£ 45
MINST	Minimalist Straight Valve	CHR chrome	£ 45
MINST	Minimalist Straight Valve	SS brushed	£ 45



**SPERA**  
chrome angled valve



**SPERA**  
chrome straight valve

PRODUCT CODE	DESCRIPTION	FINISHES	PRICE (ex VAT)
SSPRAN	Spera Angled Valve	CHR chrome	£ 25
SPRAN	Spera Angled Valve	SS brushed	£ 25
SPRST	Spera Straight Valve	CHR chrome	£ 25
SPRST	Spera Straight Valve	SS brushed	£ 25



**TRADITIONAL**  
chrome angled valve

PRODUCT CODE	DESCRIPTION	FINISHES	PRICE (ex VAT)
TRAN	Trad. Angled Valve	CHR chrome	£ 45



**THERMO**  
thermostatic angled valve



**THERMO**  
thermostatic straight valve

PRODUCT CODE	DESCRIPTION	FINISHES	PRICE (ex VAT)
THRAN	Thermo. Angled Valve	CHR chrome	£ 45
THRST	Thermo. Straight Valve	CHR chrome	£ 45

carisaradiators.co.uk

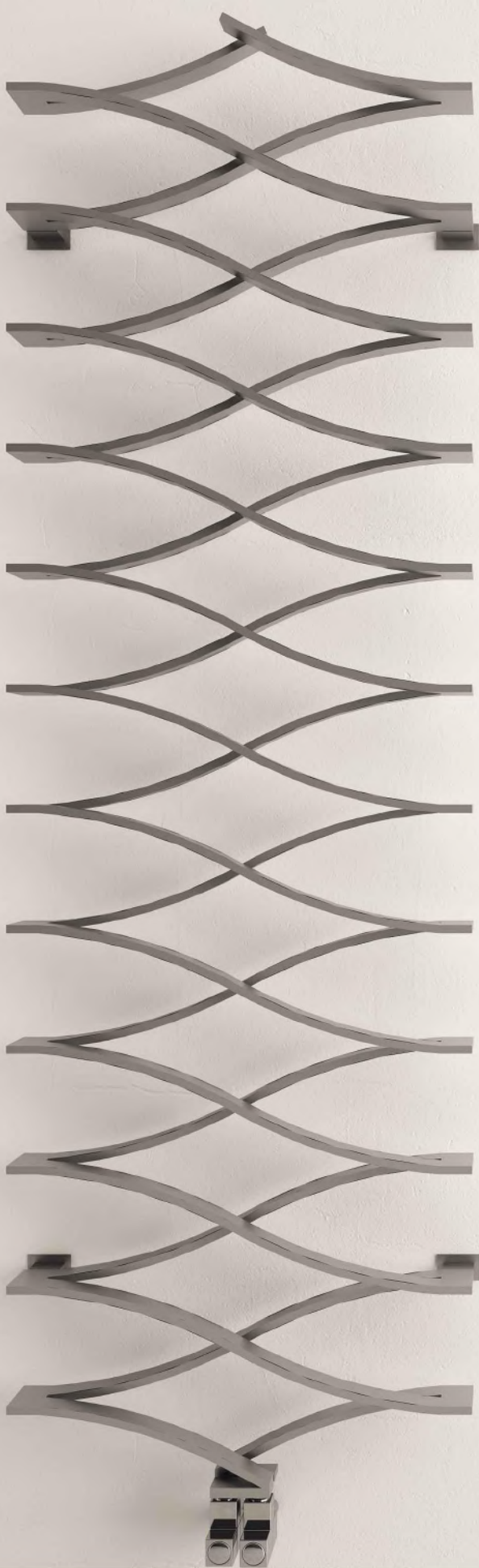

**Carisa Radiators Ltd**

Unit 5 Meridian Park, Neptune Close, Medway City Estate, Rochester KENT, ME2 4LT UNITED KINGDOM  
Phone : 01634 711577- 01634 931633

[enquiries@carisaradiators.co.uk](mailto:enquiries@carisaradiators.co.uk)

© 2018 Carisa Radiators Ltd All Rights Reserved.

We reserve the right to change colours, designs and product specifications or method of manufacture, without prior notice and without incurring any obligation. Due to printing processes and manufacturing tolerances the colour of finished radiators may vary slightly from the colours shown in this catalog.