



MAIN HEATING RANGE GUIDE

Combi and system boilers and cylinders.

At Main, we only offer products and services that are straightforward, effective, efficient – and don't break the bank.

That means a wide range of reliable, easy-to-install, low maintenance boilers, cylinders and water heaters – as well as a range of heating controls that save your customers even more money. On top of all that, Main training and support services are there to offer help when you want it.

It's everything you need.

Our range

Of course, we don't just offer boilers and accessories, we also have a range of unvented hot water cylinders and water heaters to complement them. You'll find all the details you need on all our products in this easy-to-understand brochure – including technical specifications and flue options.

Our service

To make it easier for you to get the job done, we offer FREE training courses and technical support, so you'll always have the very latest Main product knowledge. And because our dedicated training centres are spread across the UK, you'll always be within easy reach, wherever you are.

Although our products are easy to install and simple to maintain, sometimes you just need a bit of help and advice. That's why we also have Baxi Customer Support – our service division with a dedicated service centre and field engineers.

You can reach them on 0344 871 1545.

Our heritage

We've been designing and building boilers in the UK for more than 75 years, working to the highest standards and ensuring the highest quality.

It's given us a proud reputation for excellence in our industry – a reputation that's strengthened with each outstandingly reliable boiler, cylinder or water heater we develop.

It all means that when you install Main, you install a product you can depend on to get the job done.

It all means that when you install Main, you install a product you can depend on to get the job done, with each outstandingly reliable boiler, cylinder or water heater we develop. It's given us a proud reputation for excellence in our industry – a reputation that's strengthened through the highest standards and ensuring the highest quality. We've been designing and building boilers in the UK for more than 75 years, working to the highest

Our heritage

You asked for it...

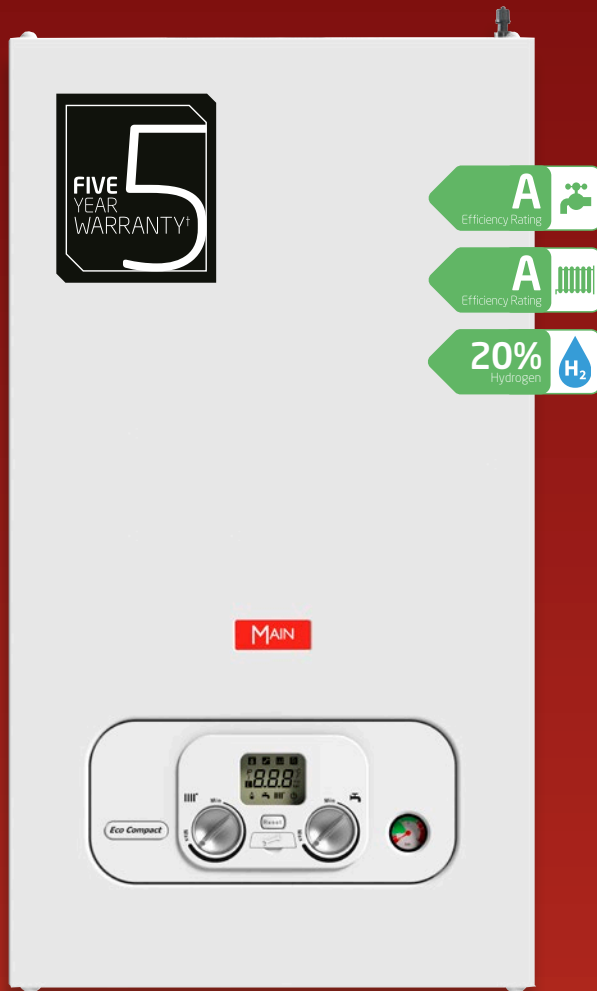

- ✓ 25 and 30kW
- ✓ 29.5kg lift weight
- ✓ Compact cupboard fit
- ✓ Front access to all components
- ✓ Central top flue
- ✓ Brass hydraulics block
- ✓ Optional stand-off frame
- ✓ Certified to work with 20% hydrogen

Key features

5 Year Warranty¹

Outputs 25kW and 30kW

Compact cupboard fit

Lightweight

Front access to all components

Fully modulating and highly efficient

Central top flue

Flueing options of up to 20m

Optional outdoor weather sensor available

Ease of service

Vertical packaging easy to transport and unpack

Clean aesthetic finish

OpenTherm interface

Rigid filling link

Benefits

For peace of mind

To suit most property sizes

Can be installed discreetly

29.5kg lift weight

Saves time when servicing, allowing for ease of maintenance and repair

Boiler intelligently uses the right amount of fuel to meet the set central heating temperatures, saving money on fuel bills

For ease of replacement

Allowing greater flexibility of siting

Enhances system control and customer comfort

No special tools or replacement seals required for standard service

Allows for ease of access to all installation accessories from top of the packaging

Boiler casing hides system connections for cleaner finish

Compatible with Baxi uSense wired thermostat

For a neater finish

Main Eco Compact Combi

We designed the Main Eco Compact Combi after talking to installers across the UK to find out what they want from a combi boiler.

In addition to Main Heating's tried and tested technology, this boiler is cupboard-fit, lightweight, compatible with Baxi uSense wired smart thermostat and has a five year warranty[†].

Compatible accessories



7649277
Baxi uSense wired
smart thermostat



7683084
Baxi IFOS In Flue
Outdoor Sensor Kit



720971601
Baxi wired room
thermostat



720030701
MAIN RF digital
7-day programmable
roomstat



7703233
On wall
outdoor sensor

Technical specifications

Dimensions and minimum clearances

Boiler dimensions

Width [A]	Height [B]	Depth [C]
390mm	700mm	285mm

Service clearances

Side [D]	Upper [E]	Lower [F]	Front [G]
5mm*	178mm*	200mm*	5mm* in operation
*450mm for servicing			

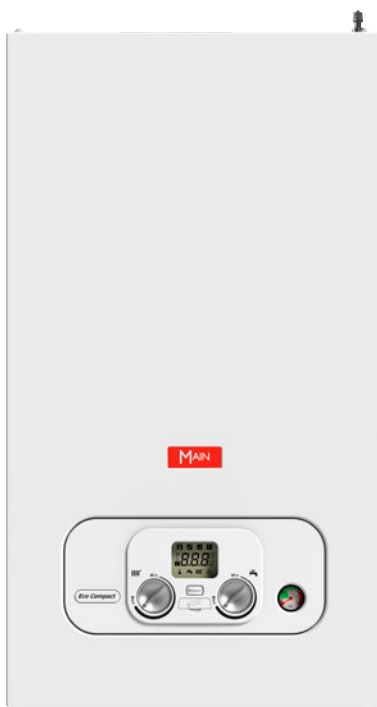

Included with the Main Eco Compact Combi

Wall mounted bracket



Copper pipe tails

Literature and fitting pack

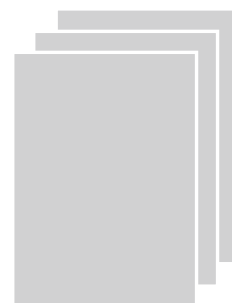

Rigid filling link

Main Eco Compact Combi	Units	Main Eco Compact Combi 25kW	Main Eco Compact Combi 30kW
Sales code (boiler only)		7714519	7714161
Controls and accessories			
Reset button		Yes	Yes
User adjustable DHW temperature		Yes	Yes
User adjustable CH temperature		Yes	Yes
LED temp/status/fault diagnosis display		Yes	Yes
Integral 24hr electro-mechanical timer (optional 720971401)		No	No
Gas			
Natural gas		Yes	Yes
Nominal inlet supply pressure	mbar	20	20
Maximum gas rate	m ³ /h	2.71	3.26
Propane LPG		No	No
Heat input central heating (CH)	kW Max Gross(QnHs) kW Min Gross(QnHs)	22.86 6.87	22.86 6.87
Heat output CH non-condensing	kW Max (Pn) kW min (Pn)	20.00 6.20	20.00 6.20
Heat output CH condensing	kW max (Pnc) kW min (Pnc)	21.16 6.70	21.20 6.70
Heat input domestic hot water	kW Max Gross (QnwHs)	25.77	30.00
Heat output domestic hot water	kW Max (Pn)	25.00	30.93
ErP product information			
NOx	class	6	6
Space heating efficiency class		A	A
Water heating declared load profile		XL	XL
Water heating efficiency class		A	A
Seasonal space heating energy efficiency	%	93	93
Electrical			
Electrical supply	Volts/Hz	230/50	230/50
Permanent live required		Yes	Yes
Fitted electrical cable		No	No
Power consumption	Watts	68	68
External fuse rating	Amps	3	3
Internal fuse rating	Amps	F2AH250V	F2AH250V
Ingress protection rating		IPX5D	IPX5D
Integral 'boiler only' frost thermostat		Yes	Yes
Mechanical			
Stand off frame - optional (7715535)		Yes	Yes
Pre-plumbing/wall mounting jig - optional (7715591)		Yes	Yes
Isolating valves		Yes	Yes
Gas supply connection	mm	22	22
Central heating connections	mm	22	22
Domestic hot water connections	mm	15	15
Condensate drain connection	mm	21.50	21.50
Safety discharge connection	mm	15	15
Safety discharge pressure	bar	3	3
Temporary rigid filling loop included		Yes	Yes
Hydraulic			
Domestic hot water output (raised 35°C) (max)	l/min	10.2	12.2
Domestic hot water operating flow rate (min)	l/min	2*	2*
Domestic hot water operating pressure (min)	bar	0.5	0.5
Domestic hot water system pressure (max)	bar	8	8
CH safety discharge pressure	bar	3	3
Integral automatic bypass		Yes	Yes
Integral expansion vessel capacity	litres	7	7
Max capacity of central heating system	litres	100	100
Compartment ventilation requirement		No	No
CH system inhibitor required		Yes	Yes
24 hour pump exercise		Yes	Yes
Pump overrun		Yes	Yes
Concentric flue systems			
Concentric flue diameters	mm	60/100 and 80/125	
Standard horizontal flue kit length (60/100mm)	mm	685	685
Max equiv length horizontal/vertical (60/100mm)	m	10	10
Max equiv length horizontal/vertical (80/125mm)	m	20	20
Equivalent length per 135° bend	m	0.50	0.50
Equivalent length per 93° bend	m	1.00	1.00
Weights			
Max installation lift weight	kg	29	29
Gross packaged boiler weight	kg	32	32

* Where low flow taps or fittings are intended to be used in the DHW system connected it is strongly recommended that the DHW flow rate DOES NOT fall below 2.5 l/min. This will ensure reliable operation of DHW function

What's inside?

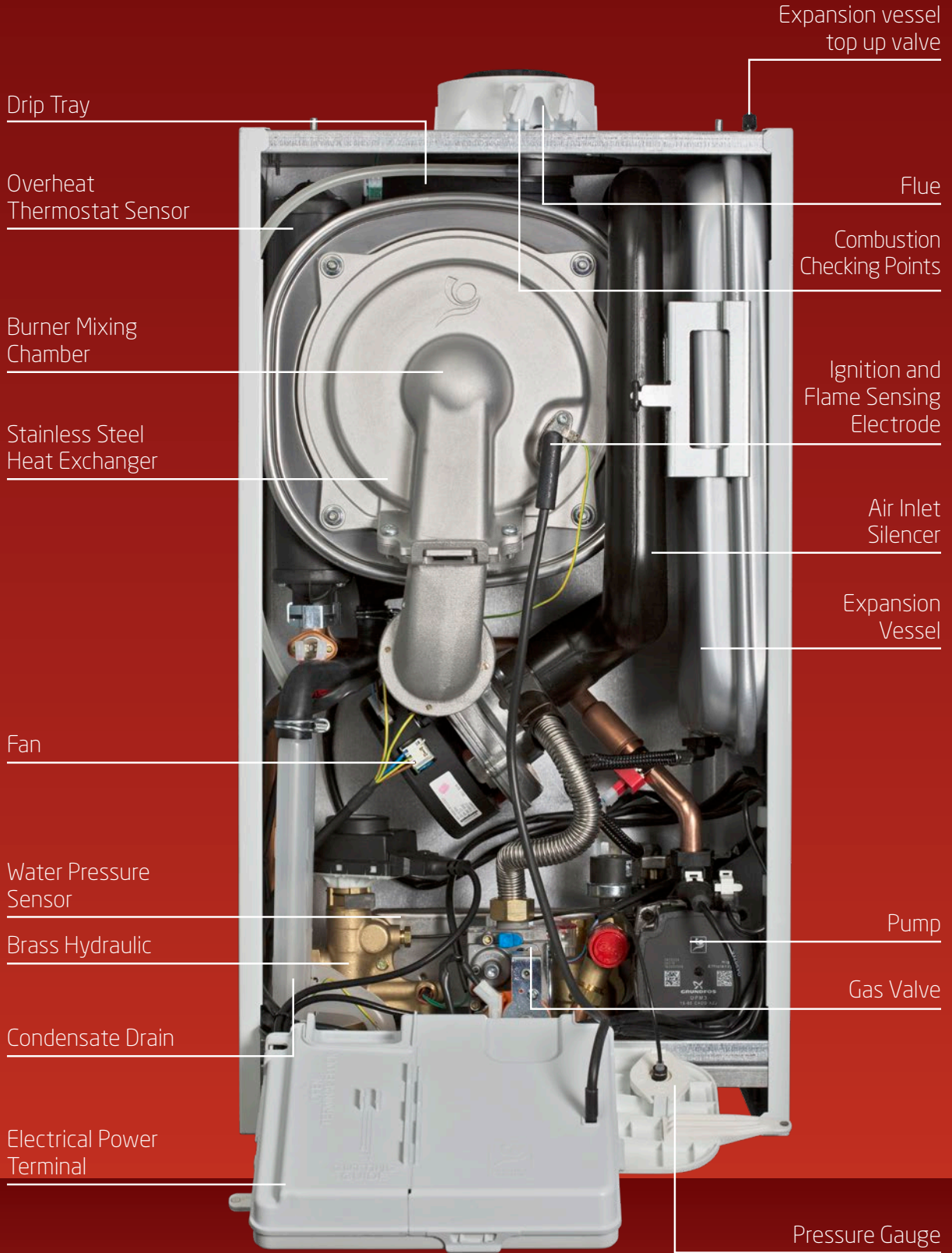

Flue solutions

Horizontal concentric flues Ø 60/100mm

Multifit Flue Group A

Item	Description (multifit) flue system	Colour	Specification	Key and OD dimensions	Sales code
1	Horizontal telescopic flue inc. low profile elbow and fixing screws	White pipe/white terminal	315mm – 500mm	100mm	720599401
2	Horizontal telescopic flue inc. low profile elbow and fixing screws	White pipe/black terminal	315mm – 500mm	100mm	720598701
3	1m flue extension inc. fixing screws	White	1000mm	100mm	720648801
4	93° flue bend inc. fixing screws	White	93°	100mm	720648401
5	135° flue bend inc. fixing screws (pair)	White	135°	100mm	720647901
6	Standard horizontal flue inc. low profile elbow and fixing screws	White pipe/black terminal	685mm	100mm	7222019

Plume displacement kits Ø 60/100mm

Multifit Flue Group A

Item	Description (multifit) flue system	Colour	Specification	Key and OD dimensions	Sales code
7	Plume displacement terminal kit for telescopic flue inc. 1m extension and brackets	White		60mm	720627001
8	Plume displacement terminal kit for telescopic flue inc. 1m extension and brackets	Black		60mm	720622901
9	Plume displacement kit extension and brackets	White	1000mm	60mm	720643401
10	Plume displacement terminal kit inc. 1m extension and brackets	White		60mm	7225717
11	Plume displacement terminal kit inc. 1m extension and brackets	Black		60mm	7225716

Vertical concentric flues Ø 60/100mm

Multifit Flue Group A

Item	Description (multifit) flue system	Colour	Specification	Key and OD dimensions	Sales code
12	Vertical flue terminal	Black		100mm	5118576
3	1m flue extension inc. fixing screws	White	1000mm	100mm	720648801
4	93° flue bend inc. fixing screws	White	93°	100mm	720648401
5	135° flue bend inc. fixing screws (pair)	White	135°	100mm	720647901



You asked for it...

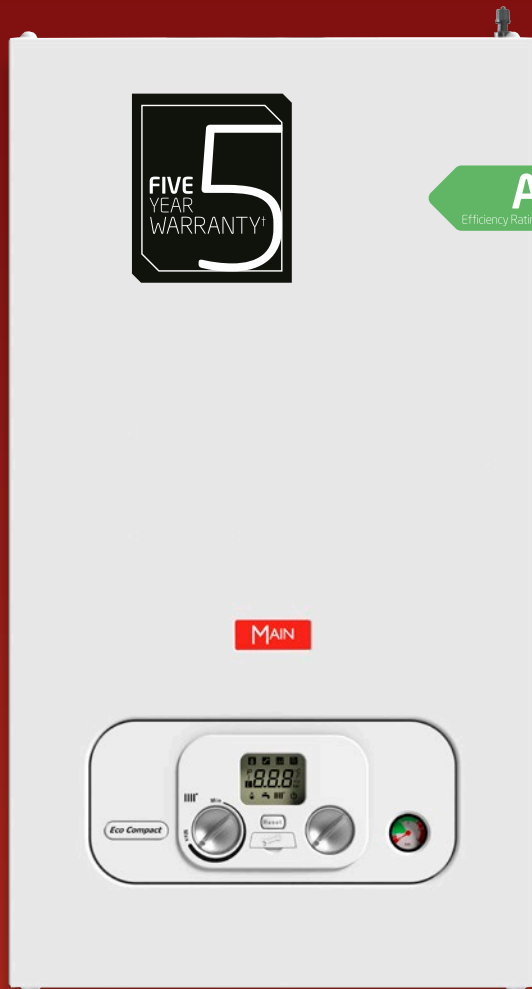

- ✓ 15 and 18kW
- ✓ 28kg lift weight
- ✓ Compact cupboard fit
- ✓ Front access to all components
- ✓ Central top flue
- ✓ Optional stand-off frame

Key features

5 Year Warranty¹

Outputs 15kW and 18kW

Compact cupboard fit

Lightweight

Front access to all components

Fully modulating and highly efficient

Central top flue

Flueing options of up to 20m

Ease of service

Vertical packaging

Clean aesthetic finish

Benefits

For peace of mind

To suit most property sizes

Can be installed discreetly

28kg lift weight

Saves time when servicing, allowing for ease of maintenance and repair

Boiler intelligently uses the right amount of fuel to meet the set central heating temperatures, saving money on fuel bills

For ease of replacement

Allowing greater flexibility of siting

No special tools or replacement seals required for standard service

Easy to transport and unpack

Boiler casing hides system connections for cleaner finish

Main Eco Compact System

The new cupboard fit Main Eco Compact System boiler is the perfect choice for homes with more than one bathroom, to satisfy all its hot water needs.

It is easy to install and service, with front access to all components and central top flue, while its five year warranty, good looks and simple controls make it the perfect choice for householders.

Compatible accessories



720644801
Baxi programmable
7-day wireless sensor
(2 channel)



720971601
Baxi wired room
thermostat

Technical specifications

Dimensions and minimum clearances

Boiler dimensions

Width [A]	Height [B]	Depth [C]
390mm	700mm	285mm

Service clearances

Side [D]	Upper [E]	Lower [F]	Front [G]
5mm*	178mm*	200mm*	5mm*

*450mm for servicing

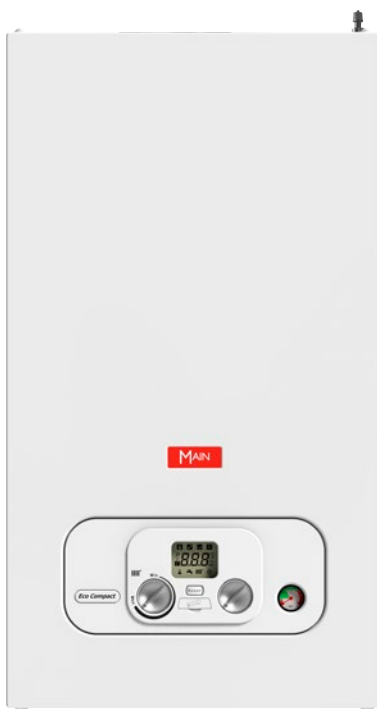

Included with the Main Eco Compact System

Bracket



Literature and fitting pack

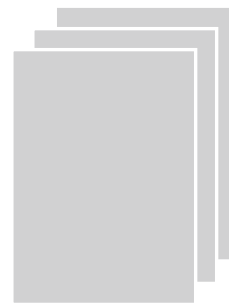

Copper pipe tails



Main Eco Compact System	Units	Main Eco Compact System 15kW	Main Eco Compact System 18kW
Sales code (boiler only)		7714605	7714606
Controls			
Reset switch		Yes	Yes
User adjustable CH temperature		Yes	Yes
LED operating status display		Yes	Yes
Gas			
Natural Gas		Yes	Yes
Nominal inlet supply pressure	mbar	20	20
Maximum gas rate	m ³ /hr	1.64	1.96
Heat input central heating (CH)	kW max gross (QnHs)	17.16	20.60
	kW min gross (QnHs)	5.15	5.15
Heat output CH non-condensing	kW max (Pn)	15.00	18.00
	kW min (Pn)	4.50	4.50
Heat output CH condensing	kW max (Pnc)	16.2	19.4
	kW min (Pnc)	4.9	4.9
ErP product information			
NOx	class	6	6
Sound power level, indoors	L _{WA} dB	49	51
Space heating efficiency class		A	A
Electrical			
Electrical supply	Volts/Hz	230/50	230/50
Permanent live required		Yes	Yes
Switched live		Yes	Yes
Power consumption	Watts	46	56
External fuse rating	Amps	3	3
Internal fuse rating		F2HA250V	F2HA250V
Boiler IP rating (electrical protection)	Approval category	IPX5D	IPX5D
Integral 'boiler only' frost thermostat		Yes	Yes
Pump overrun		Yes	Yes
Mechanical			
Temporary filling loop - optional (248221)			
Wall mounting jig		Yes	Yes
Isolating valves		Yes	Yes
Gas supply connection	mm	22	22
Central heating connections	mm	22	22
Condensate drain connection	mm	21.5	21.5
Safety discharge connection	mm	15	15
Hydraulic			
Safety discharge pressure	bar	3	3
Integral automatic bypass		Yes	Yes
Integral expansion vessel	litres	7	7
Maximum capacity of CH system	litres	100	100
24hr pump exercise		Yes	Yes
Pump overrun		Yes	Yes
Concentric flue systems			
Concentric flue diameter	mm	60/100 and 80/125	
Standard horizontal flue kit length (ø 60/100)	mm	685	685
Maximum equivalent vertical length (ø 60/100)	m	10	10
Maximum equivalent vertical length (ø 80/125)	m	20	20
Equivalent length per 135° bend	m	0.50	0.50
Equivalent length per 93° bend	m	1	1
Weights			
Gross packaged boiler weight	kg	31.2	31.2
Maximum installation lift weight	kg	28.06	28.06

What's inside?

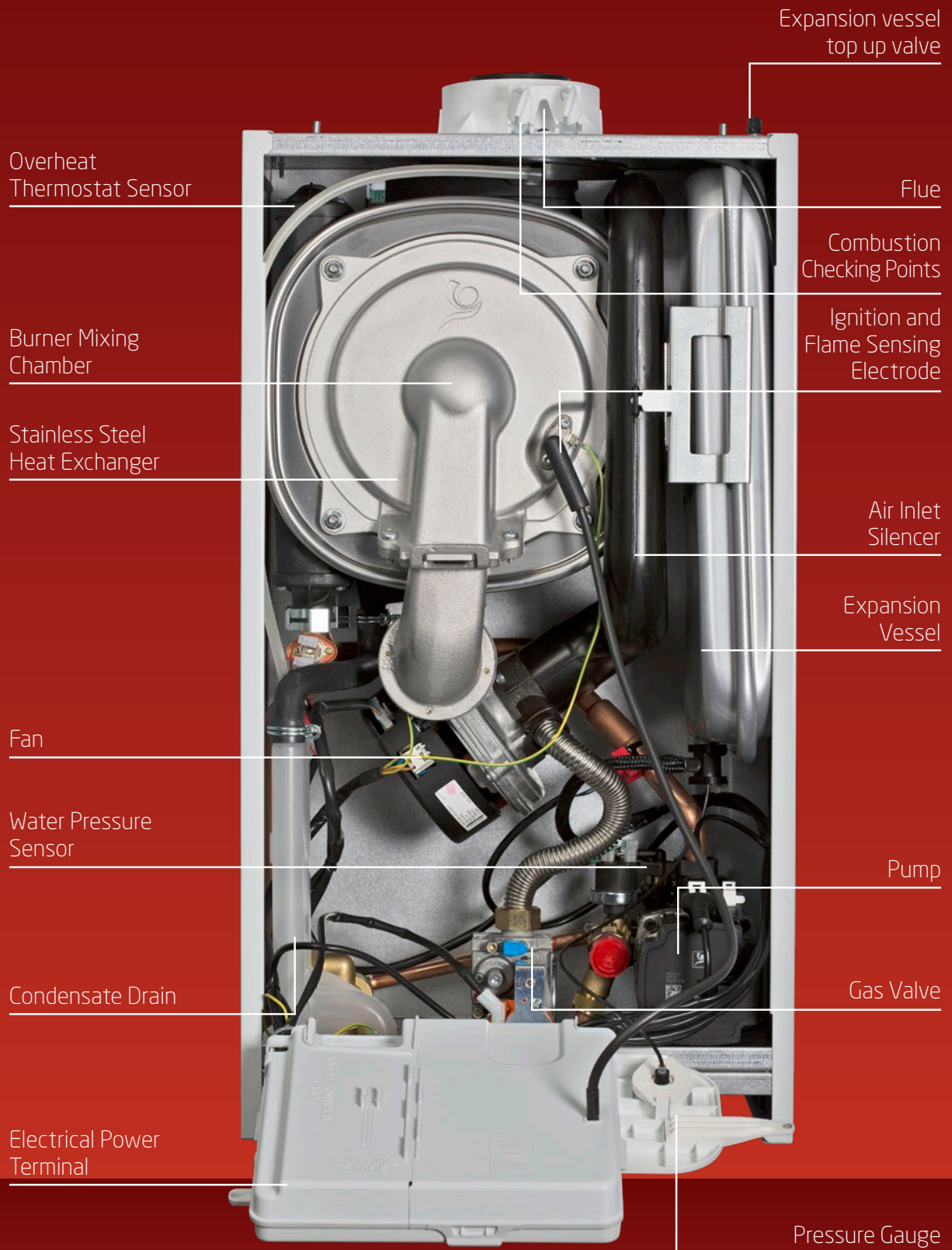

Flue solutions

Horizontal concentric flues Ø 60/100mm

Multifit Flue Group A

Item	Description (multifit) flue system	Colour	Specification	Key and OD dimensions	Sales code
1	Horizontal telescopic flue inc. low profile elbow and fixing screws	White pipe/white terminal	315mm – 500mm	100mm	720599401
2	Horizontal telescopic flue inc. low profile elbow and fixing screws	White pipe/black terminal	315mm – 500mm	100mm	720598701
3	1m flue extension inc. fixing screws	White	1000mm	100mm	720648801
4	93° flue bend inc. fixing screws	White	93°	100mm	720648401
5	135° flue bend inc. fixing screws (pair)	White	135°	100mm	720647901
6	Standard horizontal flue inc. low profile elbow and fixing screws	White pipe/black terminal	685mm	100mm	7222019

Plume displacement kits Ø 60/100mm

Multifit Flue Group A

Item	Description (multifit) flue system	Colour	Specification	Key and OD dimensions	Sales code
7	Plume displacement terminal kit for telescopic flue inc. 1m extension and brackets	White		60mm	720627001
8	Plume displacement terminal kit for telescopic flue inc. 1m extension and brackets	Black		60mm	720622901
9	Plume displacement kit extension and brackets	White	1000mm	60mm	720643401
10	Plume displacement terminal kit inc. 1m extension and brackets	White		60mm	7225717
11	Plume displacement terminal kit inc. 1m extension and brackets	Black		60mm	7225716

Vertical concentric flues Ø 60/100mm

Multifit Flue Group A

Item	Description (multifit) flue system	Colour	Specification	Key and OD dimensions	Sales code
12	Vertical flue terminal	Black		100mm	5118576
3	1m flue extension inc. fixing screws	White	1000mm	100mm	720648801
4	93° flue bend inc. fixing screws	White	93°	100mm	720648401
5	135° flue bend inc. fixing screws (pair)	White	135°	100mm	720647901



You asked for it...



- ✓ 15, 18, 24, 30kW
- ✓ Only 17.4kg*
- ✓ Positive fix wall mounting plate
- ✓ Top central flue
- ✓ No pump overrun
- ✓ No permanent live
- ✓ Front and side access

Key features

- 5 Year Warranty¹
- Outputs 15kW, 18kW, 24kW and 30kW
- Only 17.4kg installer lift weight*
- Compact cupboard fit
- Easy fit wall mounting bracket
- No pump overrun or permanent live required
- Front and side access
- Top central flue
- Industry leading choice of flue lengths, bends and accessories

Benefits

- For peace of mind
- To suit most property sizes
- The lightest boiler available in the UK**
- Can be installed in a 290mm deep cupboard
- Robust with a positive fix and audible lock so you know it's secure
- Saves time and money during installation, and less disruption for the householder
- Servicing is easier and quicker, and no special tools are required
- Easy replacement for existing boilers
- Extensive flue option up to 20 meters for versatile siting and easy replacement

*30kW is 19.5kg installer lift weight
**As at April 2019



Main Eco Compact Heat

The lightweight Main Eco Compact Heat is small enough to fit into a cupboard and is perfect for replacing old, standard efficiency boilers.

Compatible accessories



7212443

Twin channel wired
programmer



720971601

Baxi wired room
thermostat

Technical specifications

Dimensions and minimum clearances

Boiler dimensions

Width [A]	Height [B]	Depth [C]
370mm	625mm	270mm

Service clearances

Side [D]	Upper [E]	Lower [F]	Front [G]
5mm*	190mm*	120mm*	5mm*

*500mm for servicing

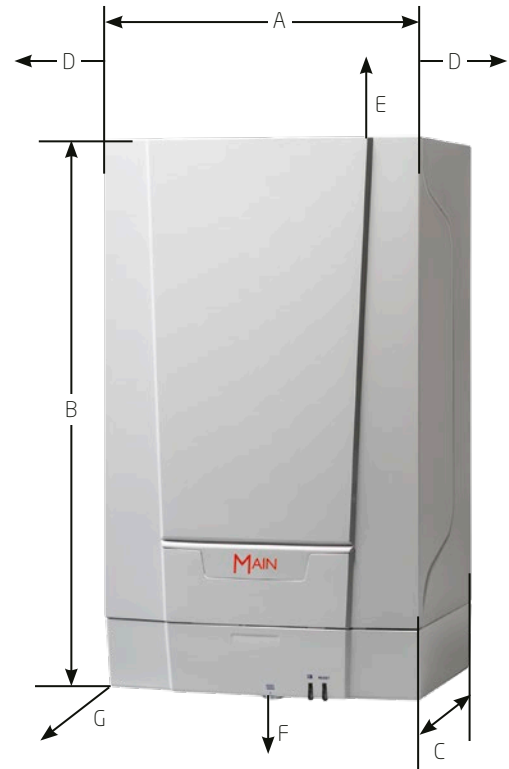

Included with the Main Eco Compact Heat



Bracket



Literature and fitting pack

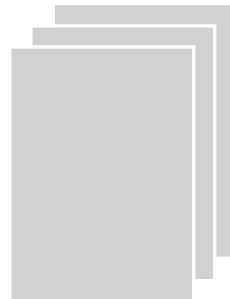

Power lead



Top flue adapter



Copper tail (gas connection) and fibre washer



Main Eco Compact Heat	Units	Main Eco Compact Heat 15kW	Main Eco Compact Heat 18kW	Main Eco Compact Heat 24kW	Main Eco Compact Heat 30kW
Sales code (boiler only)		7712025	7712026	7712028	7712029
Controls and accessories					
Operating mode selector switch with reset		Yes	Yes	Yes	Yes
User adjustable CH temperature	Range 45°C to 82°C	Yes	Yes	Yes	Yes
LED temp/status/ fault diagnosis display		Yes	Yes	Yes	Yes
Twin channel wired programmer	7212443	Optional	Optional	Optional	Optional
Wired room thermostat (optional accessory)	720971601	Optional	Optional	Optional	Optional
Gas					
SAP 2009 Annual Efficiency (PCDB/SEDBUK)	%	89%	89%	89%	89%
NOx class	1-5	5	5	5	5
ErP product information					
NOx	mg/kWh	20	21	24	24
Sound power level, indoors	L _{WA} dB	33	34	37	37
Space heating efficiency class		A	A	A	A
Heat input central heating (CH)	kW max gross (Q _{nHs}) kW min gross (Q _{nHs})	18.32 8.59	21.75 8.59	28.62 8.59	34.35 8.59
Heat output CH (non-condensing)	kW max (P _n) kW min (P _n)	16 7.5	19 7.5	25 7.5	30 7.5
Gas supply pipe size	mm	22	22	22	22
Inlet supply pressure (natural gas)	mbar	20	20	20	20
Maximum gas rate	m ³ /hr	1.75	2.07	2.73	3.27
Mechanical and hydraulic					
Compartment ventilation required		No	No	No	No
Flow/return pipe	mm	22	22	22	22
Condensate discharge pipe connection	mm	21.5	21.5	21.5	21.5
Electrical					
Electrical supply	Volts / Hz	230V / 50Hz	230V / 50Hz	230V / 50Hz	230V / 50Hz
Permanent live required		No	No	No	No
Power consumption	Watts	20	23	33	44
External fuse rating	Amps	3	3	3	3
Internal fuse rating		1.6T	1.6T	1.6T	1.6T
Boiler IP rating (electrical protection)	Approval Category	IPX4D	IPX4D	IPX4D	IPX4D
Pump overrun		No	No	No	No
Concentric flue systems					
Standard telescopic concentric flue	mm	315-500	315-500	315-500	315-500
Horizontal concentric (60/100mm)					
	Max equivalent length (m)	6	6	6	6
	Reduction Per 135° bend (m)	0.5	0.5	0.5	0.5
	Reduction Per 93° bend (m)	1	1	1	1
Horizontal concentric (80/125mm)	m	12	12	12	12
Weights					
Gross packaged boiler weight	(Max)kg	19.5	19.5	19.5	21.5
Maximum installation lift weight	kg	17.4	17.4	17.4	19.5

What's inside?

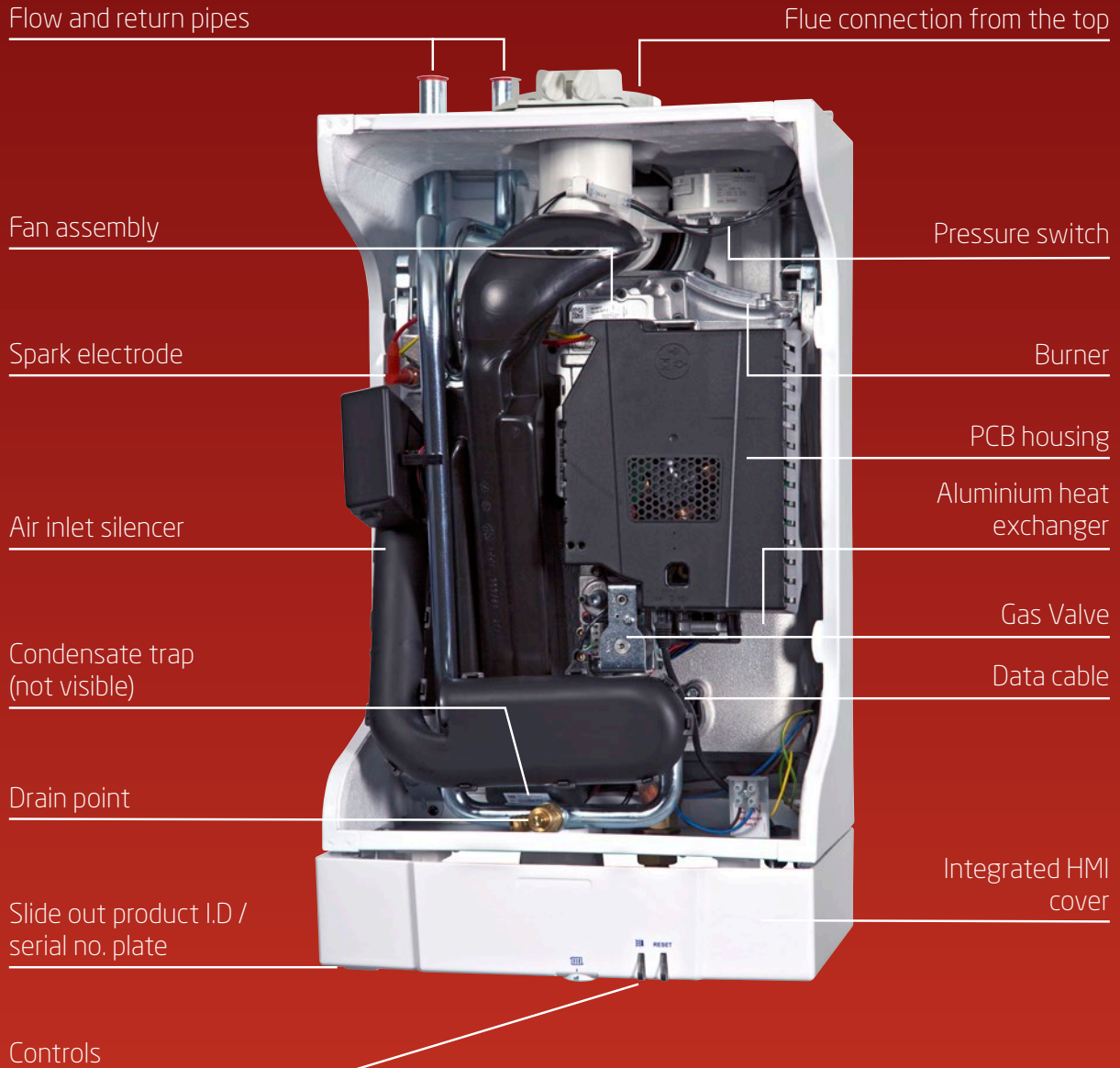

Controls

Slide out product I.D /
serial no. plate

Drain point

Integrated
HMI cover

Flue solutions

Horizontal concentric flues Ø 60/100mm

Multifit Flue Group A

Item	Description (multifit) flue system	Colour	Specification	Key and OD dimensions	Sales code
1	Horizontal telescopic flue inc. low profile elbow and fixing screws	White pipe/white terminal	315mm – 500mm	100mm	720599401
2	Horizontal telescopic flue inc. low profile elbow and fixing screws	White pipe/black terminal	315mm – 500mm	100mm	720598701
3	1m flue extension inc. fixing screws	White	1000mm	100mm	720648801
4	93° flue bend inc. fixing screws	White	93°	100mm	720648401
5	135° flue bend inc. fixing screws (pair)	White	135°	100mm	720647901
6	Standard horizontal flue inc. low profile elbow and fixing screws	White pipe/black terminal	685mm	100mm	7222019

Plume displacement kits Ø 60/100mm

Multifit Flue Group A

Item	Description (multifit) flue system	Colour	Specification	Key and OD dimensions	Sales code
7	Plume displacement terminal kit for telescopic flue inc. 1m extension and brackets	White		60mm	720627001
8	Plume displacement terminal kit for telescopic flue inc. 1m extension and brackets	Black		60mm	720622901
9	Plume displacement kit extension and brackets	White	1000mm	60mm	720643401
10	Plume displacement terminal kit inc. 1m extension and brackets	White		60mm	7225717
11	Plume displacement terminal kit inc. 1m extension and brackets	Black		60mm	7225716

Vertical concentric flues Ø 60/100mm

Multifit Flue Group A

Item	Description (multifit) flue system	Colour	Specification	Key and OD dimensions	Sales code
12	Vertical flue terminal	Black		100mm	5118576
3	1m flue extension inc. fixing screws	White	1000mm	100mm	720648801
4	93° flue bend inc. fixing screws	White	93°	100mm	720648401
5	135° flue bend inc. fixing screws (pair)	White	135°	100mm	720647901



Flue solutions

Multifit flue kits now come with positive screw fixings for all connections and are available in a choice of lengths to reduce the need for onsite cutting. By popular demand we offer a choice of colours for the terminals to match existing rainwater systems.

The options shown are only compatible with Main Heating Eco Elite Combi and System.

Maximum recommended flue lengths

Main Combi / System	A (60/100 Concentric)	G (80/125 Concentric)
Horizontal	10	20
Vertical	10	20

Horizontal concentric flues Ø 60/100mm

Multifit Flue Group A

Item	Description (multifit) flue system	Colour	Specification	Key and OD dimensions	Sales code
1	Horizontal telescopic flue inc. low profile elbow and fixing screws	White pipe/ white terminal	315mm – 500mm	60/100mm	720599401
2	Horizontal telescopic flue inc. low profile elbow and fixing screws	White pipe/ black terminal	315mm – 500mm	60/100mm	720598701
3	Horizontal telescopic flue inc. low profile elbow and fixing screws	White pipe/ brown terminal	315mm – 500mm	60/100mm	720642701
4	Standard horizontal flue inc. low profile elbow and fixing screws*	White pipe/ black terminal	685mm	100mm	7222019
6	Flue terminal deflector	White		60mm	720644201
7	Flue terminal deflector	Black		60mm	5111068
8	Flue terminal deflector	Brown		60mm	720644301
9	1m flue extension inc. fixing screws	White	1000mm	100mm	720648801
10	0.5m flue extension inc. fixing screws	White	500mm	100mm	720643001
11	0.25m flue extension inc. fixing screws	White	250mm	100mm	720643101
12	93° flue bend inc. fixing screws	White	93°	100mm	720648401
13	135° flue bend inc. fixing screws	White	135°	100mm	720648501
14	135° flue bend inc. fixing screws (pair)	White	135°	100mm	720647901
17	Stainless steel terminal guard – Ø 60/100	S/S	Stainless steel	100mm	720627901

Plume displacement kits Ø 60/100mm

Multifit Flue Group A

Item	Description (multifit) flue system	Colour	Specification	Key and OD dimensions	Sales code
18	Plume displacement terminal kit inc. 1m extension and brackets	White		60mm	720627001
19	Plume displacement kit extension and brackets	White	1000mm	60mm	720643401
20	Plume displacement kit bend	White	93°	60mm	5121369
21	Plume displacement kit bend – pair	White	135°	60mm	5121370
22	Plume displacement terminal kit inc. 1m extension and brackets	Black		60mm	720622901
23	Plume displacement kit extension and brackets	Black	1000mm	60mm	720643301
24	Plume displacement kit bend	Black	93°	60mm	720648701
25	Plume displacement kit bend – pair	Black	135°	60mm	720648601
26	Plume displacement terminal kit inc. 1m extension and brackets	White		100mm	7225717
27	Plume displacement terminal kit inc. 1m extension and brackets	Black		100mm	7225716
28	Under balcony eaves flue kit	White	135°	60mm	7211039
29	Under balcony eaves flue kit	Black	135°	60mm	7211041

Vertical concentric flues Ø 60/100mm

Multifit Flue Group A

Item	Description (multifit) flue system	Colour	Specification	Key and OD dimensions	Sales code
30	Vertical ridge flue terminal	Brown		100mm	720647101
31	Vertical flue terminal	Black		100mm	5118576
32	Roof cover plate			125mm	246143
9	1m flue extension inc. fixing screws	White	1000mm	100mm	720648801
10	0.5m flue extension inc. fixing screws	White	500mm	100mm	720643001
11	0.25m flue extension inc. fixing screws	White	250mm	100mm	720643101
12	93° flue bend inc. fixing screws	White	93°	100mm	720648401
13	135° flue bend inc. fixing screws	White	135°	100mm	720648501
14	135° flue bend (pair) inc. fixing screws	White	135°	100mm	720647901
33	Pitched roof flashing		25°/50°	125mm	5122151
34	Flat roof flashing			125mm	246144



Flue solutions

Horizontal concentric flues Ø 80/125mm

Multifit Flue Group G

Item	Description (multifit) flue system	Colour	Specification	Key and OD dimensions	Sales code
35	Horizontal flue inc. boiler and terminal adaptors	Black		125mm	5118580
36	1m flue extension	White	1000mm	125mm	5118584
37	Flue bend	White	91.5°	125mm	5118588
38	Flue bend (pair)	White	135°	125mm	5118597
39	Pipe support bracket	White	125mm flue pipes	125mm	5118610

Vertical concentric flues Ø 80/125mm

Multifit Flue Group G

Item	Description (multifit) flue system	Colour	Specification	Key and OD dimensions	Sales code
40	Vertical flue terminal	Black		125mm	5111078
36	1m flue extension	White	1000mm	125mm	5118584
37	Flue bend	White	91.5°	125mm	5118588
38	Flue bend (pair)	White	135°	125mm	5118597
41	Flue vertical adaptor	White		100/125mm	5111070
33	Pitched roof flashing		25°/55°	125mm	5122151
35	Flat roof flashing			125mm	246144
39	Pipe support brackets	White	125mm flue pipes	125mm	5118610



Terminal position with minimum distance

	(mm)
A ¹ Directly below an opening, air brick, opening windows etc	300
B ¹ Above an opening, air brick, opening window etc	300
C ¹ Horizontally to an opening, air brick, opening window etc	300
D ² Below gutters, soil pipes or drain pipes	25
E ² Below eaves	25
F ² Below balconies or car port roof	25
G ² From a vertical drain pipe or soil pipe	25
H ² From an internal or external corner	25
I Above ground, roof or balcony level	300
J From a surface or boundary line facing a terminal	600
K From a terminal facing a terminal (Horizontal flue)	1200
K From a terminal facing a terminal (Vertical flue)	600
L From an opening in a carport (e.g. door, window) into the dwelling	1200
M Vertically from a terminal on the same wall	1500
N Horizontally from a terminal on the same wall	300
R From adjacent wall to flue (vertical only)	300
S From an adjacent opening window (vertical only)	300
T Adjacent to windows or openings on pitched and flat roofs	600
U Below windows or openings on pitched roofs	2000

- In addition, the terminal should be no nearer than 150mm to an opening in the building fabric formed for the purpose of accommodating a built-in element such as a window frame.
- Only ONE 25mm clearance is allowed per installation. If one of the dimensions D, E, F, G or H is 25mm then the remainder MUST be as B.S.5440-1.

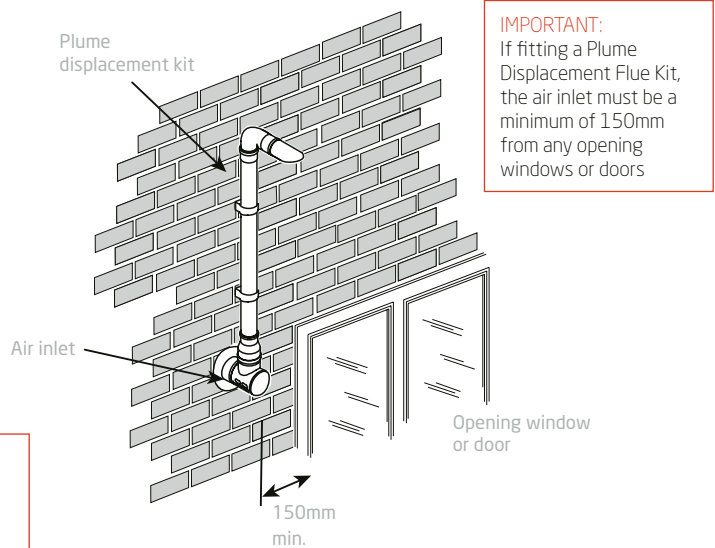
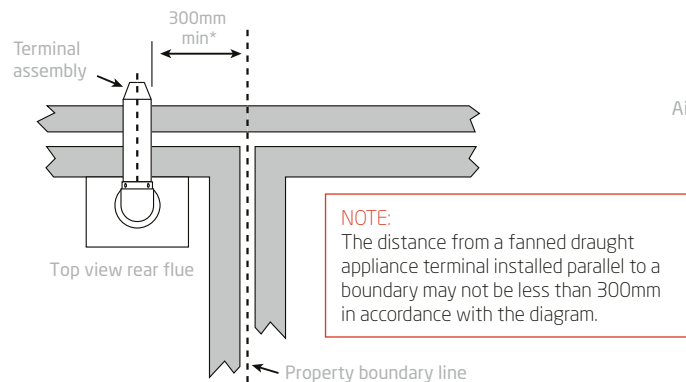
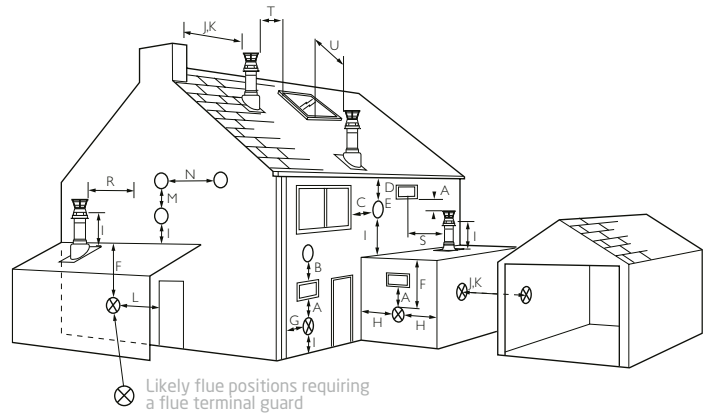

* This can be reduced to 25mm by using item 6/7/8 flue deflector.

B
Efficiency Rating



Key features

One year parts and labour warranty plus 25 year warranty on stainless steel inner vessel¹

120, 150, 170, 210, 250 and 300 litre capacity - direct and indirect types

Indirect heating coil is factory fitted with an electric immersion heater as back up

Coil in coil heat exchanger

Incoloy 800 alloy sheathed elements

KIWA approved

50mm of polyurethane foam insulation

Benefits

For peace of mind

A cylinder for every style and size of property, to meet all hot water demands

Hot water whenever it is needed

Ensures rapid, energy efficient heat recovery

Designed to resist corrosion

Complies with water regulations and Building Regulation G3

Minimum heat loss and maximum efficiency

Main Unvented Cylinder

Manufactured in the UK, the Main Unvented Hot Water Cylinder is easy to install, with front access to controls and connections. The coil-in-coil heat exchanger ensures rapid heat recovery and 50mm of factory injected polyurethane foam ensures that heat loss and running costs are kept to a minimum. The inner cylinder is made from high grade stainless steel for a long product life with low maintenance.

The Main Cylinder, together with a Main Eco Compact System boiler or Main Eco Elite System boiler, provides a complete solution for homes with a high demand for hot water.

Technical specifications

Dimensions and minimum clearances

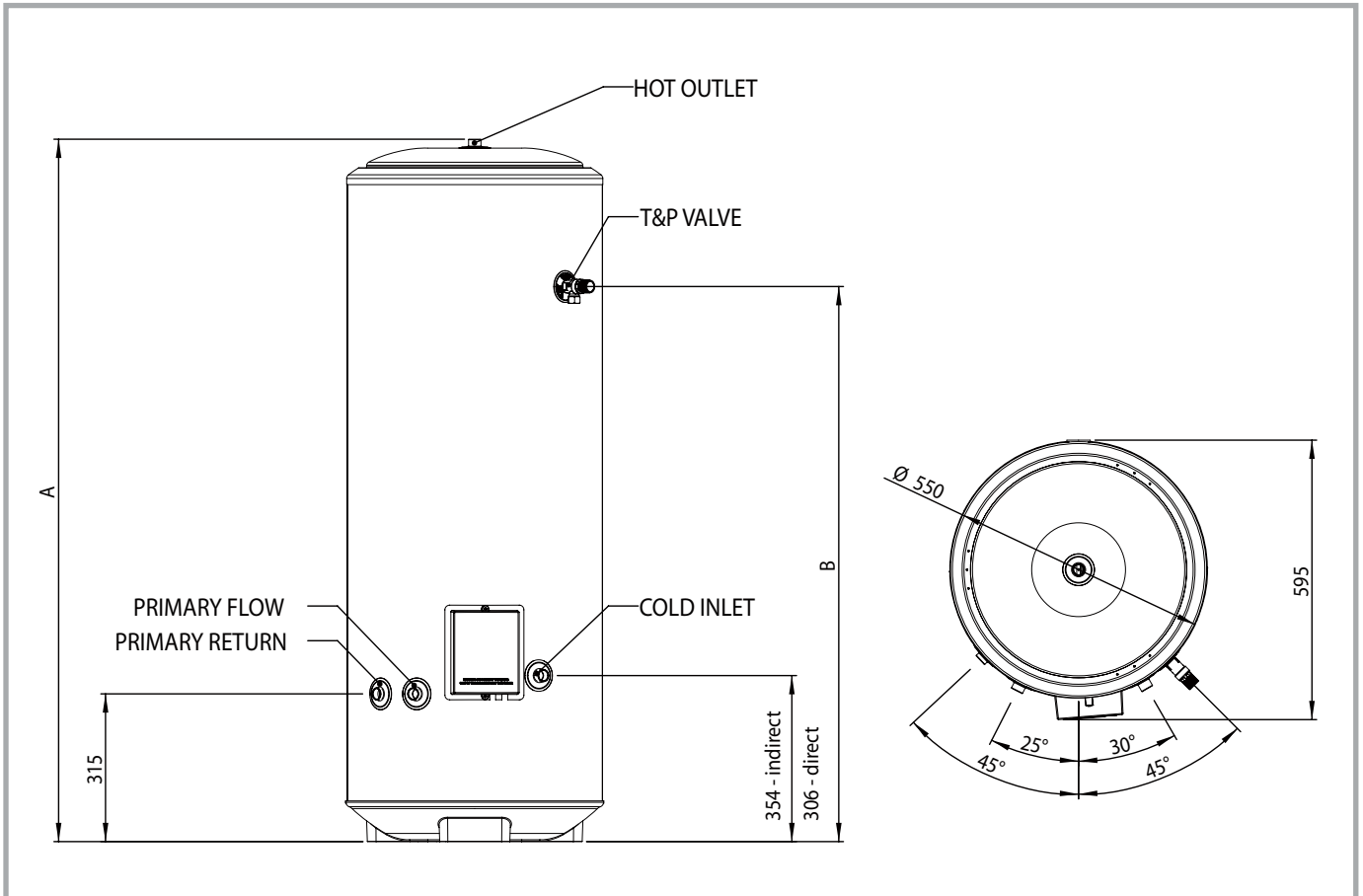

Nominal Capacity (litres)	Type		Dimensions A (mm)	Dimensions B (mm)	kW Rating	Coil Heat Up Time (mins)	Recovery Times	Heating Time Direct (mins)	ErP Rating	Product Code	Standing Heat Loss (kW/h per 24hr)
	Direct	Indirect									
120	✓		931	616				121	C	720635901	1.47
120		✓	931	616	12.5	27	23	29	B	5133561	
150	✓		1114	800				152	C	720636001	1.7
150		✓	1114	800	12.5	38	24	37	C	5133562	
170	✓		1241	927				173	C	720636101	1.92
170		✓	1241	927	16	33	25	35	C	5133563	
210	✓		1499	1184				215	C	720636201	2.3
210		✓	1499	1184	16	41	29	43	C	5133564	
250	✓		1752	1437				260	D	720636301	2.22
250		✓	1752	1379	18	40	30	43	D	5135327	
300	✓		2065	1751				315	D	720636401	2.52
300		✓	2065	1694	19	47	35	49	D	5135328	

Installation

Main unvented cylinders must be installed by a competent installer in accordance with local regulations:

England and Wales – Building regulation G3.

Scotland – Technical standards P3.

N. Ireland – Building regulation P5.

Fixing – Feet on bottom moulding for floor mounting.

Plumbing connections – Inlet/Outlet, 22mm compression fittings / ¾" BSP parallel thread.

Primary coil – 22mm compression fittings / ¾" BSP parallel thread.

Temperature and pressure relief valve – 15mm compression outlet.

Cold water control – Integrated cold water control set comprising pressure reducing valve and strainer – factory set at 3.5 bar, expansion relief valve – factory set at 6 bar and check valve. 22mm compression fittings.

Mains pressure – Min 1.5 bar, Max 16 bar. A 2-port motorised valve is supplied with indirect models.

Flow rates – Up to 55 litres per minute @ 6 bar pressure.

Operating pressure – 3.5 bar.

Expansion relief valve pressure – 6.0 bar.

Operating temperature – Recommended 60°C. Adjustable 10-70°C.

Water expansion – Remote expansion vessel
12 litre vessel supplied with 120 and 150 litre models.
18 litre vessel supplied with 170 and 210 litre models.
24 litre vessel supplied with 250 and 300 litre models.

Minimum water supply requirements – Recommended minimum supply pressure – 1.5 bar/20 l/min flow rate.

If there are any doubts about water supply pressure or flow rates, please contact our Specification Advice Team to discuss on 0845 026 4620.

Secondary circulation – Via 22 x 22 x 15mm swept tee, which should be fitted to the inlet pipework. Secondary Circulation is not recommended for direct units being used with off-peak electricity tariffs.

Pressure testing – Units are tested to 15 bar.

Tundish – 15mm compression inlet and 22mm compression outlet.

Electrical

Indirect models – Controls should be wired to the boiler, programmer etc., in accordance with the control scheme being used.

Direct models – Connection is direct to terminals in the immersion heater which must be permanently connected to the supply through a double-pole lined isolating switch with a minimum breaking capacity of 13A.

All electrical wiring must conform to the latest IEE Wiring Regulations.

Element

Long-life removable Incoloy 800 sheathed element, rated 3.0kW @ 240V. Direct models are fitted with two 3.0kW immersion heaters as standard.

Outer casing

A combination of resilient thermoplastic mouldings and plastic coated corrosion proofed steel sheet.

Thermal insulation

CFC/HCFC free (ODP ZERO)
fire retardant expanded polyurethane. 50mm thickness.

Inner container

High grade stainless steel,
pressure tested to 15 bar.

Primary coil

22mm diameter stainless steel. Coil-in-coil design for improved performance.

Thermostat

Element thermostat adjustable from 10°C to 70°C.

Safety features

Temperature and pressure relief valve, factory set to operate at 10 bar and 90°C. High limit thermostat, factory set at 80°C. Direct models – Manually re-settable cut-out on heating element operates at 80°C.

Indirect models

Must be wired in series with the supplied two-port motorised valve to provide primary over temperature protection.

Anode

None required.

Approvals

KIWA approved for water regulations and building regulation G3. Manufactured in the UK in a BS EN ISO 9001:2008 registered factory. CE marked for compliance with LVD, EMC and pressure equipment directives.

Controls and accessories

The range of Main Eco Compact controls that can be fitted quickly and simply.



720971601
Baxi wired room thermostat



7212444
Baxi single channel wired programmer



7212438
Baxi single channel wired programmable thermostat



720030701
MAIN RF digital 7-day programmable roomstat



720644801
BAXI programmable 7-day wireless sensor (2 channel) (twin channel programmer for system)



7649277
Baxi uSense wired smart thermostat



7683084
Baxi IFOS In Flue Outdoor Sensor Kit



7703233
On wall outdoor sensor



7715591
Main Eco Compact pre-plumb jig



248221
Multifit filling loop



7665482
Multifit Easy-Fill

How we can help



Baxi Customer Support

- Team of experts with products at hand to support installation, service and repair
- Further technical support and how-to videos available at baxi.co.uk

Call us on **0344 871 1525**



Baxi Genuine Parts

- Approved parts for Baxi products
- Guaranteed quality, safety and reliability
- Nationwide network of approved stockists
- Lifetime support for Baxi products
- Range of heating essentials available

Call our knowledgeable and helpful team on **0344 871 1540**
or visit www.baxi.co.uk/trade/boilers-parts-and-accessories/parts
to identify parts and find your nearest stockist



Training

- Practical, hands on training
- Free of charge product training
- A range of specialist courses
- Expert trainers, all accredited, former heating engineers
- Training centres across the UK

Visit baxi.co.uk/training or call **0344 335 4207**

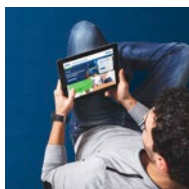

Baxi Works

Sign up to **Baxi Works**, Baxi's online loyalty scheme for installers. Benefits include:

- Same or next day engineer call out from Baxi Customer Support*
- Free Gas Safe notification and easy warranty registration
- Scan your barcodes using the Baxi Toolbelt App
- Free annual service reminders sent to your customers on your behalf
- Free listing on baxi.co.uk to receive homeowner leads
- Earn points for every boiler you register

Visit baxiworks.co.uk to find out more



Events

Visit Baxi Area Sales Managers at your local merchant for an opportunity to get your hands on the latest Baxi boilers and discuss developments in the heating industry.

For more information visit baxievents.co.uk



Literature

You can order all the literature you need for you and your customers, including:

- Range guides
- Product brochures for consumers
- Installation instructions
- User guides
- Instructions for discontinued products

Call the Baxi literature hotline on **0344 871 1525** or contact your local Baxi Area Sales Manager.

All our literature can be downloaded from our website baxi.co.uk

* Full Baxi Works terms and conditions apply.

 0344 871 1525

Opening hours

Monday – Friday, 8am – 6pm

Weekends and Bank Holidays, 8.30am – 2pm

We are open 365 days a year.

Please note calls may be monitored or recorded.

 mainheating.co.uk

 info@mainheating.co.uk

 Main Heating
Brooks House
Coventry Road
Warwick CV34 4LL

Follow us



This brochure is printed on paper sourced from well managed forests and other controlled sources, using vegetable based inks. Please recycle this brochure when you have finished with it.

Baxi policy is one of continual improvement and development. The right to change specification and appearance without prior notice is reserved. The reproduction of colours is as accurate as photographic and printing processes allow. The consumer's statutory rights are not affected. E&OE

MainHeatingRangeGuideOct22

Part of

BAXI

BAXI

remeha

megaflo

**ANDREWS
WATER HEATERS**

HEATRAESADIA

**MAIN
HEATING**

**POTTERTON
COMMERCIAL**

Residential and
commercial heating
and hot water solutions