



OPERATING INSTRUCTIONS

MSZ-G09SV
MSZ-G12SV



OPERATING INSTRUCTIONS

For customers

- To use this unit correctly and safely, be sure to read this operating instructions before use.

Bedienungsanleitung

Für Kunden

- Um diese Einheit richtig und sicher zu verwenden, unbedingt diese Bedienungsanleitung vor der Inbetriebnahme durchlesen.

NOTICE D'UTILISATION

A l'attention des clients

- Pour avoir la certitude d'utiliser cet appareil correctement et en toute sécurité, veuillez lire attentivement cette notice d'instructions avant de mettre l'appareil en fonction.

GEBRUIKSAANWIJZING

Voor de klant

- Om dit apparaat op de juiste manier en veilig te gebruiken, dient u eerst deze gebruiksaanwijzing aandachtig door te lezen.

MANUAL DE INSTRUCCIONES

Para los clientes

- Para emplear correctamente este aparato y por razones de seguridad debe leer este manual de instrucciones de manejo antes de su utilización.

LIBRETTO D'ISTRUZIONI

Per gli utenti

- Per utilizzare correttamente quest'unità, leggere questo libretto d'istruzioni attentamente e per intero.

ΟΔΗΓΙΕΣ ΛΕΙΤΟΥΡΓΙΑΣ

Για τον πελάτη

- Για να χρησιμοποιήσετε αυτή την μονάδα σωστά και με ασφάλεια, βεβαιωθείτε ότι έχετε διαβάσει αυτό το εγχειρίδιο οδηγιών πριν από την χρήση.

INSTRUÇÕES DE OPERAÇÃO

Para os clientes

- Para utilizar esta unidade correctamente, certifique-se de que lê estas instruções de operação antes da utilização.

BRUGSANVISNING

Til kunden

- Læs denne brugsanvisning før brugen så korrekt og forsvarlig anvendelse af klimaanlægget sikres.

BRUKSANVISNING

För kunder

- För att använda enheten på rätt och säkert sätt ska denna bruksanvisning läsas innan enheten tas i bruk.

İŞLETME TALİMATLARI

Satın alıcılar için

- Bu birimi doğru ve güvenli olarak çalıştırmak için, kullanmadan önce bu işletme talimatlarını mutlaka okuyun.

РУКОВОДСТВО ПО ЭКСПЛУАТАЦИИ

Для пользователей

- Для обеспечения правильного и безопасного использования прибора следует до начала его эксплуатации внимательно прочитать данное руководство.

English

Deutsch

Français

Nederlands

Español

Italiano

Ελληνικά

Português

Dansk

Svenska

Türkçe

Русский



CONTENTS

SAFETY PRECAUTIONS	2
NAME OF EACH PART	5
PREPARATION BEFORE OPERATION	7
I FEEL... AUTO OPERATION	8
MANUAL OPERATION (COOL, DRY, HEAT)	9
AIR FLOW VELOCITY AND DIRECTION ADJUSTMENT	10
ECONO COOL OPERATION	11
SWING OPERATION	11
TIMER OPERATION (ON/OFF TIMER)	12
WHEN THE AIR CONDITIONER IS NOT GOING TO BE USED FOR A LONG TIME	12
MAINTENANCE	13
CLEANING THE AIR FILTER AND THE DEODORIZING FILTER	13
REPLACEMENT OF THE DEODORIZING FILTER/ AIR CLEANING FILTER	14
BEFORE CONTACTING THE SERVICE REPRESENTATIVE, CHECK THE FOLLOWING AGAIN	14
WHEN YOU THINK THAT TROUBLE HAS OCCURRED	15
INSTALLATION, RELOCATION AND INSPECTION	16
SPECIFICATIONS	16



SAFETY PRECAUTIONS

- Since rotating parts and parts which could cause an electric shock are used in this product, be sure to read these "Safety Precautions" before use.
- Since the cautionary items shown here are important for safety, be sure to observe them. Marks and their meanings are as shown below.

 WARNING	Incorrect handling could cause a serious hazard, such as death, serious injury, etc. with a high probability.
 CAUTION	Incorrect handling could cause a serious hazard depending on the conditions.

Meanings of symbols used in this manual are as shown below.

	Be sure not to do.
	Be sure to follow the instruction.
	Never insert your finger or stick, etc.
	Never step onto the indoor/outdoor unit and do not put anything on them.
	Danger of electric shock, be careful.
	Be sure to disconnect the power supply plug from the power outlet.
	Be sure to shut off the power.

- After reading this manual, keep it together with the installation manual in a handy place for easy reference.

Warning mark positions and safety devices

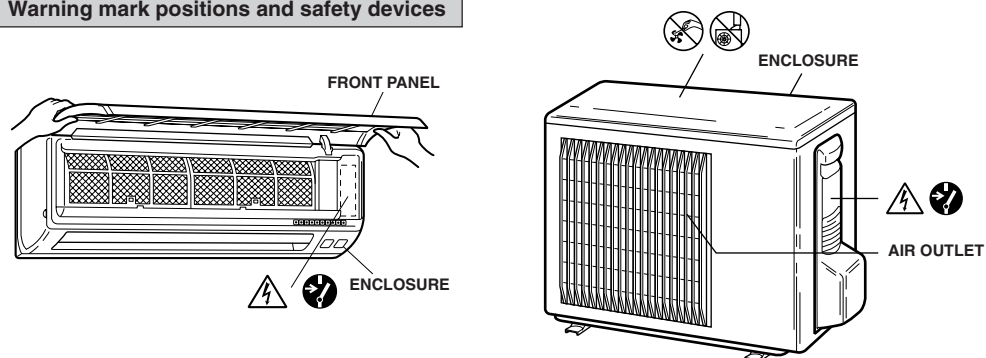



SAFETY PRECAUTIONS

⚠ WARNING

- This air conditioner is NOT intended for use by children or infirm persons without supervisions.

Do not use intermediate connection of the power supply cord or the extension cord and do not connect many devices to one AC outlet.

- A fire or an electric shock may result from poor contact, poor insulation, exceeding the permissible current, etc.



Do not scratch or process the power supply cord, etc.

- Do not put heavy object on the power supply cord and do not scratch or process the cord. The cord may be damaged and this may cause a fire or an electric shock.

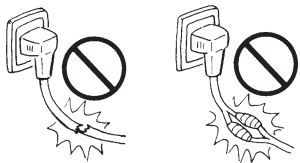

Do not turn the breaker off/on or disconnect/connect the power supply plug during operation.

- This may cause a fire due to spark, etc.
- Be sure to turn off the breaker or disconnect the power supply plug absolutely after switching the indoor unit off with the remote controller.

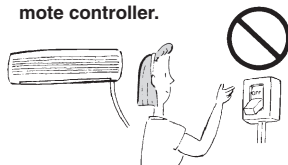

Do not expose your skin directly to cool air for a long time.

- This could damage your health.



When an abnormality (burning smell, etc.) occurs, stop the air conditioner and disconnect the power supply plug or turn off the breaker.

- If the unit continues to be operated in an abnormal condition, it may cause a fire, trouble, etc. In this case, consult your dealer.



Do not insert your finger or a stick, etc. into the air inlet/outlet.

- Since the fan rotates at high speed, this may cause an injury.
- Young children should be supervised to ensure that they do not play with the air conditioner.

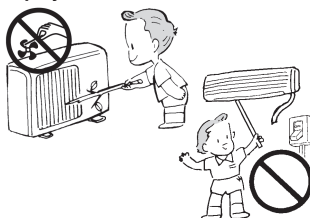

Repair or relocation should not be done by the customer.

- If this is done incorrectly, it may cause a fire, an electric shock, or injury from the unit falling, water leaking, etc. Consult your dealer.



The customer should not install this unit.

- If this is done incorrectly, it may cause a fire, an electric shock, or injury from the unit falling, water leaking, etc. Consult your dealer.

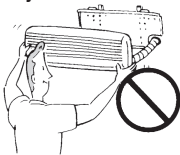

⚠ CAUTION

When the air filter is to be removed, do not touch the metal parts of the indoor unit.

- This may cause an injury.

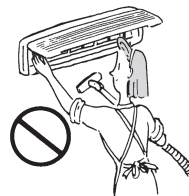

When the unit is to be cleaned, switch it off and disconnect the power supply plug or turn off the breaker.

- Since the fan rotates at high speed during operation, this may cause an injury.

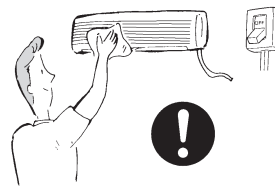

Do not operate switches with wet hands.

- This may cause an electric shock.



Do not clean the air conditioner with water.

- Water may enter the unit and degrade the insulation. This may cause an electric shock.



Do not put a pet or houseplant where it will be exposed to direct airflow.

- This could injure the pet or plant.



Do not use an insecticide or flammable spray.

- This may cause a fire or deformation of the cabinet.

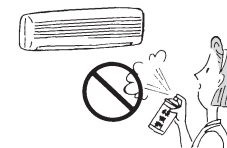

Ventilate well in using the unit with a stove, etc.

- An oxygen shortage may occur.

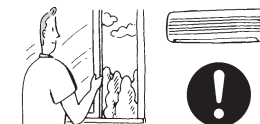

Do not use the unit for special purposes.

- Do not use this air conditioner to preserve precision devices, food, animals, plants and art objects. This may cause deterioration of quality, etc.

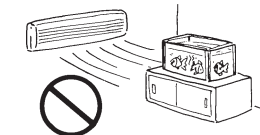

Do not put a stove, etc. where they are exposed to direct airflow.

- This may cause imperfect combustion.

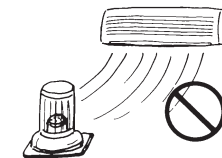



SAFETY PRECAUTIONS

⚠ CAUTION

When the unit is not going to be used for a long time, disconnect the power supply plug or turn off the breaker.

- Otherwise, dirt may collect and this may cause a fire.



Do not step or put anything on the indoor/outdoor unit.

- This may cause an injury, etc. if you fall down.

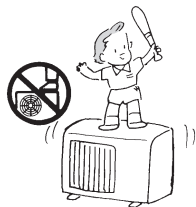

Do not leave the unit on an installation stand which is damaged.

- The unit may fall and this may cause an injury.

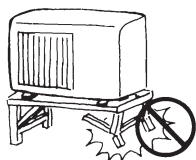

Do not operate the unit for a long time in high humidity, e.g. leaving a door or window open.

- In the cooling mode, if the unit is operated in a room with high humidity (80% RH or more) for a long time, water condensed in the air conditioner may drop and wet or damage furniture, etc.

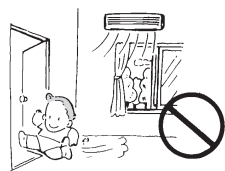

Do not step onto an unstable bench when maintaining the unit, etc.

- This may cause an injury, etc. if you fall down.



Do not pull the power supply cord.

- The core wire of the power supply cord may be disconnected and this may cause a fire.

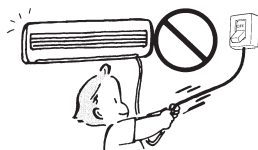

Replace the 2 batteries with new ones of same type.

- Using an old battery together with a new one may result in heat generation, leakage or an explosion.



Do not charge or disassemble the batteries and do not throw them into a fire.

- This may result in leakage, fire or an explosion.



If liquid from the alkaline batteries gets onto your skin or clothes, wash it well with clean water.

- If liquid from the alkaline batteries gets into your eyes, wash them well with clean water and consult a doctor at once.

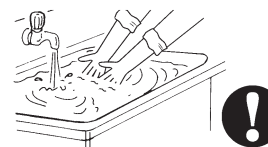

For installation

⚠ WARNING

- Consult your dealer for installation of the air conditioner.

⚠ CAUTION

Earth the unit.

- Do not connect the earth to a gas pipe, water pipe, lightning rod or the earth of a telephone. If the earthing is incorrect, it may cause an electric shock.



Do not install the unit where flammable gas could leak.

- If gas leak and collect around the unit, it may cause an explosion.



Install an earth leakage breaker depending on the place where the air conditioner is to be installed (humid places, etc.).

- If the earth leakage breaker is not installed, it may cause an electric shock.



Drain should be fully drained.

- If the drainage route is incomplete, water may drop from the unit. This may wet and damage the furniture.

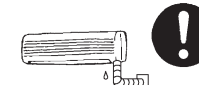



NAME OF EACH PART

Indoor unit

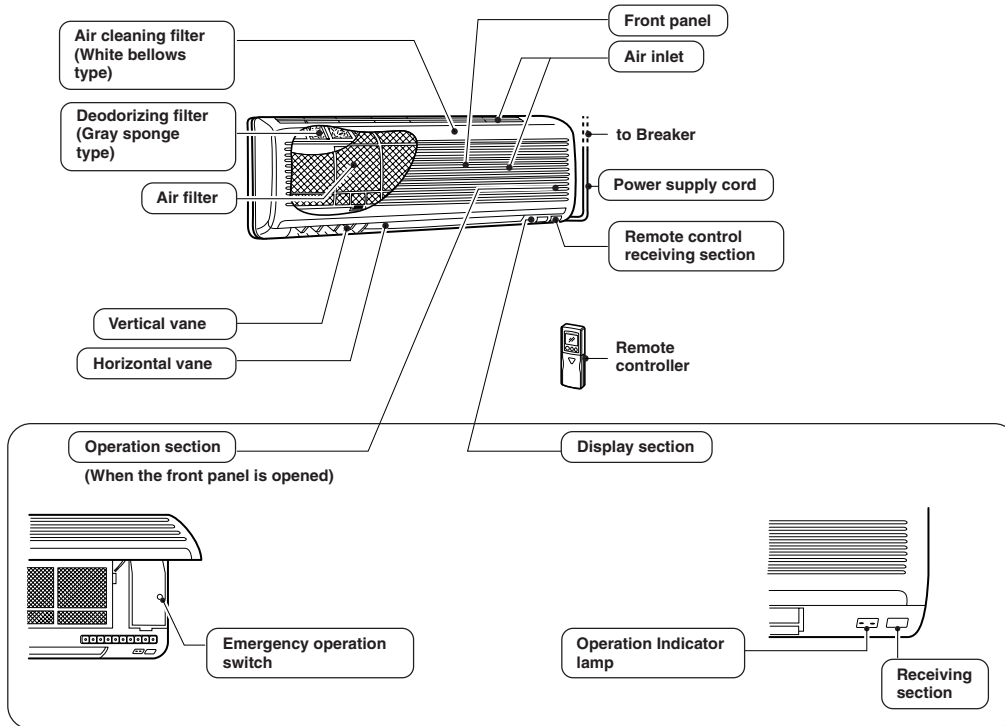

Outdoor unit

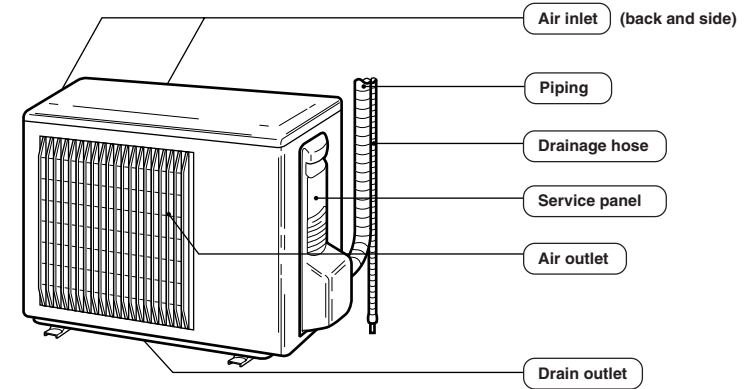



NAME OF EACH PART

Remote controller

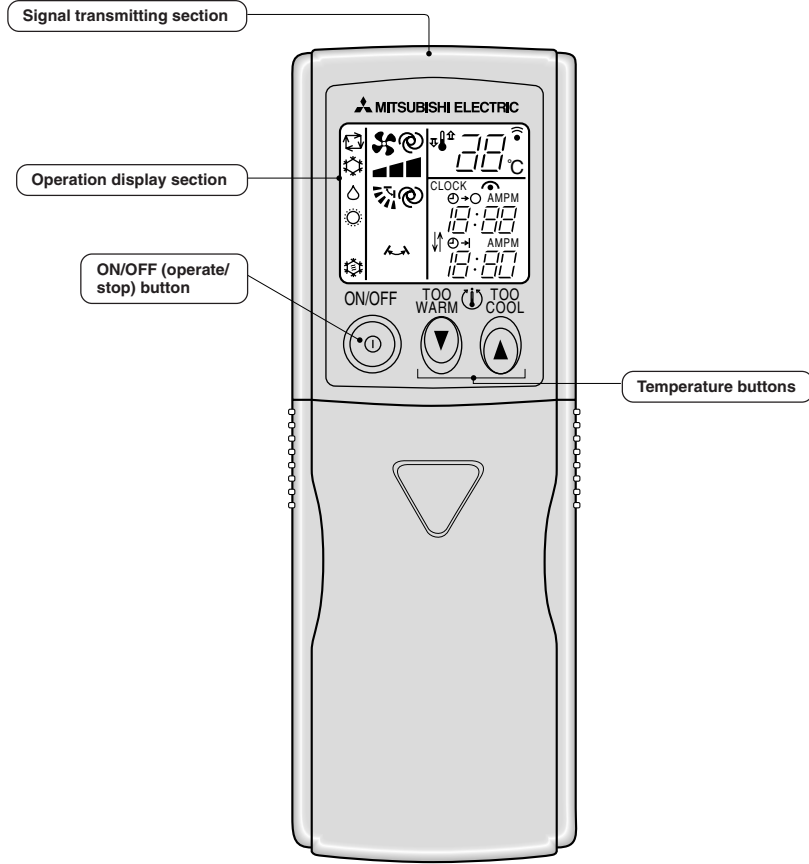

(This diagram shows an overall view.)

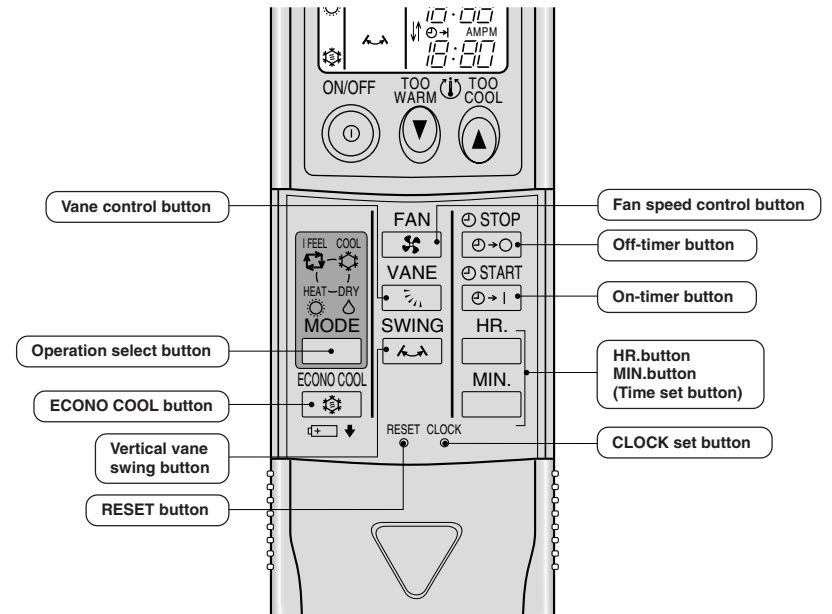
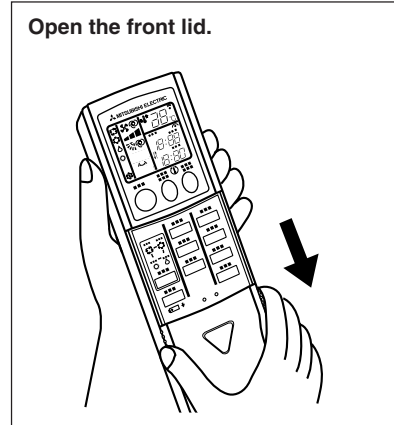



PREPARATION BEFORE OPERATION

Auto restart function

These models are equipped with an auto restart function, but this function is OFF when the units are shipped from the factory. If you want to use the auto restart function, please consult the service representative because the setting of the unit needs to be changed.

Auto restart function is ...

When the indoor unit is controlled with the remote controller, the operation mode, the set temperature and the fan speed are stored in the memory. If a power failure occurs or the main power is turned off during operation, "Auto restart function" sets automatically to start operating in the same mode as the one set with the remote controller just before the shutoff of the main power.

Indoor unit

Insert the power supply plug into the power outlet and/or turn the breaker on.

WARNING

Remove dirt from the power supply plug and insert the plug securely. If dirt adheres to the plug or insertion is incomplete, it may cause a fire or an electric shock.

Remote controller (How to set the batteries and the current time)

1 Remove the front lid and insert batteries. Then reattach the front lid.

Insert the minus pole of the batteries first. Check if the polarity of the batteries is correct.

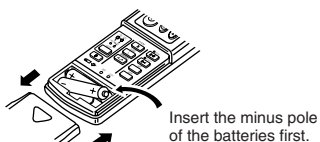

2 Press the RESET button.

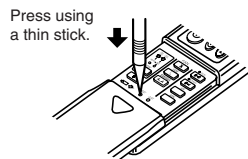

■ If the RESET button is not pressed, the remote controller may not operate correctly.

3 Press the CLOCK set button.

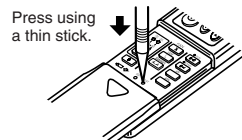

4 Press the **HR.** and **MIN.** button (TIME SET button) to set the current time.

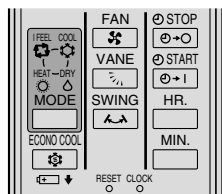

■ Each time the **HR.** button is pressed, the set time increases by 1 hour, and each time the **MIN.** button is pressed, the set time increases by 1 minute.

5 Press the CLOCK set button again and close the front lid.

Handling of the remote controller

- The range that the signal can reach is about 6 m when the remote controller is pointed at the front of the indoor unit.
- When a button is pressed, one or two beeps will be heard from the indoor unit. If no sound is heard, operate again.
- Use the remote controller carefully. If it is dropped, thrown or it gets wet, the remote controller may not operate.

When installing on a wall, etc.

- Install the remote controller installation case in a position where the signal reception sound (beep) can be heard from the indoor unit when the button is pressed.

How to install/remove the remote controller

Installing Insert the remote controller downward.

Removing Pull it up.

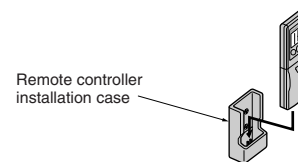

Dry-cell batteries

Reference for replacing batteries

When the indoor unit does not respond to the signal from the remote controller, or the display becomes dim, replace the batteries with new ones (size AAA).

- Though both alkaline batteries and manganese batteries can be used, alkaline batteries are recommended because their service life is longer than that of manganese batteries.
- The service life of an alkaline battery is about 1 year. However, a battery which the time limit is approaching may be exhausted soon. The recommended usable time limit is indicated (month/year) on the bottom of the battery.
- Replace the 2 batteries with new ones of the same type.
- Do not use rechargeable batteries.
- To prevent liquid leakage, take out all batteries when the remote controller is not going to be used for a long time.
- Dispose of exhausted batteries in the correct manner.

When the remote controller cannot be used (emergency operation)

When the batteries of the remote controller run out or the remote controller malfunctions, the emergency operation can be done using the EMERGENCY OPERATION switch.

1 Press the EMERGENCY OPERATION switch.

* Each time the EMERGENCY OPERATION switch is pressed, the unit will operate in order of EMERGENCY COOL MODE, EMERGENCY HEAT MODE and STOP MODE. However, when the EMERGENCY OPERATION switch is once pressed, the unit will operate in test run for 30 minutes and then the operation mode shifts to EMERGENCY MODE.

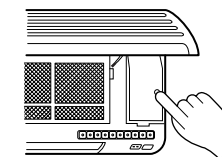

Details of EMERGENCY MODE are as shown below. However, the temperature control does not work for 30 minutes in test run and the unit is set to continuous operation. The fan speed is set to Hi in test run and shifts to Medium after 30 minutes.

Operation mode	COOL	HEAT
Set temperature	24°C	24°C
Fan speed	Medium	Medium
Horizontal vane	Auto	Auto
Vertical vane	unspecified*	unspecified*

* The vertical vane remains in the same position as the one in the last operation by the remote controller.

The operation mode is indicated by the Operation Indicator lamp on the indoor unit as following figures.

Operation Indicator lamp

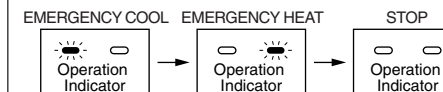

To stop the emergency operation, press the EMERGENCY OPERATION switch once (in case of EMERGENCY HEAT MODE) or twice (in case of EMERGENCY COOL MODE).



I FEEL... AUTO OPERATION

With the “I FEEL...” auto operation mode, the optimum room condition can be set automatically with a one-touch operation.

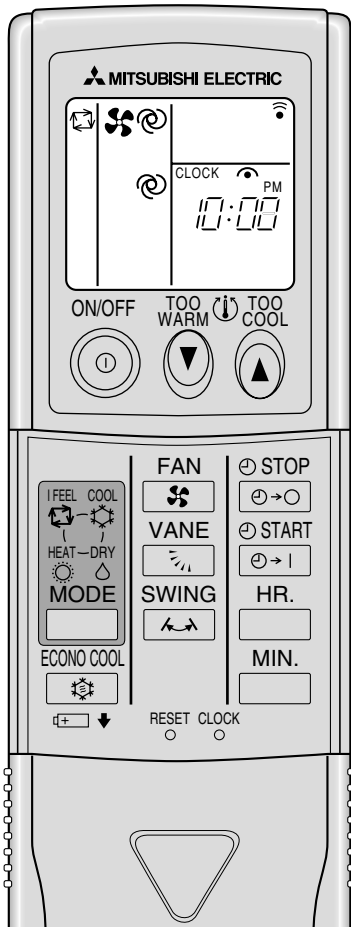

- To start operation:
 - Press the button.

When the “I FEEL...” mode is selected, the air conditioner is automatically controlled at the optimum temperature.

- To stop operation:
 - Press the button.

- If you feel slightly warm:
 - Press the button to lower the temperature.
 - One press lowers the temperature by about 1°C.
- If you feel slightly cool:
 - Press the button to raise the temperature.
 - One press raises the temperature by about 1°C.

When “I FEEL...” is not selected, press the button until it is set.

Each time the button is pressed, the operation mode is changed in sequence: (I FEEL...) → (COOL) → (DRY) → (HEAT)

Description of “I FEEL...” mode

Details of operation

According to the room temperature when the operation starts, the operation mode is automatically set to COOL, DRY or HEAT. However, when operation is started again within 2 hours after it is stopped, the same operation mode before the operation is stopped is selected. The operation mode selected first is not changed even if the room temperature changes. If the operation mode does not match the room condition, select the appropriate operation mode by pressing the button.

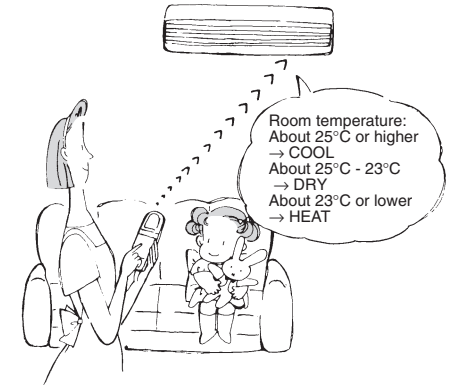

Details of auto operation

Room temperature when started	Operation mode	Target temperature (initial state)
About 25°C or higher	COOL	About 24°C
About 25°C - 23°C	DRY	—
About 23°C or lower	HEAT	About 26°C

NOTE

- COOL:** When the room temperature is 2°C higher than the set temperature, the set temperature may not be changed since the air conditioner is operating to reach the target (set) temperature. In this case, please wait until the room temperature drops to within 2°C of the set temperature and then change the set temperature.
- HEAT:** When the room temperature is 2°C lower than the set temperature, the set temperature may not be changed since the air conditioner is operating to reach the target (set) temperature. In this case, please wait until the room temperature rises to within 2°C of the set temperature and then change the set temperature.

Details of display on the indoor unit

The operation indicator at the right side of the indoor unit indicates the operation state.

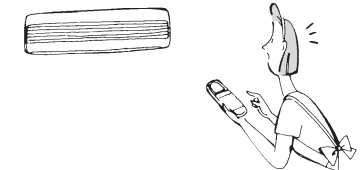

	Lighted
	Not lighted

Operation indicator lamp

Indication	Operation state	Difference between target temperature and room temperature
	This shows that the air conditioner is operating to reach the target temperature. Please wait until the target temperature is obtained.	About 2°C or more
	This shows that the room temperature is approaching the target temperature.	About 2°C or less



MANUAL OPERATION (COOL, DRY, HEAT)

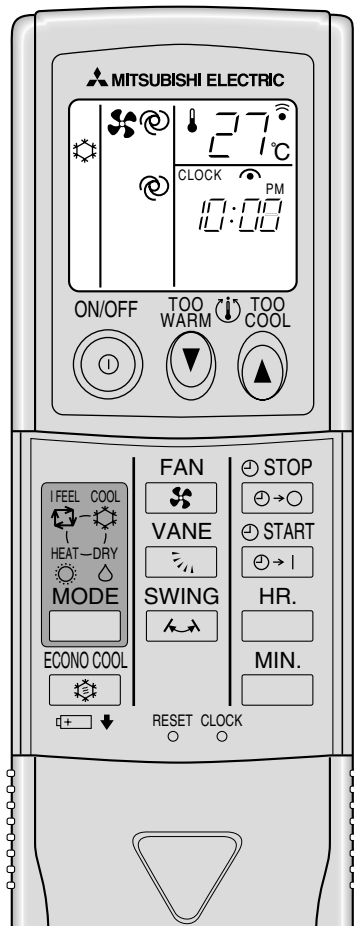

To select the COOL, DRY or HEAT mode

- 1 Press the button.
 - 2 Select the operation mode by pressing the button.
- Each time this button is pressed, the operation mode is changed in sequence: (I FEEL...) → (COOL) → (DRY) → (HEAT)

To stop operation:

- Press the button.
- After the operation mode is set once, the operation starts in the same mode as the one set previously from the next time by simply pressing the button.

When the set temperature is to be changed:

- Press the button to lower the temperature. One press lowers the temperature by about 1°C.
- Press the button to raise the temperature. One press raises the temperature by about 1°C.

In DRY operation

- The temperature control (temperature setting) cannot be done.
- The room temperature is slightly lowered in this operation mode.

The details of the display on the indoor unit are explained on page 8.

NOTE

When the ambient temperature is too high, the room temperature may not reach the set temperature since the unit operates to cool under high load.

CONVENIENT INFORMATION

COOL For effective cooling

- ① Close the windows and pull down blinds. Sunshine is reduced and cooling efficiency increases.
- ② Paste a heat shield film (generally available) on the window. Heat entering the room is reduced.
- ③ Block the outdoor unit from direct sunlight. This saves energy.

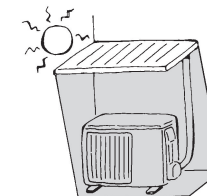
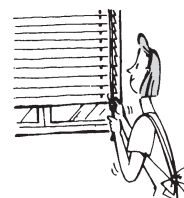

HEAT Comfortable warmth depends on the temperature difference between the indoor and the outdoor.

It is recommended that the set temperature in the heating operation does not differ from the external temperature too much. Though there is a regional difference, as a reference, a set temperature between about 22°C and 24°C is most suitable.

DRY The humidity at which people feel comfortable

When air contains too much moisture, people feel uncomfortable. Humidity is related to temperature and wind. The humidity at which people feel comfortable is 60% - 75% RH in summer, 55% - 70% RH in winter.





AIR FLOW VELOCITY AND DIRECTION ADJUSTMENT

AIR FLOW velocity and direction can be selected as required.

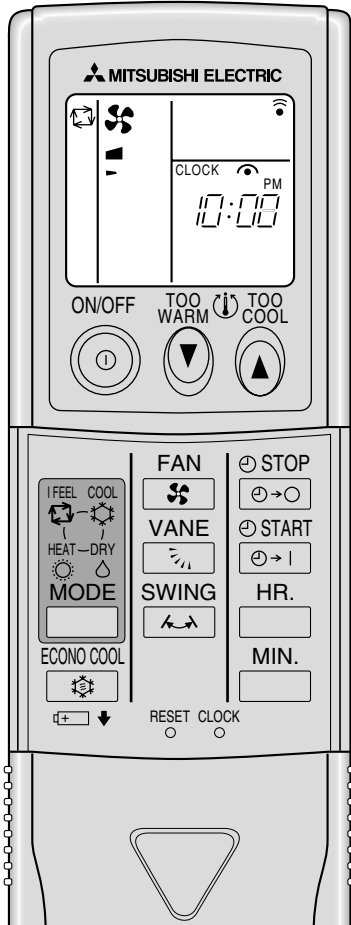

To change the AIR FLOW velocity, press the **FAN** button.

Each time the button is pressed, the fan speed is changed in sequence: (Lo) → (Med) → (Hi) → (AUTO)

- Use the (Hi) notch to cool/heat the room more.
- If the operating sound of the air conditioner disturbs your sleep, use the (Lo) notch.

To change the AIR FLOW blowing direction vertically, press the **VANE** button.

Each time the button is pressed, the angle of the horizontal vane is changed in sequence: (1) → (2) → (3) → (4) → (5) → (SWING) → (AUTO)

SWING OPERATION
Use the swing operation for the air flow to reach all corners of the room.

Recommended horizontal vane range

Use the (AUTO) position usually.

Use position (1) or (2) in the COOL or DRY mode and use positions (3) to (5) in the HEAT mode when adjusting to your requirements.

To change the horizontal AIR FLOW blowing direction:

- Press the **SWING** button. The vertical vane begins moving.
- When the vane moves to the desired position, press the **SWING** button again. The vane stops moving.

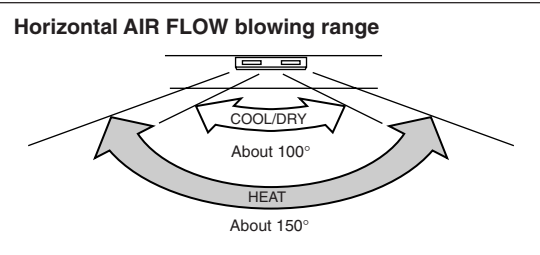

Auto air flow direction control operation

When the AUTO mode is selected with the **VANE** button, the position of the horizontal vane is automatically set to correspond to the operation mode for effective operation.

(1) HEAT
When the air flow temperature is too low, the air is blown out horizontally.

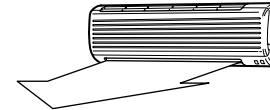

When the air flow temperature rises, the air is blown out downwards.

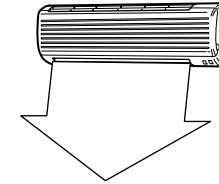

(2) COOL, DRY
The air is blown out horizontally.

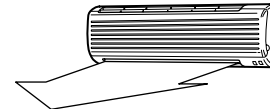

- NOTE**
- In the cooling operation, when the air conditioner is operated with setting the horizontal vane to (4) or (5) for 1 hour, the AIR FLOW direction is automatically set to horizontal to prevent condensed water from dropping.
 - Adjust the vertical and horizontal AIR FLOW direction using the remote controller. If the horizontal vane or the vertical vane is moved manually, it may cause trouble.
 - In the heating operation, if the air flow temperature is too low or when defrosting is being done, the horizontal vane position is set to (1).



ECONO COOL OPERATION

Use this operation when you want to be comfortable in COOL mode even with energy saved.

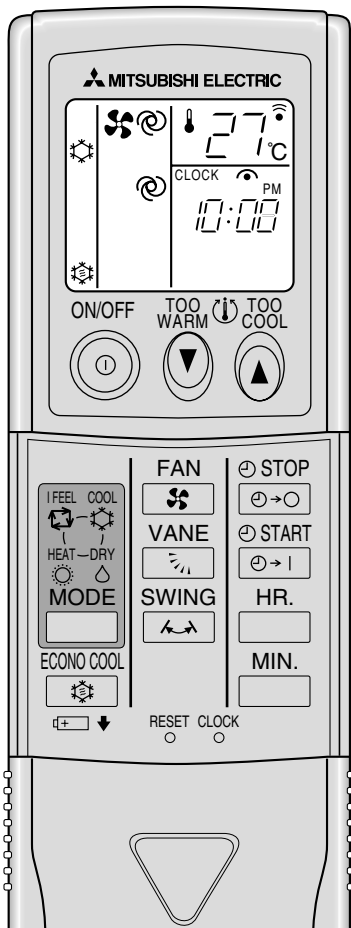

Perform the following operations while the unit is operating.

Press the  button.

When the  (ECONO COOL) operation is selected in COOL mode, the air conditioner performs swing operation in various cycle according to the temperature of air conditioner.

Also SET TEMPERATURE is automatically set 2°C higher than in COOL mode.

To release the ECONO COOL operation:

Press the  button again.

■ ECONO COOL operation is available only in MANUAL COOL mode.

■ When the  button is pressed or the operation mode is changed during the ECONO COOL operation, ECONO COOL operation is released.

■ The , the  or  button and ON/OFF timer (page 12) are available.

What is "ECONO COOL"?

Swing air flow (change of air flow) makes you feel cooler than constant air flow. So, even though the set temperature is automatically set 2°C higher, it is possible to operate cooling operation with keeping comfort. As a result, energy can be saved.



SWING OPERATION

Use the swing operation for the air flow to reach all corners of the room.

Perform the following operations while the unit is operating.

Press the  button.

To release the SWING operation:

Press the  button again.

Refer to "To change the horizontal AIR FLOW blowing direction" on page 10.

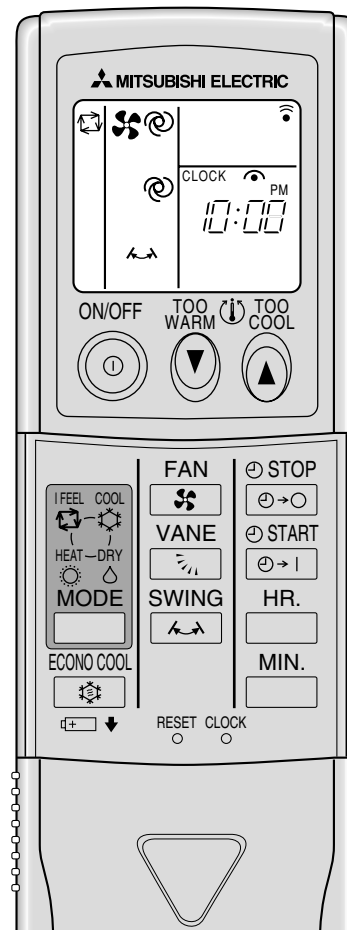



TIMER OPERATION (ON/OFF TIMER)

TIMER

It is convenient to set the timer when you go to bed, when you get home, when you get up, etc.

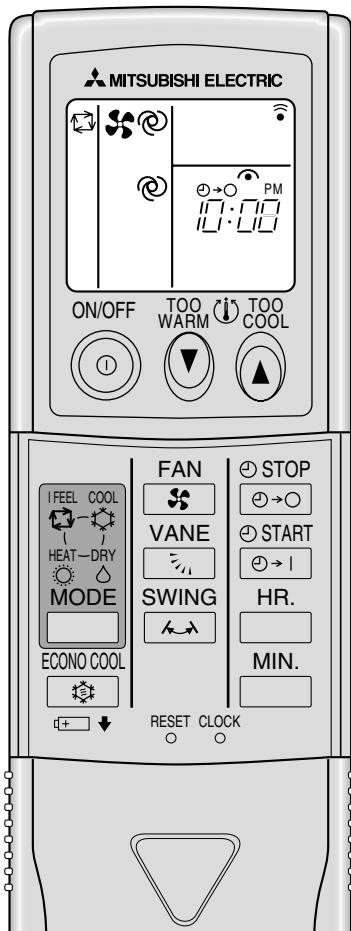

How to set the ON timer

- 1 Press the button during operation.
Each time the button is pressed, the ON timer mode alternates between ON and OFF.
- 2 Set the time of the timer using the and buttons.
Each time the button is pressed, the set time increases by 1 hour; each time the button is pressed, the set time increases by 10 minutes.

To release the ON timer:

- Press the button.

How to set the OFF timer

- 1 Press the button during operation.
Each time the button is pressed, the OFF timer mode alternates between ON and OFF.
- 2 Set the time of the timer using the and buttons.
Each time the button is pressed, the set time increases by 1 hour; each time the button is pressed, the set time increases by 10 minutes.

To release the OFF timer:

- Press the button.

Programming timer operation

The ON timer and the OFF timer can be used in combination. The timer of the set time that is reached first will operate first. ("↑" mark indicates the order of timer operations.)

- If the current time has not been set, the timer operation cannot be used.

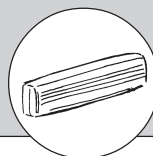

WHEN THE AIR CONDITIONER IS NOT GOING TO BE USED FOR A LONG TIME

When it is not going to be used for a long time:

- 1 Perform the FAN operation for 3 or 4 hours to dry the inside of the air conditioner.
 - To perform FAN operation, set to the highest temperature in the MANUAL COOL OPERATION mode. (Refer to page 9.)

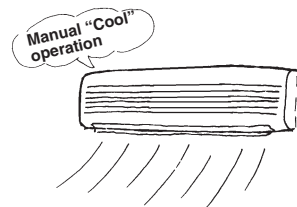

- 2 Turn off the breaker and/or disconnect the power supply plug.

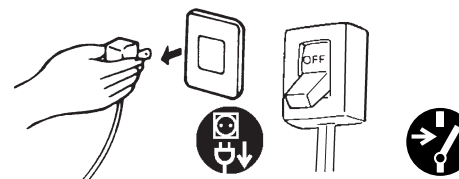

CAUTION
Turn off the breaker or disconnect the power supply plug when the air conditioner is not going to be used for a long time.
Dirt may collect and this may cause a fire.

- 3 Remove the batteries from the remote controller.

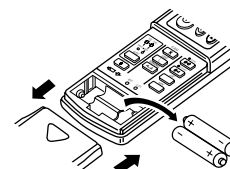

CAUTION
To prevent liquid leakage, take out all batteries when the remote controller is not going to be used for a long time.

When the air conditioner is to be used again:

- 1 Clean the air filter and install it in the indoor unit.
(Refer to page 13 for cleaning instructions.)

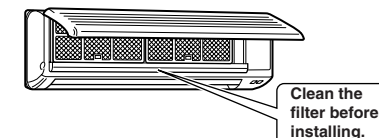

- 2 Check that the air inlet and outlet of the indoor/outdoor units are not blocked.

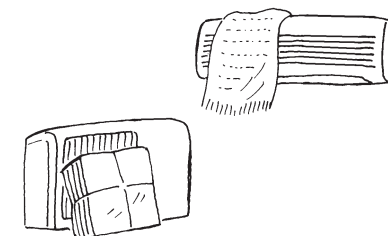

- 3 Check that the earth is connected correctly.

CAUTION
Earth the unit.
Do not connect the earth to a gas pipe, water pipe, lightning rod or the earth of a telephone. If the earthing is incorrect, it may cause an electric shock.



MAINTENANCE

Before starting maintenance

Turn off the breaker and/or disconnect the power supply plug.

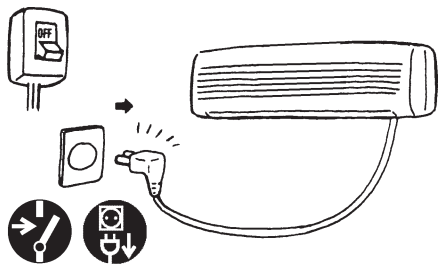

CAUTION

When the unit is to be cleaned, switch it off and disconnect the power supply plug or turn off the breaker. Since the fan rotates at high speed during operation, it may cause an injury.



Cleaning the indoor unit

Clean the unit using a soft dry cloth.

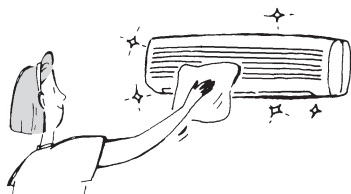

Do not use gasoline, benzine, polishing powder, detergent and insecticide. The unit may be damaged.



CLEANING THE AIR FILTER AND THE DEODORIZING FILTER

Do not open the front panel up past the level position in order to prevent it from being damaged.

Cleaning the air filter (about once every 2 weeks)

1 Remove the air filter.

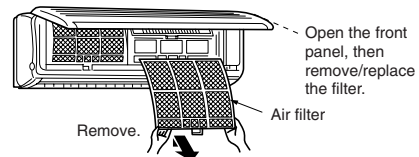

CAUTION

When the air filter is to be removed, do not touch the metal parts of the indoor unit. This may cause an injury.

2 Remove dirt from the air filter using a vacuum cleaner or by washing the filter with water.

- If dirt is conspicuous, wash the filter with a solution of detergent in lukewarm water.
- If hot water (50°C or more) is used, the filter may be deformed.

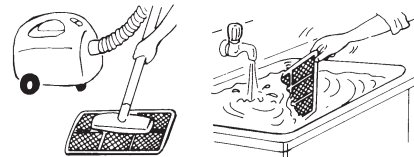

3 After washing with water/lukewarm water, dry the air filter well in the shade.

- Do not expose the air filter to direct sunlight or heat from a fire when drying it.

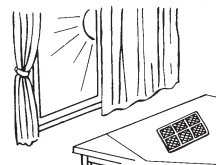

4 Install the air filter.

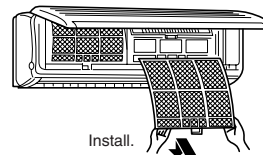

Cleaning the deodorizing filter (about once every 2 weeks)

1 Remove the air filter, and then remove the deodorizing filter (Gray sponge type).

- The deodorizing filter is harmless to people. However, to keep its effectiveness, be sure to hold the frame and not to touch the surface of the filter with your hand.

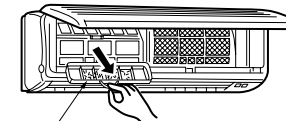

2 Soak the filter together with its frame in lukewarm water for about 15 minutes.

- If the dirt is conspicuous, use a solution of detergent in lukewarm water.
- If hot water (50°C or more) is used, the filter may be deformed.
- Do not use a scrubbing brush or sponge. This may damage the surface of the filter.
- Do not use a chlorine detergent.



3 After washing with water/lukewarm water, dry the deodorizing filter well in the shade.

- Do not expose the deodorizing filter to direct sunlight or heat from a fire when drying it.

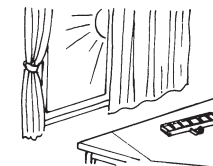

4 Install the deodorizing filter, and then install the air filter.

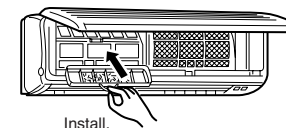



REPLACEMENT OF THE DEODORIZING FILTER/ AIR CLEANING FILTER

When the capacity is lowered because of dirt, etc., it is necessary to replace the deodorizing filter/air cleaning filter.

Deodorizing filter replacement (about once a year)

- 1 Remove the air filter.

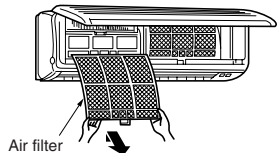

- 2 Remove the deodorizing filter (Gray sponge type).

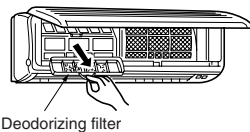

- 3 Install a new deodorizing filter.

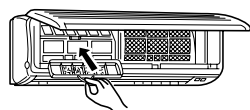

- 4 Install the air filter and securely close the front panel.

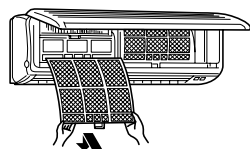

Deodorizing filter

- Cleaning is necessary about once every 2 weeks. However, if dirt is conspicuous, clean more often.
- When the colour of the filter is not restored even if the filter is washed as the procedure shown on page 13 or when the filter becomes black, replace the filter with a new one.
- Standard interval for filter replacement is about 1 year.

Optional parts

Optional parts are available from your local dealer.

Name of part	Type name
DEODORIZING FILTER	MAC-1800DF
AIR CLEANING FILTER	MAC-1300FT

Air cleaning filter replacement (about once every 4 months)

- 1 Remove the air filter.

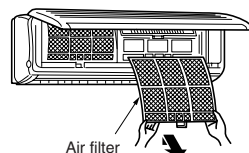

- 2 Remove the air cleaning filter (White belows type).

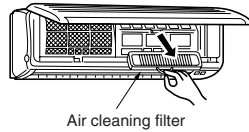

- 3 Install a new air cleaning filter.

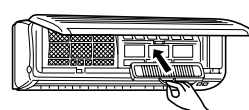

- 4 Install the air filter and securely close the front panel.

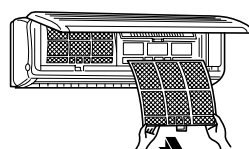

Air cleaning filter

- If the air cleaning filter is clogged, it may lower the unit's capacity or cause condensation at the air outlet.
- The air cleaning filter is disposable. The standard usable term is about 4 months. However, if the colour of the filter turns to dark brown, replace the filter at once.



BEFORE CONTACTING THE SERVICE REPRESENTATIVE, CHECK THE FOLLOWING AGAIN

The air conditioner cannot be operated.
↓
Check the following.

- 1 Is the breaker turned on?



- 2 Isn't the fuse blown?

- 3 Isn't the ON-timer set?



Cannot be cooled or heated sufficiently.
↓
Check the following.

- 1 Is the temperature setting correct?



- 2 Isn't the filter dirty?

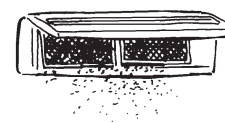

- 3 Isn't the outlet of the outdoor unit blocked?

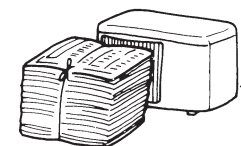

Display of the remote controller does not appear (1, 2). The remote control signal cannot be received if the remote controller is not operated near the air conditioner (1).

↓
Check the following.

- 1 Aren't the batteries exhausted?



- 2 Is the polarity (+, -) of the batteries correct?



When a power failure occurs.

To restart the unit, press the ON/OFF button on the remote controller again after the restoration of the power.











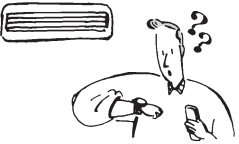

Even if the above items are checked, when the air conditioner does not recover from the trouble, stop using the air conditioner and consult your dealer.

In the following cases, stop operation and consult your dealer.

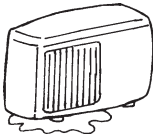
- The remote control signal may not be received in a room where an electronic ON/OFF type fluorescent lamp (inverter-type fluorescent lamp, etc.) is used.
- In the region where the electric wave is weak, when the air conditioner is operated, noise may be generated in radio reception.
- When thunder is heard, stop operation and disconnect the power supply plug or turn off the breaker. Otherwise, the electrical parts may be damaged.

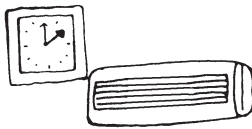

WHEN YOU THINK THAT TROUBLE HAS OCCURRED

Question	Answer (not a malfunction)	Question	Answer (not a malfunction)
<p>The air conditioner cannot be operated for about 3 minutes when restarted.</p> 	<ul style="list-style-type: none"> This protects the air conditioner according to instructions from the microprocessor. Please wait. 	<p>Mechanical sound is heard from the indoor unit.</p> 	<ul style="list-style-type: none"> This is the switching sound in turning on/off the fan or the compressor.
<p>Cracking sound is heard.</p> 	<ul style="list-style-type: none"> This sound is generated by the expansion/contraction of the front panel, etc. due to change in temperature. 	<p>The air flow direction changes during operation.</p> 	<ul style="list-style-type: none"> When the air conditioner is operated in COOL or DRY mode, if the operation continues with air blowing down for 1 hour, the direction of the air flow is automatically set to horizontal to prevent condensed water from dropping. In the heating operation, if the air flow temperature is too low or when defrosting is being done, the horizontal vane position is automatically set to horizontal.
<p>The room smells strange.</p> 	<ul style="list-style-type: none"> The air conditioner sucks in an odor adhering to the wall, carpet, furniture, cloth, etc. and blows it out with the air. 	<p>Water leak from the outdoor unit.</p> 	<ul style="list-style-type: none"> During COOL and DRY operations, pipe or pipe connecting sections are cooled and this causes water to condense. In the heating operation, the defrosting operation makes water frozen on the outdoor unit melt and drip down. In the heating operation, water condensed on the heat exchanger drips down.
<p>The sound of water flowing is heard.</p> 	<ul style="list-style-type: none"> This is the sound of refrigerant flowing inside the air conditioner. This is the sound of condensed water flowing in the heat exchanger. This is the sound of the heat exchanger defrosting. 	<p>Air does not blow out soon in the heating operation.</p> 	<ul style="list-style-type: none"> Please wait as the air conditioner is preparing to blow out warm air.
<p>The sound as bubbling is heard.</p> 	<ul style="list-style-type: none"> This sound is heard when the outside air is absorbed from the drain hose in turning on the range hood or the ventilation fan and that makes water flowing in the drain hose spout out. This sound is also heard when the outside air blows into the drain hose in case the outside wind is strong. 	<p>The operation is stopped for about 10 minutes in the heating operation.</p> 	<ul style="list-style-type: none"> Defrosting of the outdoor unit is being done (Defrosting operation). Since this is completed in 10 minutes, please wait. (When the external temperature is too low and humidity is too high, frost is formed.)
<p>The room cannot be cooled sufficiently.</p> 	<ul style="list-style-type: none"> When a ventilation fan or a gas cooker is used in a room, the cooling load increases, resulting in an insufficient cooling effect. When the outside air temperature is high, the cooling effect may not be sufficient. 	<p>Hissing sound is sometimes heard.</p> 	<ul style="list-style-type: none"> This is the sound when the flow of refrigerant inside the air conditioner is switched.



INSTALLATION, RELOCATION AND INSPECTION

Installation place

Avoid installing the air conditioner in the following places.

- Where flammable gas could leak.

CAUTION

Do not install the unit where flammable gas could leak.

If gas leak and collect around the unit, it may cause an explosion.

- Where there is much machine oil.
- Salty places such as the seaside.
- Where sulfide gas is generated such as a hot spring.
- Where oil is splashed or where the area is filled with oily smoke.

Electrical work

- Provide an exclusive circuit for the power supply of the air conditioner.
- Be sure to observe the breaker capacity.

WARNING

- The customer should not install this unit. If installation is done incorrectly, it may cause a fire, an electric shock, or injury from the unit falling, water leaking, etc.
- Do not use intermediate connection of the power supply cord or the extension cord and do not connect many devices to one AC outlet. A fire or an electric shock may result from poor contact, poor insulation, exceeding the permissible current, etc. Consult your dealer.

CAUTION

- Earth the unit. Do not connect the earth to a gas pipe, water pipe, lightning rod or the earth of a telephone. If the earthing is incorrect, it may cause an electric shock.
- Install an earth leakage breaker depending on the place where the air conditioner is to be installed (humid places, etc.). If the earth leakage breaker is not installed, it may cause an electric shock.

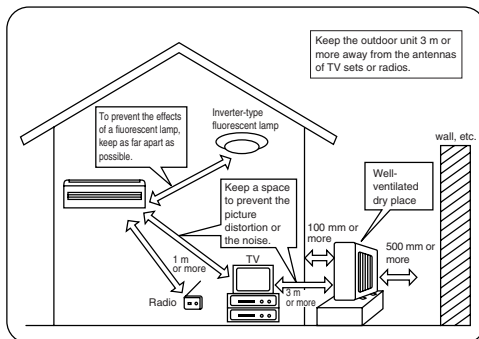

Inspection and maintenance

- When the air conditioner is used for several seasons, the capacity may be lowered due to dirt inside the unit.
- Depending on the condition, an odor may be generated or dehumidified water may not drain out smoothly due to dirt, dust, etc.
- It is recommended that the unit be inspected and maintained (charged) by specialist in addition to normal maintenance. Consult your dealer.

Operating sound considerations

- Do not put an object around the air outlet of the outdoor unit. This may lower the capacity or increase the volume of the operating sound.
- If an abnormal sound is heard during operation, consult your dealer.

Relocation

- When the air conditioner is to be removed or re-installed because of rebuilding, moving, etc., special techniques and work are required.

WARNING

Repairs or relocation should not be done by the customer. If this is done incorrectly, it may cause a fire, an electric shock, or an injury from the unit falling, water leaking, etc. Consult your dealer.

Disposal

To dispose of this product, consult your dealer.

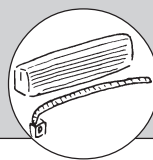

SPECIFICATIONS

Model	Indoor		MSZ-G09SV		MSZ-G12SV	
	Outdoor		MUZ-G09SV		MUZ-G12SV	
Function			Cooling	Heating	Cooling	Heating
Power supply			~ /N, 230V, 50Hz			
Capacity	kW		2.6	3.6	3.5	4.8
Input	kW		0.94	1.14	1.29	1.54
Weight	Indoor	kg	9		10	
	Outdoor	kg	28		34	
Refrigerant filling capacity (R-22)	kg		0.75		1.10	
IP code	Indoor		IP20			
	Outdoor		IP24			
Permissible excessive operating pressure	LP ps	MPa	1.3			
	HP ps	MPa	4.3		3.8	
Noise level (Hi)	Indoor	dB(A)	36	35	39	
	Outdoor	dB(A)	45		48	

Note:

1. Rating condition

Cooling — Indoor: 27°C DB, 19°C WB
 Outdoor: 35°C DB
 Heating — Indoor: 20°C DB
 Outdoor: 7°C DB, 6°C WB

2. Guaranteed operating range

		Indoor	Outdoor
Cooling	Upper limit	32°C DB 23°C WB	43°C DB —
	Lower limit	21°C DB 15°C WB	21°C DB —
Heating	Upper limit	27°C DB —	21°C DB 15°C WB
	Lower limit	20°C DB —	-8.5°C DB -9.5°C WB

If you have any questions, consult your dealer.

This product is designed and intended for use in the residential, commercial and light-industrial environment.

The product at hand is based on the following EU regulations:

- Low Voltage Directive 73/23/ EEC
- Electromagnetic Compatibility Directive 89/336/ EEC