

# 9 Operating Instructions

## 9.1. CS-E15DKRW

### ■ Definition

To prevent personal injury, injury to others and property damage, the following instructions must be followed.

Incorrect operation due to failure to follow instructions will cause harm or damage, the seriousness of which is classified as below:

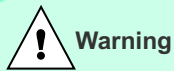

**Warning**

This sign warns of death or serious injury.



**Caution**

This sign warns of injury or damage to property.

The instructions to be followed are classified by the following symbols:



This symbol denotes an action that is **PROHIBITED**.



These symbols denote actions that are **COMPULSORY**.

Thank you for purchasing Panasonic Air Conditioner

## SAFETY PRECAUTIONS

### Installation Precautions



**Warning**

Do not install, remove and reinstall the unit by yourself.

- Improper installation will cause leakage, electric shock or fire. Please consult an authorized dealer or specialist for the installation work.



**Caution**



- This air conditioner must be earthed. Improper grounding will cause electric shock.
- Ensure that the drainage piping is connected properly. Otherwise, water will leak.
- Current leakage protection equipment must be installed. Otherwise, electric shock or fire may occur.



- Do not install the unit in a potentially explosive atmosphere.

### Operation Precautions



**Warning**



- Do not share power outlet.
- Do not modify power cord.
- Do not use an extension cord.
- Do not operate with wet hands.
- Do not insert finger or other objects into the indoor or outdoor unit.
- Do not attempt to repair the unit by yourself.
- Do not use rechargeable (Ni-Cd) batteries.
- Keep the remote control away from infants and small children to prevent them from accidentally swallowing the batteries.



- Use specified supply cord.
- If the supply cord is damaged or needed to be replaced, it must be replaced by the manufacturer or its service agent or a similarly qualified person in order to avoid a hazard.
- Remove the batteries if the unit is not going to be used for a long period of time.
- New batteries of the same type must be inserted following the polarity stated to prevent malfunction of the remote control.



- In case of emergency or abnormal condition (burnt, smell, etc) occurs, turn off the power supply.



**Caution**



- Do not wash the unit with water, benzene, thinner or scouring powder.
- Do not use for other purposes such as preservation of food.
- Do not use any combustible equipment at airflow direction.
- Do not sit or place anything on the indoor or outdoor unit.
- Do not expose directly to cold air for a long period.



- Ventilate the room regularly.
- Pay attention as to whether the installation rack is damaged after long period of usage.



- Switch off the power supply before cleaning or servicing.
- Turn off the power supply if the unit is not used for a long period of time.

### Safety Regulation

The appliance is not intended for use by young children or infirm person without supervision. Young children should be supervised to ensure that they do not play with the appliance.

### Operation Condition (°C)

Use this air conditioner under the following temperature range.

DBT: Dry Bulb Temperature WBT: Wet Bulb Temperature	Indoor		Outdoor	
	DBT	WBT	DBT	WBT
Maximum Temperature (COOL)	32	23	43	26
Maximum Temperature (HEAT)	30	—	24	18
Minimum Temperature (COOL)	16	11	-5	—
Minimum Temperature (HEAT)	16	—	-5	-6

Note: The illustrations in this manual are for explanation purposes only and may differ from the actual unit. It is subjected to change without notice for future improvement.

## PRODUCT OVERVIEW

### Indoor Unit

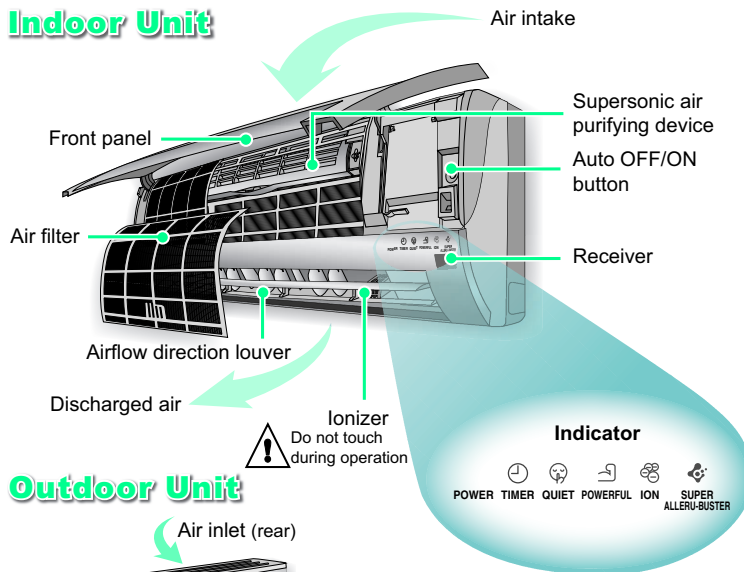

### Outdoor Unit

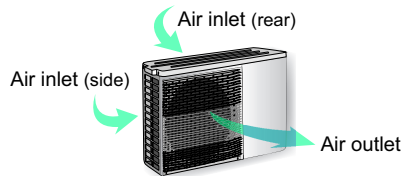

### Remote Control

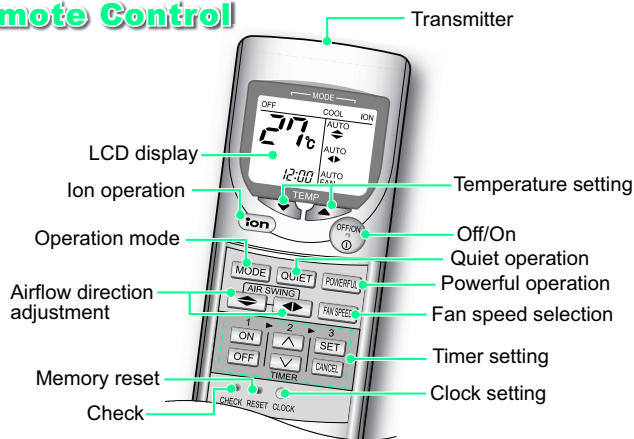

### About

#### Remote Control Preparation

1. Pull out
  2. Insert batteries (AAA or R03)
  3. Press CLOCK button
  4. Set current time
  5. Press again to confirm
- Timer operation will be based on current time set.
  - The batteries can be used for approximately 1 year.
  - The batteries must be recycled or disposed of properly.

#### Remote Control Signal

- Make sure it is not obstructed.
- Maximum distances: 10m.
- Certain fluorescent lights may interfere with signal transmission. Consult your dealer.

#### Auto OFF/ON Button

- To operate the unit if the remote control is misplaced or malfunctioning.

Action	Operation mode
Press once	Automatic Operation
Press until "beep" sound and release.	Cooling Operation
Press until "beep" sound and release. Press again until "beep-beep" sound and release.	Heating Operation

- To OFF, press again the Auto OFF/ON button.

### Troubleshooting

- Operation delayed for few minutes after restart. ➤ This is a normal self protection control.
- Sound like water flowing during operation. ➤ Caused by refrigerant flow inside.
- Mist emerges from indoor unit. ➤ Condensation effect due to cooling process.
- Noisy during operations. ➤ Installation work could be slanted or front panel didn't close properly.
- Remote control/display does not work. ➤ Check whether batteries are correctly inserted or need replacement.
- The unit cannot operate. ➤ Check either circuit breaker is tripped or timer is used correctly.
- Outdoor unit emits water/steam. ➤ Condensation or evaporation happens at piping surface.

## HOW TO OPERATE

### Auto, Heat, Cool, Dry

#### ■ Operation Details

##### AUTO - Automatic Operation

- The unit will automatically select the operation mode according to the setting, outdoor and room temperature. During operation mode selection, power indicator blinks. For every 30 minutes, the operation mode is reselected.

##### HEAT - Heating Operation

- Enables you to enjoy the warming effect at your preferred setting temperature.
- For cold air prevention, air might not blow out immediately and power indicator blinks when operation starts.
- Also operates in defrost mode (maximum 10 minutes) where by the power indicator blinks. The melted frost is drained at outdoor unit and indoor fan is stopped.

##### COOL - Cooling Operation

- Enables you to enjoy the cooling effect at your preferred setting temperature.

##### DRY - Soft Dry Operation

- Enables you to set the desired temperature at low fan speed which provides you with the dehumidifying surroundings.

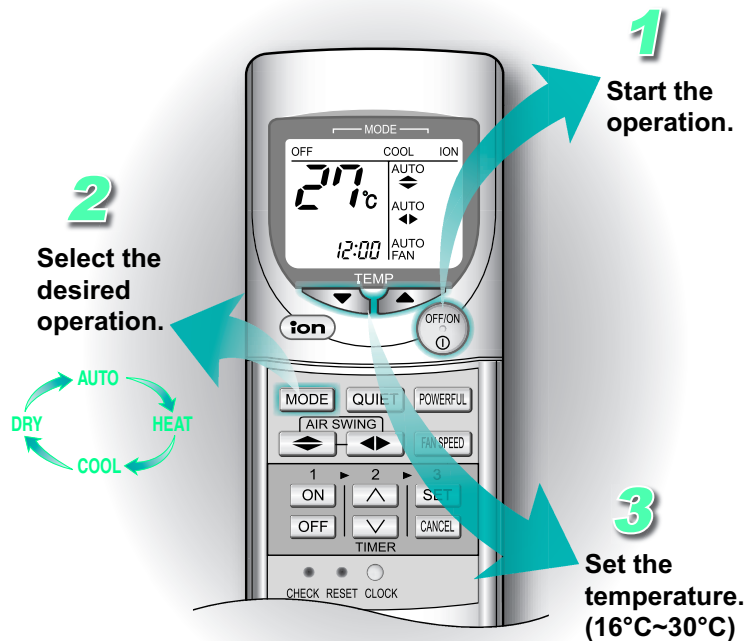

- Supersonic air purifying device (super alleru-buster) operates automatically while the air conditioner is switched on.
- Powerful, Quiet and Ion operations could be activated in all operation modes.
- Press  button again to stop the operation.



#### Hint

- To save electricity, close the curtains when using air conditioner to prevent sunlight and heat from coming in.



#### Troubleshooting

- |  |  |
|--|--|
| ● The room has a peculiar odour.                     | ➤ This may be a damp smell emitted by the wall, carpet, furniture or clothing in the room. |
| ● Air conditioner does not cool or heat efficiently. | ➤ Ensure the temperature has been set correctly.   |
|  | ➤ Ensure windows and doors have been closed properly.                                      |
|  | ➤ Ensure filters are cleaned or replaced when necessary.                                   |
|  | ➤ Ensure inlet and outlet vents of the units have not been obstructed.                     |

# HOW TO OPERATE

## Powerful, Quiet, Ion, Fan Speed, Air Swing

### ION

Enables ion operation.



### QUIET

Enables quiet operation.

### POWERFUL

Enables powerful operation.

### AIR SWING

Adjust the vertical or horizontal airflow direction louver.

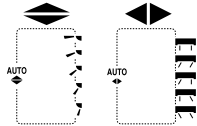

### FAN SPEED

Select fan speed.



- Powerful and Quiet operations could not be activated at the same time.
- Powerful, Quiet and Ion operations could be cancelled by pressing the respective button again.

## Operations Details

### POWERFUL

- To achieve setting temperature quickly.

### QUIET

- To provide a quiet environment.

### ION

- To provide fresh air effect by producing negative ions.
- Ion operation could be activated independently.
- Press  button to stop the operation.

### FAN SPEED

- To provide you with the various fan speed selections.
- There are 5 levels of fan speed in addition to automatic fan speed.
- Automatic fan speed:  
The speed of the indoor fan is automatically adjusted according to the operation.

### AIR SWING



- To ventilate air in the room.
- There are 5 selections in addition to automatic vertical air flow direction.
- If automatic vertical airflow direction has been set, the louver swings up and down automatically.



- To ventilate air in the room.
- There are 5 selections in addition to automatic horizontal air flow direction.
- If automatic horizontal airflow direction has been set, the louver swings left and right automatically.

- Please do not adjust the vertical and horizontal airflow direction louver manually.

### Hints



- If you wish to have the cool air blowing directly on you, set the airflow direction downward but not for an excessive length of time, as it may harm your health.
- Approximately 10% of electricity can be saved if you set the temperature 1°C higher in cooling operation or 2°C lower in heating operation than the desired temperature.

### Troubleshooting



- ION indicator on the indoor unit is blinking. ➤ Press ION button twice. If the indicator is still blinking, please consult the dealer.
- Indoor fan stops occasionally during Automatic Fan Speed setting. ➤ This is an advanced feature that helps to remove smell from the surrounding area during operation.
- Indoor fan stops occasionally during heating operation. ➤ To avoid unintended cooling effect.

■ Operation Details

**TIMER**

- Use the ON timer to turn on the air conditioner at the desired time. This will give you a cooling or warming environment, e.g. when you return from work or wake up.
- When the ON timer is set, operation will start up to 35 minutes before the actual set time.
- Use the OFF timer to stop the air conditioner operation at the desired time. This can save electricity while you are going out or sleeping.
- The set timer will repeat daily once it is set.
- If there is a power failure, you can press SET button to restore the previous setting once the power is resumed.
- If the timer is cancelled, you can restore the previous setting by pressing SET button.

**CHECK**

- When there is error, the unit stops its operation and timer indicator blinks.

1. Press for 5 seconds.

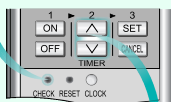

2. Browse for respective error code, where "beep" sounds are heard.
3. Turn off the power supply and call authorized distributor.

Note:  
Press the 'Reset' button to quit checking.

Unit might operate with limited function depending on error found.  
(Operation starts, 4 "beep" sounds are heard)

# HOW TO OPERATE

## Timer

**1** Select ON or OFF timer.

**2** Set the desired time.

**3** Confirm the setting.

**CANCEL** Cancel the selected timer.

- Ensure the clock on the remote control has been set correctly.
- You could use the ON and OFF timers at the same time.
- To cancel either the ON or OFF timer, press **ON** or **OFF**, then press **CANCEL**.



**Hint**

- Press **CLOCK** more than 10 seconds to change the time format from 24 hours to AM/PM format.
- For your convenience, you could set the air conditioner to operate automatically by using both ON and OFF timer.



**Troubleshooting**

- **TIMER** indicator always on. ➤ Timer is activated and the setting will repeat itself daily.
- **POWER** indicator is blinking 35 minutes before ON timer is activated. ➤ The unit is determining the operation mode by sensing the room temperature. This happens when it has been set to AUTO operation mode.

## CARE & CLEANING



**Switch off the power supply before cleaning**

### FRONT PANEL

Raise and pull to remove.  
Wash and dry.

### AIR FILTER

Vacuum, wash and dry.

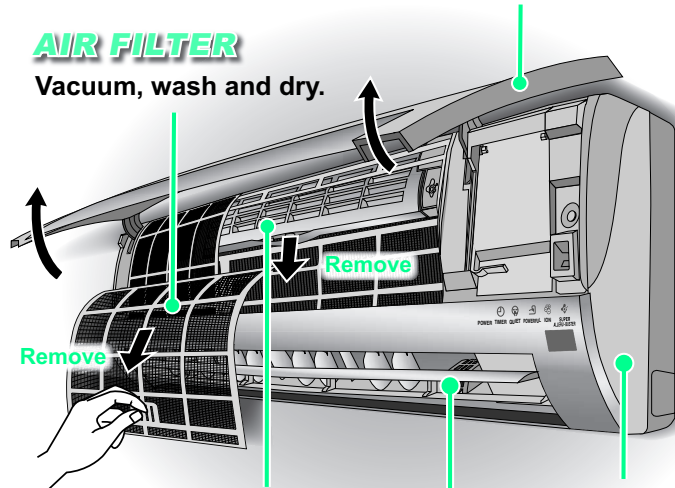

### SUPERSONIC AIR PURIFYING DEVICE

Vacuum the super alleru-buster filter.

### INDOOR UNIT

Wipe gently.

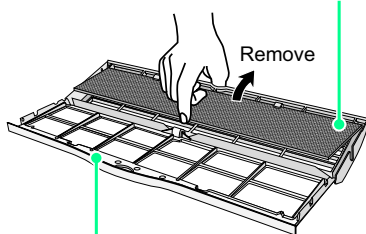

Vacuum, wash and dry the frame.

### IONIZER

Clean with cotton bud.

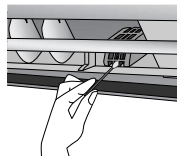

### Washing Instructions

- Do not use benzene, thinner or scouring powder.
- Use soaps or neutral household detergent ( $\approx$  pH7) only.
- Do not use water with temperature higher than 40°C.

### INDOOR UNIT

- Wipe the unit gently with a soft, dry cloth.

### AIR FILTER

- It is recommended to clean the air filters once every 2 weeks.
- Purchase the replacement filter if it is damaged.

Part no.: CWD001144

### SUPER ALLERU-BUSTER

- It is recommended to clean the filter every 6 months.
- Replace the filter every 3 years or purchase the replacement filter if it is damaged.

Part no.: CZ-SA13P

### IONIZER

- It is recommended to clean the ionizer every 6 months.

### Preparation for extended Non-operation

- Operate the unit for 2~3 hours using ion operation to dry the internal parts.
- Turn off the power supply.
- Remove the remote control batteries.

### Pre-season Inspection

- This inspection is recommended before operating the air conditioner at every season.
- Check if the remote control batteries needed to be replaced.
- Ensure there is no obstruction at all air intake and outlet vents.
- After the start of operation for 15 minutes, it is normal if the temperature differences between air intake and outlet vents at indoor unit is:-

Operation	Temperature
Cooling	$\geq 8^{\circ}\text{C}$
Heating	$\geq 14^{\circ}\text{C}$

### Hints



- Clean the filter regularly as dirty filters will cause unpurified air, low cooling or heating capacity, unpleasant smells and higher energy consumption.
- The unit will become dirty and the performance of the unit will decrease after used for several seasons. Please consult an authorized dealer to perform seasonal inspections in addition to regular cleaning.
- This air conditioner is equipped with a built-in surge protective device. However, in order to further protect your air conditioner from being damaged by abnormally strong lightning activity, you may switch off the power supply.

## 9.2. CS-E18DKRW CS-E21DKRS

### ■ Definition

To prevent personal injury, injury to others and property damage, the following instructions must be followed.

Incorrect operation due to failure to follow instructions will cause harm or damage, the seriousness of which is classified as below:

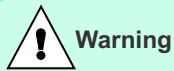

#### Warning

This sign warns of death or serious injury.



#### Caution

This sign warns of injury or damage to property.

The instructions to be followed are classified by the following symbols:



This symbol denotes an action that is PROHIBITED.



These symbols denote actions that are COMPULSORY.

### Safety Regulation

The appliance is not intended for use by young children or infirm person without supervision. Young children should be supervised to ensure that they do not play with the appliance.

Thank you for purchasing Panasonic Air Conditioner

## SAFETY PRECAUTIONS

### Installation Precautions

#### Warning

Do not install, remove and reinstall the unit by yourself.

- Improper installation will cause leakage, electric shock or fire. Please consult an authorized dealer or specialist for the installation work.

#### Caution



- This air conditioner must be earthed. Improper grounding will cause electric shock.
- Ensure that the drainage piping is connected properly. Otherwise, water will leak.
- Current leakage protection equipment must be installed. Otherwise, electric shock or fire may occur.



- Do not install the unit in a potentially explosive atmosphere.

### Operation Precautions

#### Warning



- Do not share power outlet.
- Do not modify power cord.
- Do not use an extension cord.
- Do not operate with wet hands.
- Do not insert finger or other objects into the indoor or outdoor unit.
- Do not attempt to repair the unit by yourself.
- Do not use rechargeable (Ni-Cd) batteries.
- Keep the remote control away from infants and small children to prevent them from accidentally swallowing the batteries.



- Use specified supply cord.
- If the supply cord is damaged or needed to be replaced, it must be replaced by the manufacturer or its service agent or a similarly qualified person in order to avoid a hazard.
- Remove the batteries if the unit is not going to be used for a long period of time.
- New batteries of the same type must be inserted following the polarity stated to prevent malfunction of the remote control.



- In case of emergency or abnormal condition (burnt, smell, etc) occurs, turn off the power supply.

#### Caution



- Do not wash the unit with water, benzene, thinner or scouring powder.
- Do not use for other purposes such as preservation of food.
- Do not use any combustible equipment at airflow direction.
- Do not sit or place anything on the indoor or outdoor unit.
- Do not expose directly to cold air for a long period.



- Ventilate the room regularly.
- Pay attention as to whether the installation rack is damaged after long period of usage.



- Switch off the power supply before cleaning or servicing.
- Turn off the power supply if the unit is not used for a long period of time.

### Operation Condition (°C)

Use this air conditioner under the following temperature range.

DBT: Dry Bulb Temperature WBT: Wet Bulb Temperature	Indoor		Outdoor	
	DBT	WBT	DBT	WBT
Maximum Temperature (COOL)	32	23	43	26
Maximum Temperature (HEAT)	30	-	24	18
Minimum Temperature (COOL)	16	11	-5	-
Minimum Temperature (HEAT)	16	-	-5	-6

Note: The illustrations in this manual are for explanation purposes only and may differ from the actual unit. It is subjected to change without notice for future improvement.

## PRODUCT OVERVIEW

### Indoor Unit

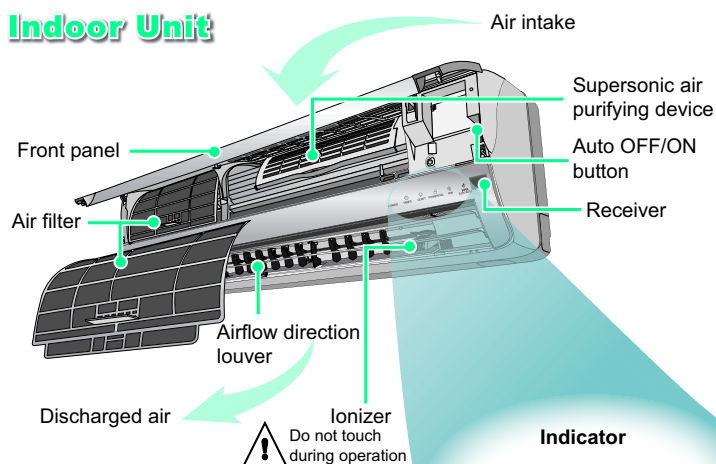

### Outdoor Unit

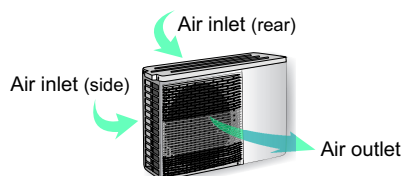

### Remote Control

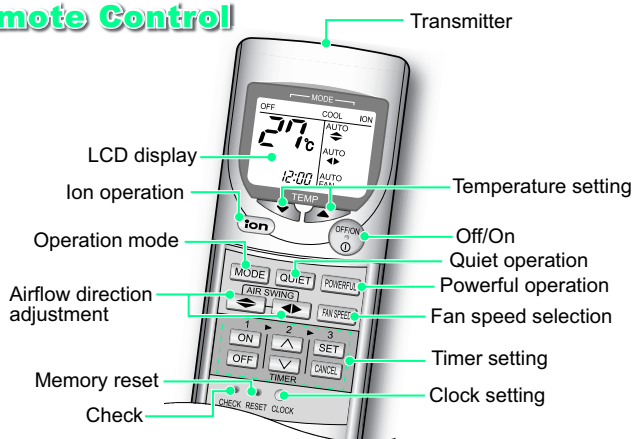

### About

#### Remote Control Preparation

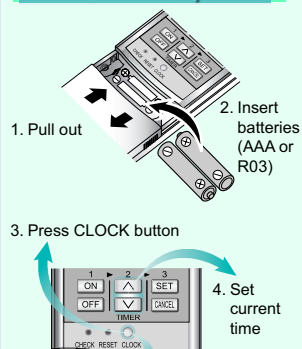

5. Press again to confirm
- Timer operation will be based on current time set.
  - The batteries can be used for approximately 1 year.
  - The batteries must be recycled or disposed of properly.

#### Remote Control Signal

- Make sure it is not obstructed.
- Maximum distances: 10m.
- Certain fluorescent lights may interfere with signal transmission. Consult your dealer.

#### Auto OFF/ON Button

- To operate the unit if the remote control is misplaced or malfunctioning.

Action	Operation mode
Press once	Automatic Operation
Press until "beep" sound and release.	Cooling Operation
Press until "beep" sound and release. Press again until "beep-beep" sound and release.	Heating Operation

- To OFF, press again the Auto OFF/ON button.

### Troubleshooting

- Operation delayed for few minutes after restart. ➤ This is a normal self protection control.
- Sound like water flowing during operation. ➤ Caused by refrigerant flow inside.
- Mist emerges from indoor unit. ➤ Condensation effect due to cooling process.
- Noisy during operations. ➤ Installation work could be slanted or front panel didn't close properly.
- Remote control/display does not work. ➤ Check whether batteries are correctly inserted or need replacement.
- The unit cannot operate. ➤ Check either circuit breaker is tripped or timer is used correctly.
- Outdoor unit emits water/steam. ➤ Condensation or evaporation happens at piping surface.



# HOW TO OPERATE

## Auto, Heat, Cool, Dry

### ■ Operation Details

#### AUTO - Automatic Operation

- The unit will automatically select the operation mode according to the setting, outdoor and room temperature. During operation mode selection, power indicator blinks. For every 30 minutes, the operation mode is reselected.

#### HEAT - Heating Operation

- Enables you to enjoy the warming effect at your preferred setting temperature.
- For cold air prevention, air might not blow out immediately and power indicator blinks when operation starts.
- Also operates in defrost mode (maximum 10 minutes) where by the power indicator blinks. The melted frost is drained at outdoor unit and indoor fan is stopped.

#### COOL - Cooling Operation

- Enables you to enjoy the cooling effect at your preferred setting temperature.

#### DRY - Soft Dry Operation

- Enables you to set the desired temperature at low fan speed which provides you with the dehumidifying surroundings.

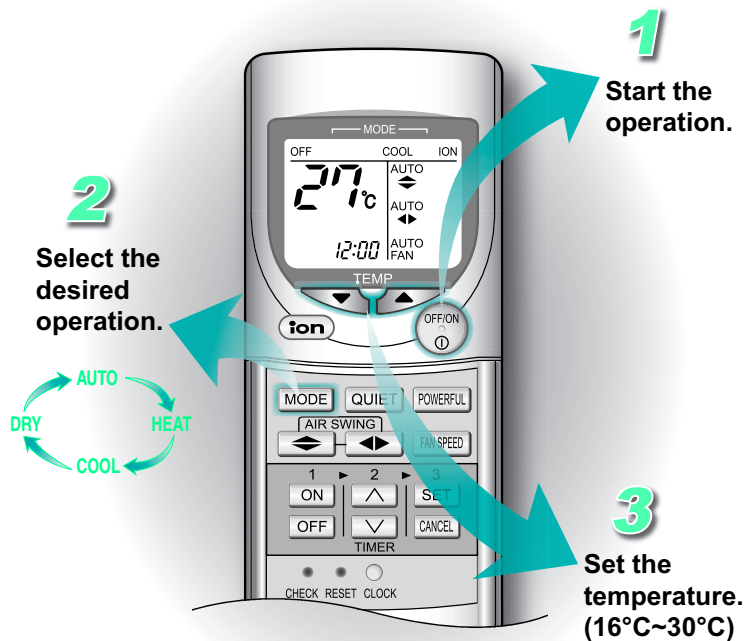

- Supersonic air purifying device (super alleru-buster) operates automatically while the air conditioner is switched on.
- Powerful, Quiet and Ion operations could be activated in all operation modes.
- Press button again to stop the operation.

#### Hint

- To save electricity, close the curtains when using air conditioner to prevent sunlight and heat from coming in.

#### Troubleshooting

- |  |   |
|--|---|
| <ul style="list-style-type: none"> <li>• The room has a peculiar odour.</li> </ul>                     | <ul style="list-style-type: none"> <li>➤ This may be a damp smell emitted by the wall, carpet, furniture or clothing in the room.</li> </ul>  |
| <ul style="list-style-type: none"> <li>• Air conditioner does not cool or heat efficiently.</li> </ul> | <ul style="list-style-type: none"> <li>➤ Ensure the temperature has been set correctly.</li> <li>➤ Ensure windows and doors have been closed properly.</li> <li>➤ Ensure filters are cleaned or replaced when necessary.</li> <li>➤ Ensure inlet and outlet vents of the units have not been obstructed.</li> </ul> |

# HOW TO OPERATE

## Powerful, Quiet, Ion, Fan Speed, Air Swing

### ION

Enables ion operation.



### QUIET

Enables quiet operation.

### POWERFUL

Enables powerful operation.

### AIR SWING

Adjust the vertical or horizontal airflow direction louver.

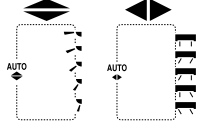

### FAN SPEED

Select fan speed.



- Powerful and Quiet operations could not be activated at the same time.
- Powerful, Quiet and Ion operations could be cancelled by pressing the respective button again.

## Operations Details

### POWERFUL

- To achieve setting temperature quickly.

### QUIET

- To provide a quiet environment.

### ION

- To provide fresh air effect by producing negative ions.
- Ion operation could be activated independently.
- Press  button to stop the operation.

### FAN SPEED

- To provide you with the various fan speed selections.
- There are 5 levels of fan speed in addition to automatic fan speed.
- Automatic fan speed:  
The speed of the indoor fan is automatically adjusted according to the operation.

### AIR SWING

- To ventilate air in the room.
- There are 5 selections in addition to automatic vertical air flow direction.
- If automatic vertical airflow direction has been set, the louver swings up and down automatically.

- To ventilate air in the room.
- There are 5 selections in addition to automatic horizontal air flow direction.
- If automatic horizontal airflow direction has been set, the louver swings left and right automatically.

- Please do not adjust the vertical and horizontal airflow direction louver manually.

### Hints



- If you wish to have the cool air blowing directly on you, set the airflow direction downward but not for an excessive length of time, as it may harm your health.
- Approximately 10% of electricity can be saved if you set the temperature 1°C higher in cooling operation or 2°C lower in heating operation than the desired temperature.

### Troubleshooting



- ION indicator on the indoor unit is blinking. ➤ Press ION button twice. If the indicator is still blinking, please consult the dealer.
- Indoor fan stops occasionally during Automatic Fan Speed setting. ➤ This is an advanced feature that helps to remove smell from the surrounding area during operation.
- Indoor fan stops occasionally during heating operation. ➤ To avoid unintended cooling effect.

■ Operation Details

**TIMER**

- Use the ON timer to turn on the air conditioner at the desired time. This will give you a cooling or warming environment, e.g. when you return from work or wake up.
- When the ON timer is set, operation will start up to 35 minutes before the actual set time.
- Use the OFF timer to stop the air conditioner operation at the desired time. This can save electricity while you are going out or sleeping.
- The set timer will repeat daily once it is set.
- If there is a power failure, you can press SET button to restore the previous setting once the power is resumed.
- If the timer is cancelled, you can restore the previous setting by pressing SET button.

**CHECK**

- When there is error, the unit stops its operation and timer indicator blinks.

1. Press for 5 seconds.

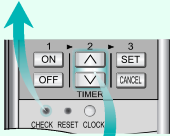

2. Browse for respective error code, where "beep" sounds are heard.
3. Turn off the power supply and call authorized distributor.

Note:  
Press the 'Reset' button to quit checking.

Unit might operate with limited function depending on error found.  
(Operation starts, 4 "beep" sounds are heard)

# HOW TO OPERATE

## Timer

**1**

Select ON or OFF timer.

**2**

Set the desired time.

**3**

Confirm the setting.

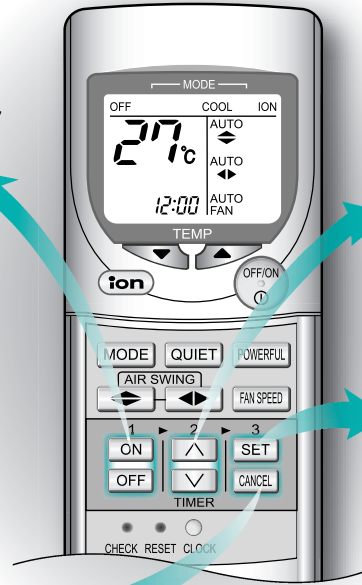

### CANCEL

Cancel the selected timer.

- Ensure the clock on the remote control has been set correctly.
- You could use the ON and OFF timers at the same time.
- To cancel either the ON or OFF timer, press **ON** or **OFF**, then press **CANCEL**.



**Hint**

- Press **CLOCK** more than 10 seconds to change the time format from 24 hours to AM/PM format.
- For your convenience, you could set the air conditioner to operate automatically by using both ON and OFF timer.



**Troubleshooting**

- **TIMER** indicator always on. > Timer is activated and the setting will repeat itself daily.
- **POWER** indicator is blinking 35 minutes before ON timer is activated. > The unit is determining the operation mode by sensing the room temperature. This happens when it has been set to AUTO operation mode.

## CARE & CLEANING



**Switch off the power supply before cleaning**

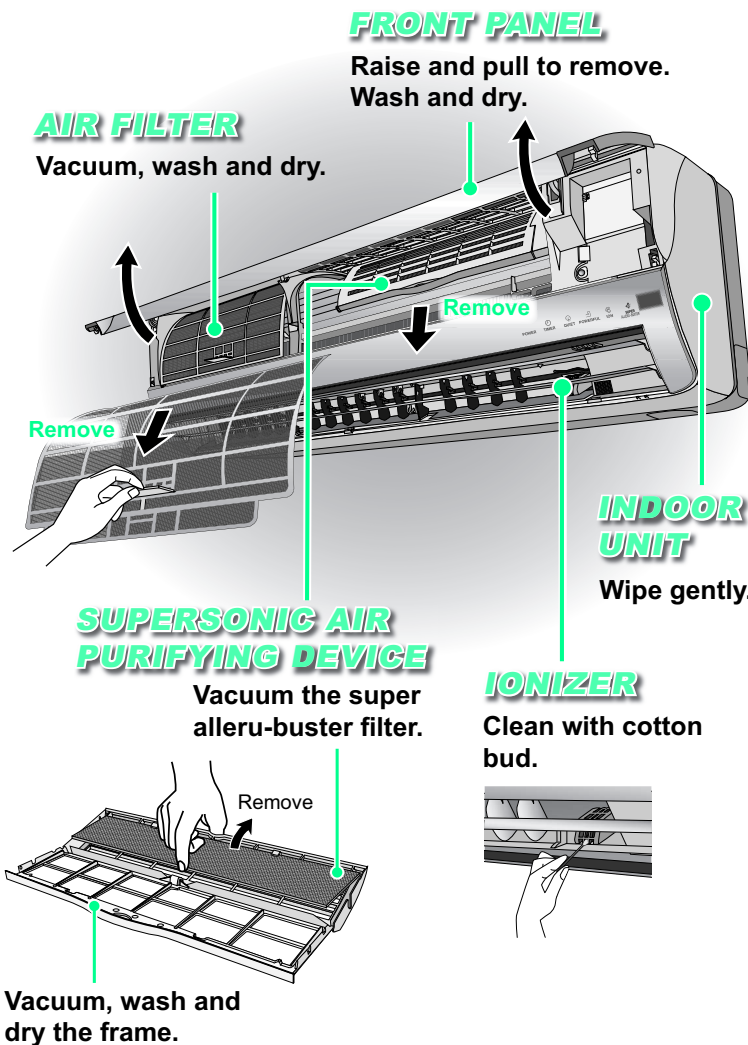

### Washing Instructions

- Do not use benzene, thinner or scouring powder.
- Use soaps or neutral household detergent ( $\approx$  pH7) only.
- Do not use water with temperature higher than 40°C.

### INDOOR UNIT

- Wipe the unit gently with a soft, dry cloth.

### AIR FILTER

- It is recommended to clean the air filters once every 2 weeks.
- Purchase the replacement filter if it is damaged.

Part no.: CWD001137 (Left)

CWD001138 (Right)

### SUPER ALLERU-BUSTER

- It is recommended to clean the filter every 6 months.
- Replace the filter every 3 years or purchase the replacement filter if it is damaged.

Part no.: CZ-SA13P

### IONIZER

- It is recommended to clean the ionizer every 6 months.

### Preparation for extended Non-operation

- Operate the unit for 2~3 hours using ion operation to dry the internal parts.
- Turn off the power supply.
- Remove the remote control batteries.

### Pre-season Inspection

- This inspection is recommended before operating the air conditioner at every season.
- Check if the remote control batteries needed to be replaced.
- Ensure there is no obstruction at all air intake and outlet vents.
- After the start of operation for 15 minutes, it is normal if the temperature differences between air intake and outlet vents at indoor unit is:-

Operation	Temperature
Cooling	$\geq 8^{\circ}\text{C}$
Heating	$\geq 14^{\circ}\text{C}$

### Hints



- Clean the filter regularly as dirty filters will cause unpurified air, low cooling or heating capacity, unpleasant smells and higher energy consumption.
- The unit will become dirty and the performance of the unit will decrease after used for several seasons. Please consult an authorized dealer to perform seasonal inspections in addition to regular cleaning.
- This air conditioner is equipped with a built-in surge protective device. However, in order to further protect your air conditioner from being damaged by abnormally strong lightning activity, you may switch off the power supply.