



Installation and servicing instructions  
MODEL **DIA 20 MFFICE**  
Type C  
with Sealed Combustion Chamber  
G.C. NUMBER 4711603

---

Produced by M.T.S. - Italy

This boiler is for use with natural gas only.

**LEAVE THIS INSTRUCTIONS  
ADJACENT TO THE GAS METER**

MTS (GB) LIMITED  
MTS Building, Hughenden Avenue, High Wycombe  
Bucks HP 13 5FT  
Telephone (0494) 459711 - Fax (0494) 459775

# TABLE OF CONTENTS

Sect.	Subject	Page No.	Sect.	Subject	Page No.
<b>1</b>	<b>GENERAL INFORMATION</b>		<b>6.13</b>	Burner and injectors	25
1.1	Overall view	2	6.14	Insulations panel	26
1.2	Technical data	3	6.15	Gas modulator cartridge	26
1.3	Available pump head	4	6.16	Gas modulator coil	27
1.4	Flue pipes optional extras	4	6.17	On-off operator coils	27
1.5	Design principles and operating sequence	4	6.18	Gas valve	27
			6.19	Removing the fan	27
			6.20	Air pressure switch	28
<b>2</b>	<b>GENERAL REQUIREMENTS</b>		6.21	Main heat exchanger	28
2.1	Related documents	6	6.22	Automatic air purger	29
2.2	Location of appliance	6	6.23	Pump	29
2.3	Flue system	6	6.24	Main circuit flow switch	30
2.4	Gas supply	6	6.25	Temperature pressure gauge	30
2.5	Air supply	7	6.26	Removing diverter valve	31
2.6	Water circulation	7	6.27	Secondary exchanger	31
2.7	Domestic water	8	6.28	Expansion vessel	31
2.8	Electrical supply	8	6.29	Safety valve	32
<b>3</b>	<b>INSTALLATION</b>		<b>7</b>	<b>FAULT FINDING</b>	
3.1	Delivery	9	7.1	Total check system	33
3.2	Measurements for installing the appliance	9	7.2	Special defects	33
3.3	Unpacking the boiler	10	7.2.1	Water leaks	33
3.4	Positioning of the boiler	10	7.2.2	Difficulty in lighting the burner	33
3.5	Mounting the flue exhaust pipes	11	7.2.3	Incorrect combustion	34
3.6	Flue terminal guard	13	7.2.4	Traces of gas or exhaust flues	34
3.7	Electrical connections	13	7.3	Installation of the TCS	34
			7.4	Fault finding	34
			7.5	Fault finding without the utilization of the total check system	51
<b>4</b>	<b>COMMISSIONING</b>		7.5.1	Appliance completely shut down	51
4.1	Electrical installation	15	7.5.2	Appliance doesn't attempt to ignite the burner ( no sparks )	52
4.2	Gas supply installation	15	7.5.3	Appliance fail frequently ignition with consequent lockout ( red light on the reset push button )	53
4.3	Filling the d.h.w. system	15	7.5.4	Fault on "hot water-space heating" switching	54
4.4	Initial filling of the system	15			
4.5	Setting the system pressure	16			
4.6	Lighting the boiler	16			
4.7	Checking the full sequence control	16			
4.8	Testing the d.h.w. system flow	16			
<b>5</b>	<b>MAINTENANCE</b>		<b>8</b>	<b>ELECTRIC DIAGRAMS</b>	
5.1	General	17	8.1	Electrical connection	55
5.2	Recommended routine maintenance	17	8.2	Functional flow connection	56
<b>6</b>	<b>SERVICING INSTRUCTIONS</b>		<b>9</b>	<b>SHORT SPARE PARTS LIST</b>	57
6.1	Replacement of parts	18	.	Control panel	
6.2	To gain access	18	.	Residual head of circulator	
6.3	To drain the main circuit of the boiler	19	.	Regulating heating power for Natural Gas (G20)	
6.4	To drain the d.h.w. circuit of the boiler	19	.	Regulating heating power for Butane Gas (G30)	
6.5	Setting gas pressure	19	.	Regulating heating power for Propane Gas (G31)	
6.6	Overheat thermostat	21			
6.7	Removing ignition electrodes	21			
6.8	Removing flame sensor	22			
6.9	Removing d.h.w. and c.h.w. potentiometers	23			
6.10	Removing d.h.w. sensor probe	24			
6.11	Removing c.h.w. sensor probe	24			
6.12	Microswitches on diverter valve	25			

---

---

*Dear customer,*

*Thank you for choosing a ARISTON combination boiler.*

*We guarantee that your boiler is a reliable and technically sound product.*

*This Owner's manual provides detailed instructions and recommendations for proper installation, use and maintenance.*

*Remember to keep this manual in a safe place for future reference i.e. by the gas meter.*

*Your local MTS Servicing Centre is at your complete disposal for all your requirements.*

**MTS (GB) LIMITED**



## **GUARANTEE**

The guarantee on this appliance is valid for 12 months from the first day of start up.

Repairs to the electric, hydraulic or gas circuits may be carried out only by your local authorized MTS Servicing Centre.

*Despite every attempt has been made to avoid errors of any kind in this Owner's Manual, the Management invites customers to inform of any inaccuracies which they may find. This will help to improve our service.*

## IMPORTANT INSTRUCTIONS

Read the instructions and recommendations in this owner's manual carefully to ensure proper installation, use and maintenance of the appliance.

Keep this owner's manual in a safe place.

You may need it for your own reference while our Servicing Centre technicians or your installer may need to consult it in the future.

## WARNING

This appliance is designed to produce hot water. It must be connected to a central heating system or to hot water mains system suited to its specifications and capacity.

This appliance **MUST BE USED ONLY** for the purpose for which it is designed.

The manufacturer declines all liability for damage caused by improper or negligent use.

**BEFORE CONNECTING** the appliance check that the information shown on the data plate and the table on pages 4-5 comply with the electric, water and gas mains of your home.

You will find the data plate on the control panel.

The gas with which this appliance operates is also shown on the label at the bottom of the boiler.

**DO NOT** install this appliance in a damp environment or close to equipment which spray water or other liquids.

**DO NOT PLACE** objects on the appliance.

**DO NOT ALLOW** children or inexperienced persons to use the appliance without supervision.

If you smell gas in the room, **DO NOT TURN ON** light switches, use the telephone or any other object which might cause sparks.

Open doors and windows immediately to ventilate the room.

Shut the gas mains tap ( on the gas meter ) or the valve of the gas cylinder and call your Gas Supplier immediately.

If you are going away for a long period of time, remember to shut the mains gas tap or the gas cylinder valve.

**ALWAYS DISCONNECT** the appliance either by unplugging it from the mains or turning off the mains switch before cleaning the appliance or carrying out maintenance.

**IN THE CASE OF FAULTS OR FAILURE**, switch off the appliance and turn off the gas tap. Do not tamper with the appliance.

For repairs, call your local Authorized Servicing Centre and request the use of original spare parts.

For in guarantee repairs contact MTS (GB) LIMITED

**NEVER** block the ventilation outlet of the compartment in which the boiler is installed with rags or paper.

**CHECK** the following at least once a year:

- 1 -Check the seal of water connections, replacing the gaskets if necessary.
- 2 -Check the seal of the gas connections, replacing the gaskets if necessary.
- 3 -Check the general condition of the appliance and of the combustion chamber visually
- 4 -Visual check of the combustion: clean burners if necessary.
- 5 -With reference to point 3, dismount and clean the combustion chamber if necessary.
- 6 -With reference to point 4, dismount and clean the injectors if necessary.
- 7 -Visual check of the primary heat exchanger:
  - check for overheating of the exchangers fins;
  - clean the fume side of the exchanger if necessary.
- 8 -Regulate the gas pressure, ignition pressure, partial flame, maximum flame.
- 9 -Check proper operation of the heating safety system:
  - maximum safety temperature;
  - maximum safety pressure.
- 10 -Check the proper operation of the gas safety system:
  - gas or flame safety device;
  - gas valve safety device.
- 11 -Check that the electric connections have been made in compliance with the instructions shown in the owner's manual.
- 12 -Check the efficiency of the hot water supply ( flow and temperature ).
- 13 -General operating check of the appliance.
- 14 -Check room ventilation.
- 15 -Check the exhaust system for the combustion products.

**FAILURE  
TO FOLLOW THE  
ABOVE INSTRUCTIONS  
MAY COMPROMISE  
THE SAFETY OF THE  
APPLIANCE**

# GENERAL INFORMATION

## OVERALL VIEW

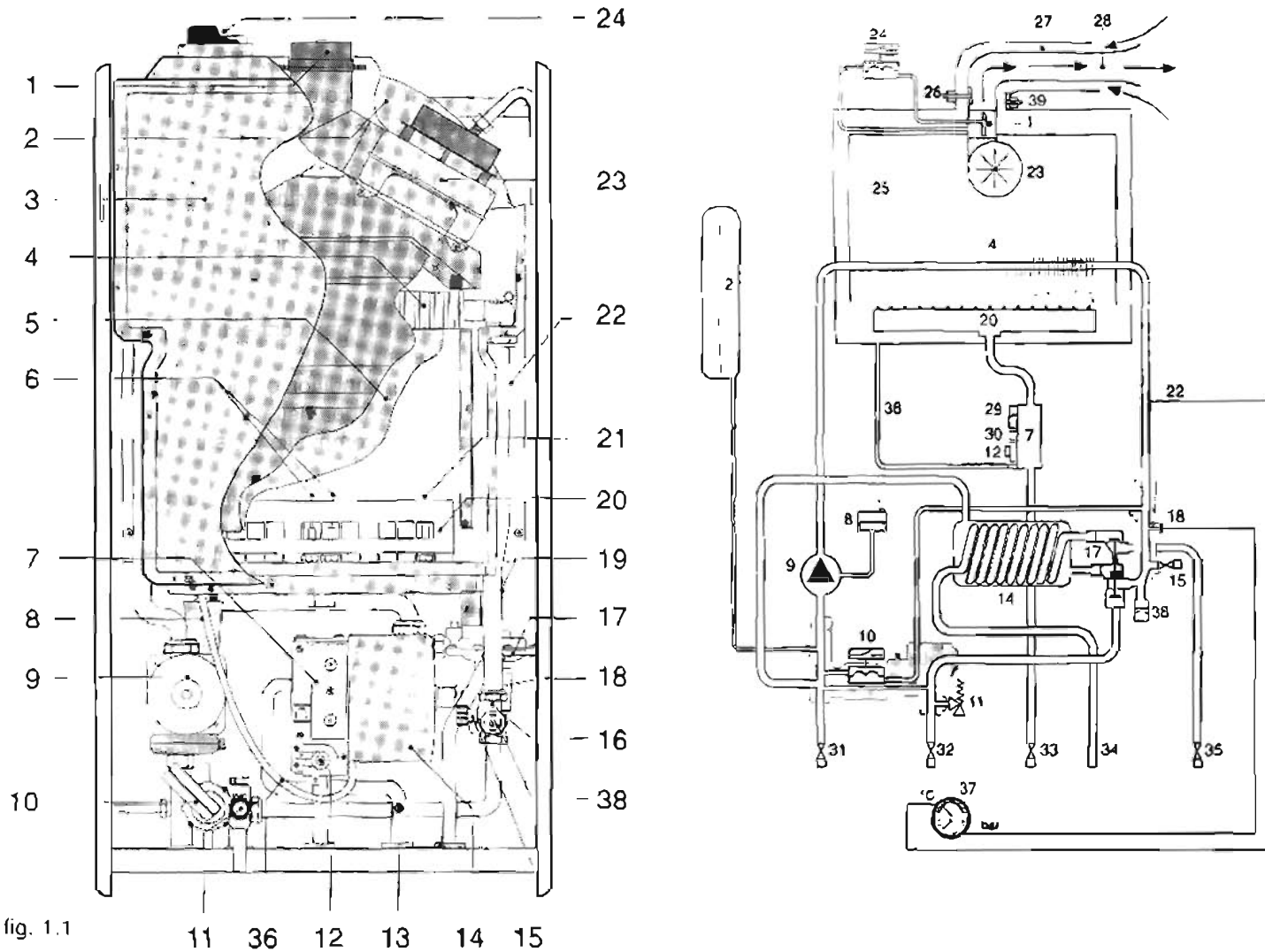

fig. 1.1

- 1 - Venturi device
  - 2 - Expansion vessel
  - 3 - Sealed combustion chamber
  - 4 - Main heat exchanger
  - 5 - Combustion chamber insulation panel
  - 6 - Ignition electrodes
  - 7 - Gas valve
  - 8 - Automatic air release valve
  - 9 - Pump
  - 10- Main circuit flow switch
  - 11 - Safety valve
  - 12- Gas modulator
  - 13- D.h.w. temperature probe
  - 14- Secondary exchanger
  - 15- C.h. drain cock
  - 16- Hydraulic multi-connections
  - 17- Divertor valve
  - 18- Heating temperature probe
  - 19- Thermometer probe
  - 20- Main burner
  - 21- Detection electrode
  - 22- Overheat thermostat probe
  - 23- Fan
  - 24- Air pressure switch
  - 25- Combustion chamber
  - 26- Flue gas sampling point
  - 27- Air intake
  - 28- Flue outlet
  - 29- Pressure test point for measuring outlet pressure at the gas valve<sup>(1)</sup>
  - 30- Pressure test point for measuring inlet pressure at the gas valve<sup>(1)</sup>
  - 31- C.h.w. ( central heating water) return
  - 32- C.h.w. flow
  - 33- Gas inlet
  - 34- D.h.w. ( domestic hot water) outlet
  - 35- D.w. inlet
  - 36- Compensation pipe
  - 37- Water pressure/temperature gauge
  - 38- Pump pressure switch
  - 39- Air intake temperature sampling point
- (1) Gas valve components.

# General information

## TECHNICAL DATA

### Model DIA 20 MFFICE

The ARISTON DIA 20 MFFICE is a combined central heating (c.h.) and domestic hot water (d.h.w.) appliance.

It is produced as a room sealed category appliance suitable for wall mounting applications only.

This boiler is suitable only for sealed systems.

Heating input	max	25.6 kW	87364 Btu/h	<b>GAS REQUIREMENTS</b>			
Heating input	min	11.0 kW	37539 Btu/h	Gas rate	max	2.72 m <sup>3</sup> /h	96.0 h <sup>3</sup> /h
Heating output	max	23.1 kW	78491 Btu/h	Gas rate	min	1.1 m <sup>3</sup> /h	38.8 ft <sup>3</sup> /h
Heating output	min	9.2 kW	31396 Btu/h	Inlet pressure		20 mbar	7.8 in w.g.
<b>CENTRAL HEATING</b>				Burner pressure ( Natural gas )	max	12.3 mbar	4.8 in w.g.
Operating temperature	max	87 °C		Burner pressure ( Natural gas )	min	2.0 mbar	0.8 in w.g.
Operating temperature	min	45 °C		Burner injectors		13 x 1.25	
Working pressure	max	2.5 bar	36.25 p.s.i.	<b>COMPONENT DETAILS</b>			
Water content		2.7 lts	0.6 gals.	Gas control valve		SJT 837 TANDEM	
Built-in expansion vessel - Total capacity		7 lts	1.53 gals.	Burner		Atmospheric steel - POLIDORO	
Built-in expansion vessel - Pre-charge pressure		1 bar	14.5 p.s.i.	<b>ELECTRICAL DATA</b>			
Available head at 1000 lts./h ( 220 gals./h )		1.45 m w.g.	57.09 ins w.g.	Electrical supply		230 V	
Temp. difference for flow and return		20 °C		Frequency		50 Hz	
Flow rate of water through the appliance		1000 lts./h	219.3 gals./h	Power consumption		150 W	
Max permissible cold water capacity without additional expansion vessel <sup>(1)</sup>		70 lts./h	15.3 gals./h	Internal fuse rating		FAST 2 AT	
<b>DOMESTIC HOT WATER</b>				<b>CONNECTIONS</b>			
Working pressure	max	6 bar	87 p.s.i.	Gas connection		15 mm o.d.	
Working pressure	min	0.2 bar	2.9 p.s.i.	C.h. flow		22 mm o.d.	
Water content		0.30 lts	0.08 gals.	C.h. return		22 mm o.d.	
Flow rate	min	2.6 lts./min	0.54 gals./min	D.c.w. inlet		15 mm o.d.	
Flow rate	30 °C rise	11.0 lts./min	2.4 gals./min	D.h.w. outlet		15 mm o.d.	
Flow rate	35 °C rise	9.5 lts./min	2.1 gals./min	Safety discharge pipe		15 mm o.d.	
Flow rate	40 °C rise	8.3 lts./min	1.8 gals./min	<b>FLUE PIPES SPECIFICATIONS</b>			
				Outer diameters	Flue exhaust pipe	60 mm	2.36 ins
				Outer diameters	Air intake pipe	100 mm	3.93 ins
				Standard length		1000 mm	39.38 ins
				Maximum length <sup>(2)</sup>		3000 mm	118.1 ins
				<b>OTHER SPECIFICATIONS</b>			
				Height		895 mm	35.24 ins
				Width		480 mm	18.90 ins
				Depth		360 mm	14.17 ins
				Dry weight		46 Kg	101.4 lb

(1) If required an external expansion vessel can be fitted

(2) Using one or more horizontally elongated flue pipes kits (see sect. 7.4)

# General information

## 1.3 AVAILABLE PUMP HEAD

The curve at pag.52 shows the water pressure ( head ) available to the central heating ( c.h. ) circuit as a function of flow; the load loss of the appliance has already been subtracted.

## 1.4 FLUE PIPE OPTIONAL EXTRAS

For a full report about flue pipe optional extras, please consult "flue pipe accessories".

## 1.5 DESIGN PRINCIPLES AND OPERATING SEQUENCE

### Water system design

The basic purpose of a boiler is to generate heat through the combustion of gas and to direct the heat through a water circuit.

A combination-type appliance allows the heat to be used either for heating the environment or for heating hot water for domestic use.

### Main water circuit

This is an internal water circuit in the appliance which passes through the main heat exchanger and absorbs heat directly from the combustion of gas. The water in this circuit is the same water that is circulated by the pump and flows through the c.h. system.

The direction of the water in the main water circuit can be changed by a diverter valve. The main water circuit is connected to the c.h. circuit during operation with the c.h. system ( see fig. 1.2 )

When d.h.w. is required, the main water circuit is directed through the d.h.w. heat exchanger via the diverter valve ( see fig. 1.3 ).

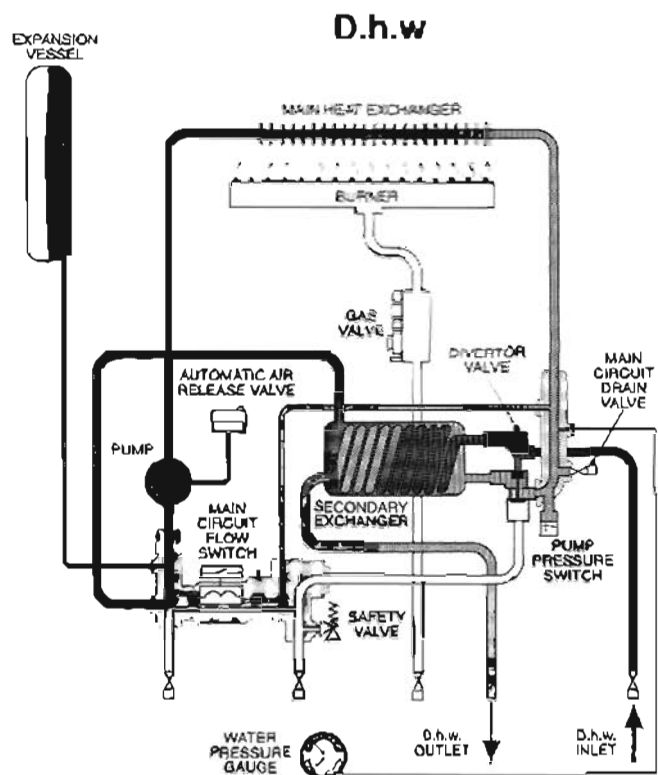

fig. 1.3

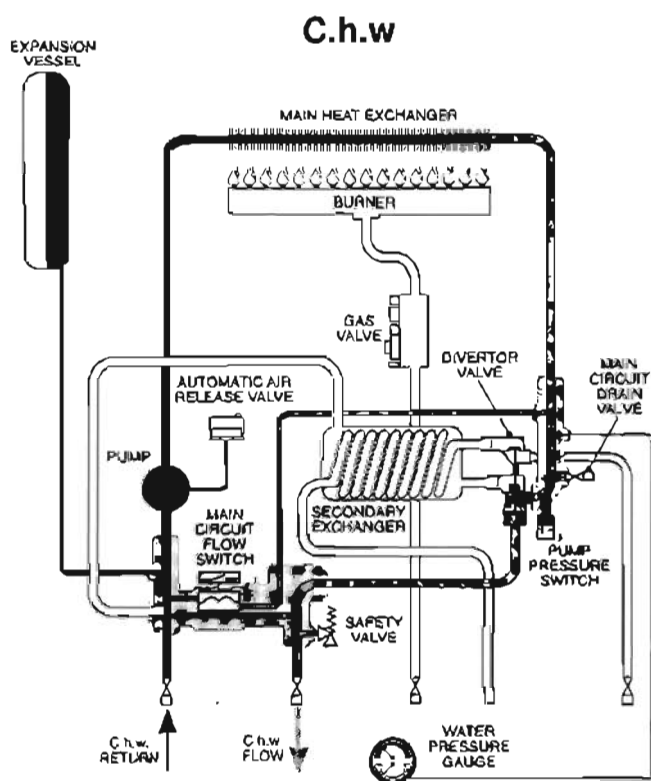

fig. 1.2

### Safety device

If the flow rate in the main water circuit is insufficient, the flow switch on main water circuit disconnects the supply to the full sequence control p.c.b.

In this case the boiler is turned off in order to prevent damage.

An overheat thermostat disconnects the two ON-OFF operators on the gas valve; as a result, the burner is shut down and the shut down warning light will appear.

A safety valve is provided to relieve excess pressure from the main circuit.

The appliance is equipped with a safety system ( vent device and air pressure switch ) which detects the velocity of the exhaust flues.

If the air pressure switch does not detect the correct velocity, the burner will shut down.

### Operating sequence on central heating mode

The function switch must be set on position III.

The water in the main circuit is sent to the c.h. system when the diverter valve is in the c.h. position.

In this configuration, the diverter is in the normal position and the d.h.w. heat exchanger circuit is cut out.

The appliance is controlled by an electronic thermostat. The water delivery temperature can be adjusted from 35° to 85° C.

---

## General information

---

When heat is required a command starts the fan, which switches the air pressure switch.

After the air pressure switch has been switched, the combustion chamber is purged of any residual unburned gasses for a few seconds. Next, the lighting cycle begins with a spark from the ignition electrode; at the same time, electrical power is fed to the two ON-OFF operators on the gas valve.

If the flame detection electrode does not sense the flame within 10 seconds from the beginning of the cycle, the full sequence control p.c.b. interrupts the lighting cycle, the electric spark is shut off and the power is disconnected from the two ON-OFF operators on the gas valve; as a result, the burner is shut down.

At this point, the shut down warning light appears and the reset push-button must be pressed to restart the lighting cycle.

If the detection electrode senses flame within 10 seconds from the beginning of the cycle, the full sequence control p.c.b. interrupts the electrical sparks and holds the burner alight.

At the same time, the temperature of the heating circuit is measured by the main circuit temperature probe and this temperature is compared with the value set on the c.h. temperature adjustment (III °C).

After lighting has been accomplished, the flow from the gas valve is determined by the electronic regulation p.c.b. :

-When the temperature of the circuit heating water ( c.h.w. ) is 5°C ( or more ) under the preset temperature, the appliance will supply its maximum preset power .

-When the temperature of the circuit heating water ( c.h.w. ) is just few degrees under ( <5°C ) the preset-temperature, the appliance will supply its minimum pre-set power ( that corresponds to 35% of the maximum rated power).

### D.h.w. only operation

When the function switch is set on position II, the c.h. adjustment system is deactivated, the divertor valve is actuated and the shutter closes water delivery to the d.h.w. heat exchanger. When d.h.w. is drawn from the d.h.w. system, the appliance operates in the same way as when the function switch set on position III.



## 2 GENERAL REQUIREMENTS

*This appliance must be installed by a competent installer in accordance with the 1984 Gas Safety ( installation & use ) Regulations ( as amended ).*

### 2.1 RELATED DOCUMENTS

The installation of this appliance must be in accordance with the relevant requirements of the 1984 Gas Safety ( installation & use ) Regulations, the Local Building Regulations, the current I.E.E. Wiring Regulations, the by laws of the local water undertaking, and in Scotland, in accordance with the Building Standards ( Scotland ) Regulation. Health and safety document n° 635 " Electricity at work regs. 1989 ".

Installation should also comply with the following British Standard Codes of Practice:

Low pressure pipes	BS 6891	1988
Boilers of rated input not exceeding 60 kW	BS 6798	1987
Forced circulation hot water system	BS 5449	1990
Installation of gas hot water supplies for domestic purposes ( 2 <sup>nd</sup> family gases )	BS 5546	1990
Flues	BS 5540-1	1990
Air supply	BS 5540-2	1989

### 2.2 LOCATION OF APPLIANCE

The appliance may be installed in any room or indoor area, although particular attention is drawn to the requirements of the current I.E.E. Wiring Regulations, and in Scotland, the electrical provisions of the Building Regulations applicable in Scotland, with respect to the installation of the combined appliance in a room containing a bath or shower.

**Where a room-sealed appliance is installed in a room containing a bath or shower, any electrical switch or appliance control, utilising mains electricity should be situated so that it cannot be touched by a person using the bath or shower.**

The location must permit adequate space for servicing and air circulation around the appliance ( see fig. 3.1-a and 3.1-a ).

The location must permit the provision of an adequate flue and termination.

For unusual locations special procedures may be necessary.

BS 6798-1987 gives detailed guidance on this aspect.

A compartment used to enclose the appliance must be designed specifically for this purpose.

This appliance is not suitable for outdoor installation.

### 2.3 FLUE SYSTEM

The provision for satisfactory flue termination must be made as described in BS 5440-1.

The appliance must be installed so that the flue terminal is exposed to outdoor air.

The terminal must not discharge into another room or space such as an outhouse or lean-to.

It is important that the position of the terminal allows free passage of air across at all times.

The terminal should be located with due regard for the damage or discoloration that might occur on buildings in the vicinity.

In cold and/or humid weather water vapour may condense on leaving the flue terminal.

The effect of such " steaming " must be considered.

The minimum acceptable spacing from the terminal to obstructions and ventilation openings are specified in fig. 2.1.

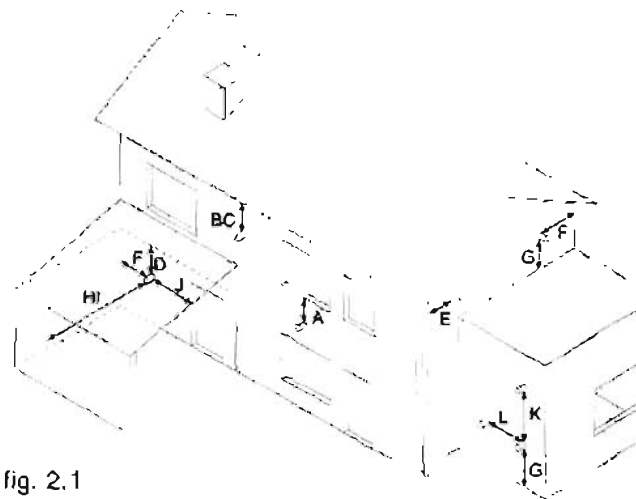

fig. 2.1

#### TERMINAL POSITION

TERMINAL POSITION	mm
A - Directly below an open window or other opening	300
B - Below gutters, solid pipes or drain pipes	75
C - Below eaves	200
D - Below balconies or car port roof	200
E - From vertical drain pipes and soil pipes	75
F - From internal or external corners	300
G - Above ground or below balcony level	300
H - From a surface facing a terminal	600
I - From a terminal facing a terminal	1200
J - From an opening in the car port ( e.g. door, window ) into dwelling	1200
K - Vertically from a terminal in the same wall	1500
L - Horizontally from a terminal in the same wall	300

### 2.4 GAS SUPPLY

The gas meter is connected to the service pipe by the local gas region contractor.

If the gas supply for the boiler serves other appliances ensure that an adequate supply is available both to the boiler and the other appliance when they are in use at same time.

Pipework must be of an adequate size. Pipes of a smaller size than the boiler inlet connection should not be used.

Installation pipes should be fitted in accordance with BS 6891-1988 and the complete installation should be tested for soundness.

# General requirements

## 2.5 AIR SUPPLY

The room in which the boiler is installed does not require a purpose provided air vent.

If installed in a cupboard or compartment, ventilation is required for cooling.

Recommendations for air supply are detailed in BS 5440-2.

The following notes are for general guidance.

The minimum effective area requirement is :

230.4 cm<sup>2</sup> / 34.9 in<sup>2</sup> at high level

230.4 cm<sup>2</sup> / 34.9 in<sup>2</sup> at low level

The figures quotes relate to the ventilation requirement if the ventilation is into a room. If the ventilation is to the outside then the above sizes can be halved.

## 2.6 WATER CIRCULATION ( Central heating )

Detailed recommendations are given in BS 6798-1987 and BS 5449-1 1990; the following notes are given for general guidance.

### Pipework

Copper tubing to BS 2871-1 1977 is recommended for water pipes. Joining should be either with capillary soldered or compression fittings.

Where possible pipes should have a gradient to ensure air is carried naturally to air release points and water flows naturally to drain taps.

The appliance has a built-in automatic air release valve; it

should be ensured as far as possible that the appliance heat exchanger is not a natural collecting point for air. Except where providing useful heat, pipes should be insulated to prevent heat loss and avoid freezing. Particular attention should be paid to pipes passing through ventilated spaces in roofs and under floors.

### Installation of by-pass

The installation of a by-pass has no sense also if radiators has been equipped with thermostatic valves because a permanent by-pass is inside the boiler yet.

### System design

This boiler is suitable only for sealed systems.

A typical lay-out is illustrated in fig. 2.3.

### Drain cocks

These must be located in accessible positions to permit the draining of the whole system. The taps must be at least 15 mm nominal size and manufactured in accordance with BS 2870-1980.

### Air release points

These must be fitted at all high points where air naturally collects and must be sited to facilitate complete filling of the system.

The appliance has an integral sealed expansion vessel to accommodate the increase of water volume when the system is heated.

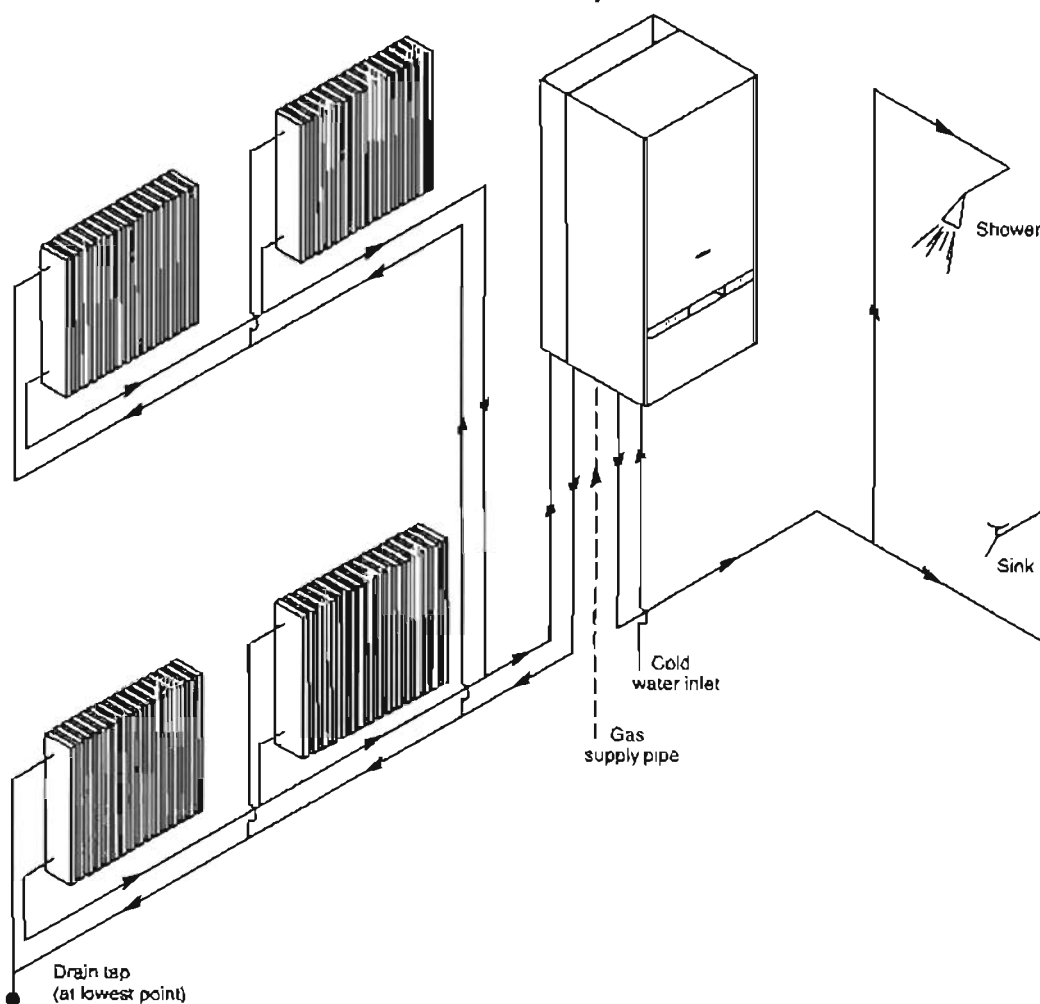

fig. 2.2

---

---

## General requirements

---

---

It can accept up to 7 lts ( 1,5 gals.) of expansion water.  
If the heating circuit has an unusually high water content, calculate the total expansion and add additional sealed expansion vessel with adequate capacity.

### Mains water feed: central heating

No direct connection to the mains water supply even through a non return valve, may be made without the approval of the Local Water Authority.

### Filling

A method for initially filling the system and replacing water lost during servicing must be provided and it must comply with local water authority regulations.

A possible method is shown in fig. 2.3.

The installer should ensure that no leaks exist as frequent filling of the sytem could cause premature scaling of the heat exchanger.

## 2.7 DOMESTIC WATER

The domestic water must be in accordance with the relevant recommendations of BS 5546. Copper tubing to BS 2871-1 is recommended for water carrying pipework and must be used for pipework carrying drinking water.

## 2.8 ELECTRICAL SUPPLY

**Warning, this appliance must be earthed.**

External wiring to the appliance must be carried out by a qualified technician and be in accordance with the current I.E.E. Regulations and applicable local regulations .

The ARISTON DIA 20 MFFICE is supplied for connection to a 230 V- 50 Hz supply.

The supply must be fused at 3 A.

The method of connection to the electricity supply must facilitate complete electrical isolation of the appliance by the use of a fused double pole isolator having a contact separation of the least 3 mm in all poles or alternatively, by means of a 3 A fused three pin plug and unswitched shuttered socket outlet both complying with BS 1363.

The point of connection to the Electricity supply must be readily accessible and adjacent to the appliance unless the appliance is installed in bathroom when this must be sited outside the bathroom.

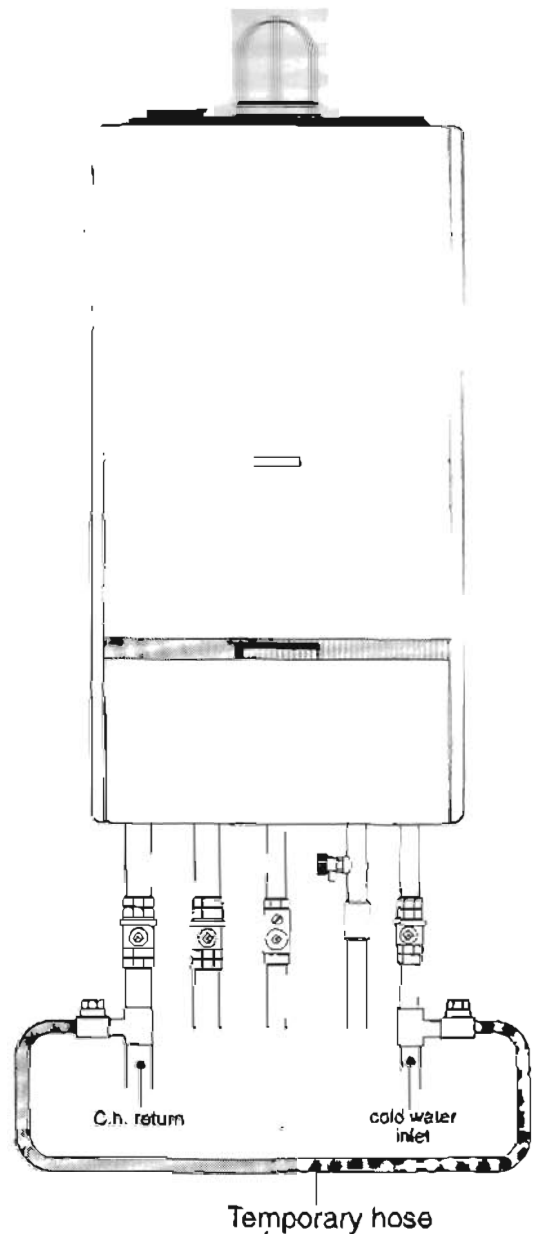

fig. 2.3

## 3 INSTALLATION

### 3.1 DELIVERY

There will be 3 items:

- 1- The fully assembled boiler;
- 2- A box containing cocks and pipes;
- 3- Standard flue assembly which include flue pipes and 90° elbow

### 3.2 MEASUREMENTS FOR INSTALLING THE APPLIANCE

#### Model DIA 20 MFICE

#### IMPORTANT!

To allow easy access to the interior of the boiler for maintenance work, keep to the minimum dimensions shown in the drawing.

fig. 3.1

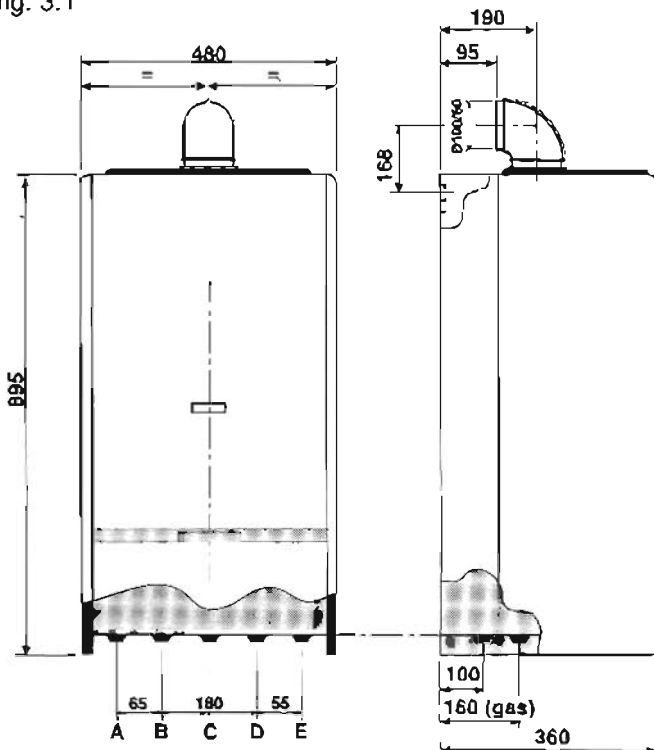

- A: C.h.w. return
- B: C.h.w. flow
- C: Gas inlet
- D: D.h.w. outlet
- E: D.w. inlet

FRONT VIEW

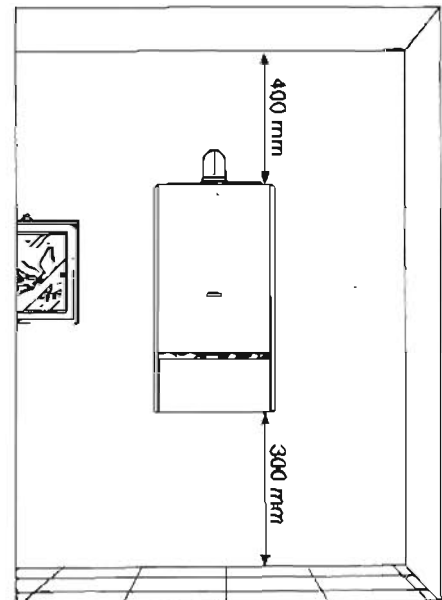

TOP VIEW

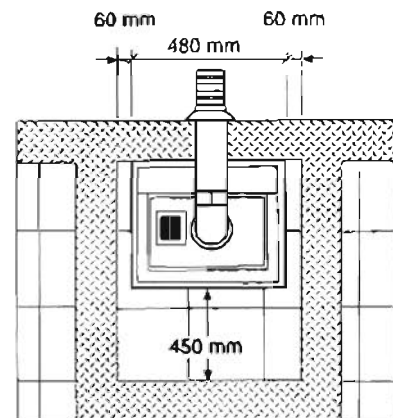

# Installation

## 3.3 UNPACKING THE BOILER

- 1- Turn the carton upside down and open;
- 2- Turn the carton right way up;
- 3- Remove the carton;
- 4- Remove valves pack, documentation and all polystyrene packing.

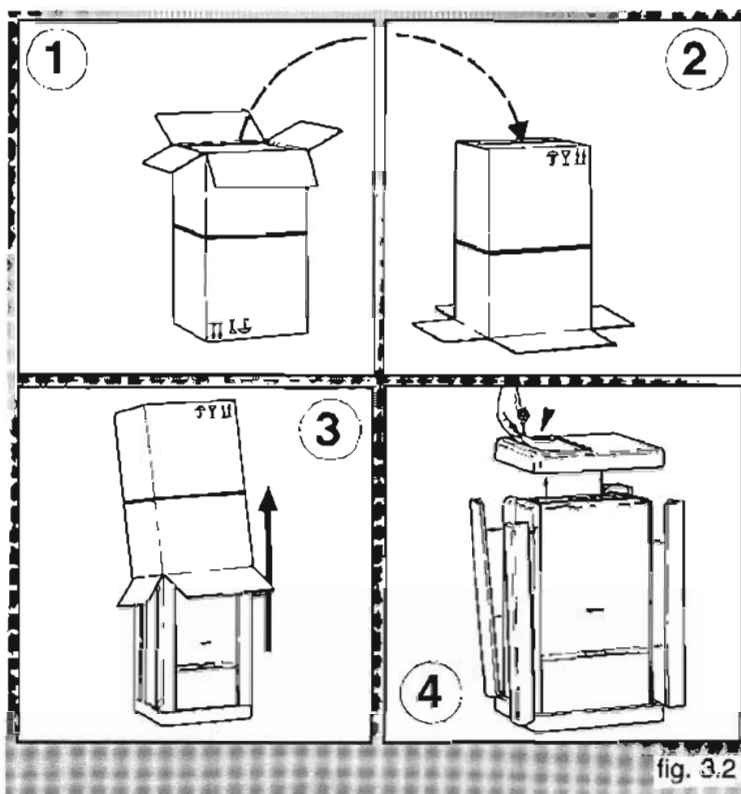

fig. 3.2

### IMPORTANT!

All of the boiler packaging ( carton and polystyrene ) is fully recyclable.



### IMPORTANT!

All packaging must be properly and thoroughly disposed of, as some components ( i.e. : polythene, staples etc. ) could prove to be dangerous to young children.

## 3.4 POSITIONING OF THE BOILER

(see fig. 3.3).

- 1- After the sitting position has been determined, allowing for clearances as shown in section 3.1, fix paper template to the wall;
- 2- Drill holes for flue "A" (A = 110 mm diam. ) and wall plate fixing "B" (B = 14 mm diam. );
- 3- Plumb service pipes to position "C";
- 4- Remove template from wall.  
Position hanging plate "D" and secure to wall via pre-drilled holes "B" ensuring that it is level.  
**important** : please ensure that the fixing method used is able to support 60 Kg.

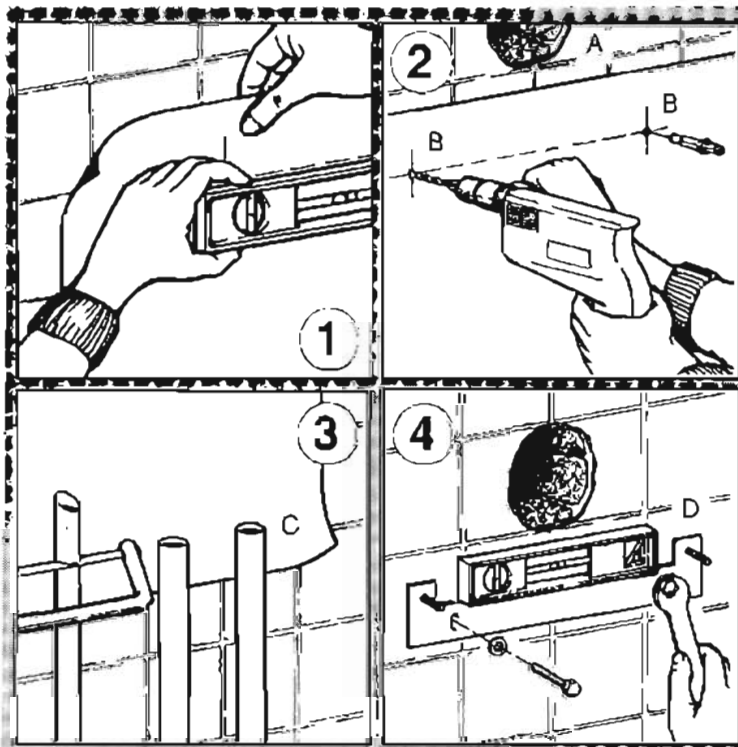

# Installation

5- Mount fitting valves connections;

6- Hang the boiler on to bolts via holes in the boiler frame "F";

7- Secure boiler with nuts "G" ensuring that washers are positioned between the nut and the boiler frame.

## NOTE:

During the drilling of hole for the flue air intake, ensure that its diameter is bigger than the pipe which will be fitted.

This, to guarantee the extraction of the pipe in case of need.

The sealant between the pipe and the wall is assured by internal and external flange (see figure below).

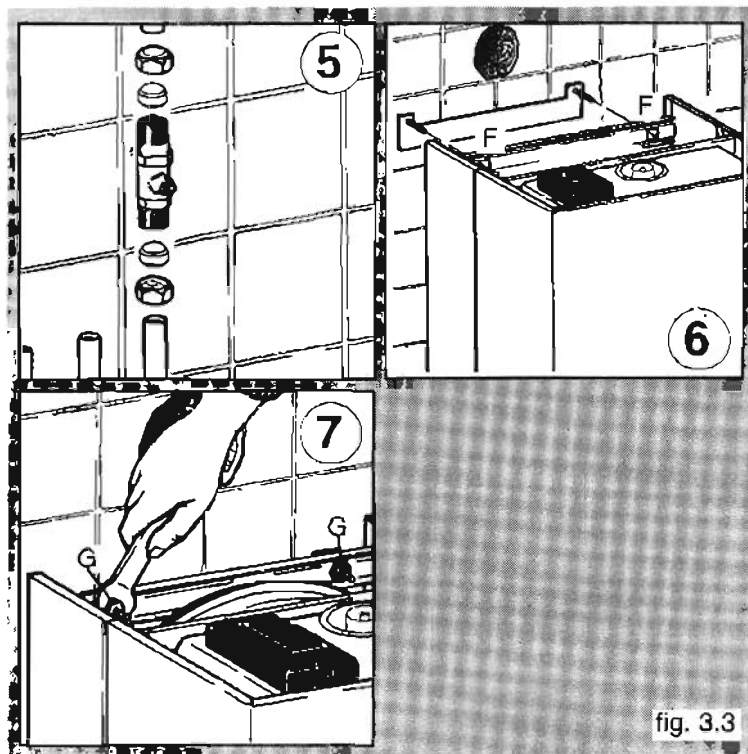

fig. 3.3

## 3.5 MOUNTING THE FLUE EXHAUST PIPES

Flue kit contains the following ( see fig. 3.4 ):

- 1- Seal gasket for 90° elbow to boiler;
- 2- 60 diam. O-Ring - coloured red;
- 3- 100/60 diam 90° elbow with internal recess for 60 diam. O-Ring;
- 4- 60 diam. O-Ring - coloured red;
- 5- Flue sealant gasket;
- 6- Tightening band for sealant gasket;
- 7- Internal flange - coloured white;
- 8- External flange - coloured grey;
- 9- Flue pipe - consisting of 100 diam. outer flue, 60 diam. inner flue spring pipe support and wind-resistant terminal;
- 10- 4,2x13 self tapping screws ;
- 11- Diaphragm for use with flue-requirements between 50 cm and 100 cm.

### Cutting the flue exhaust

If your particular installation requires you to shorten the flue, see the following instructions for cutting measures.

**N.B. :** When shortening the flue pipe, cut the external 100 diam. pipe and the internal 60 diam. pipe, keeping the original difference in length between the two ( 35 mm ). ( see fig. 3.5 ).

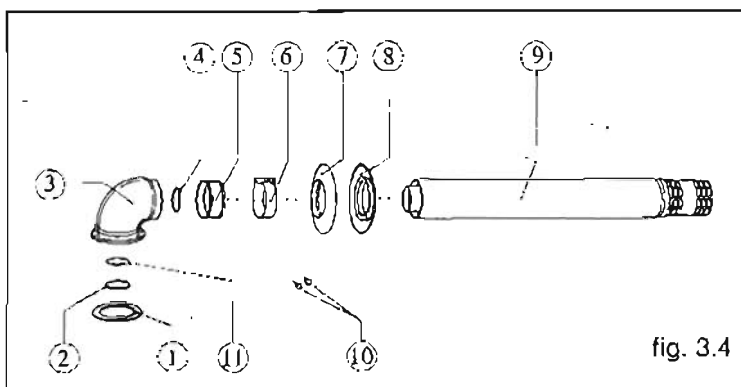

fig. 3.4

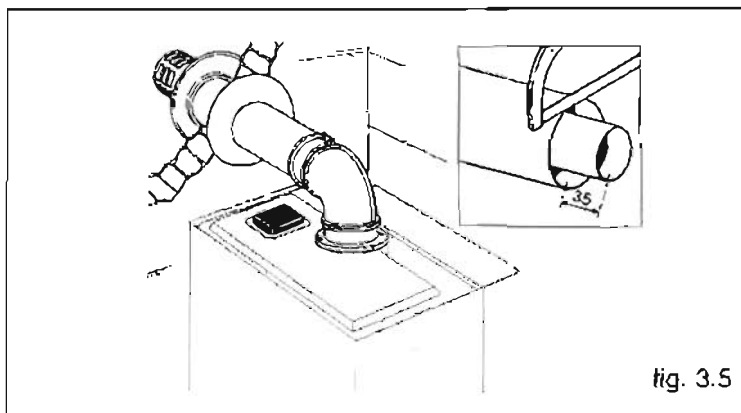

fig. 3.5

# Installation

## Maximum/minimum flue length

If you need to extend the flue or change its direction, optional kits are available.

All measures are in millimetras unless otherwise specified.

Both pipes must be cut on the side facing the elbow.

- 1 - Minimum flue length 'S' 500 mm ( see fig. 3.7 )
- 2 - Maximum flue length 'S' 3000 mm model DIA 20 MFFICE

### Note:

Where flue lengths between 50 cm and 100 cm are required, diaphragm '11' **must** be installed ( see fig.3.4 ).

For flue lengths up to 100 cm only the standard flue kit is required.

For flue lengths above 100 cm and up to 300 cm additional extension kits will be required.

max 2 kits model DIA 20 MFFICE

For flue lengths above 100 cm the diaphragm '11' **must not** be installed.

For a full list of flue pipe optional extras, please consult "flue pipe accessories I"

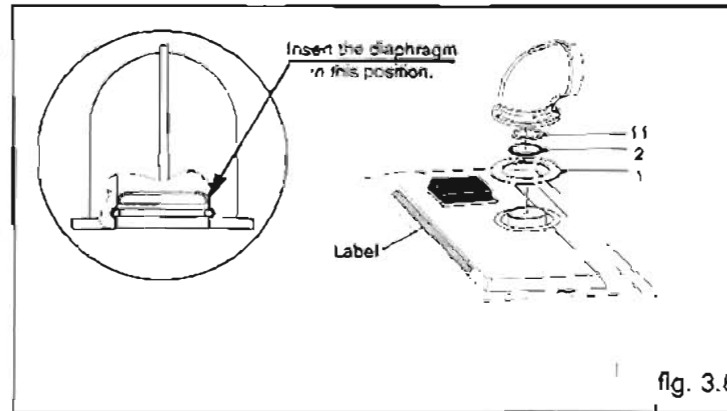

fig. 3.4

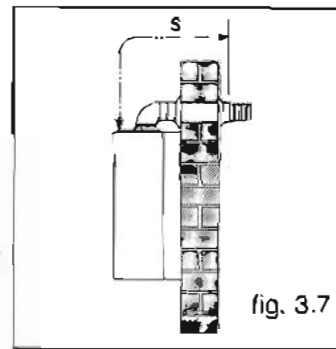

fig. 3.7

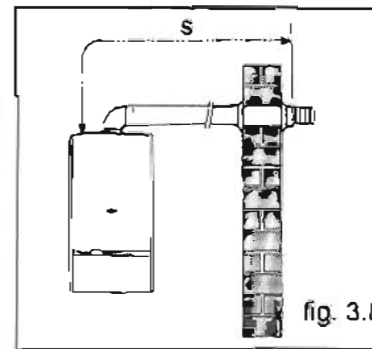

fig. 3.8

## Mounting operations (see fig.3.9)

1- Fit the 100 diam. gasket into the housing at the top of the boiler and place the two 60 diam. O-Rings in the elbow housing. Insert diaphragm if required;

2- Fix the elbow at the top of the boiler using the 4 self-tapping screws and insert the stepped sleeve;

3- Fit the external ring gasket and then insert the pipe ( from the outside ) into the hole made in the wall ;

4- Fit the internal ring gasket ;

5- Connect the flue pipe to the bend; insert the 60 diam. pipe into the elbow through to the end and the 100 diam. pipe into the sleeve;

6- Use the clamp to fix the elbow and external 100 diam. pipe together.

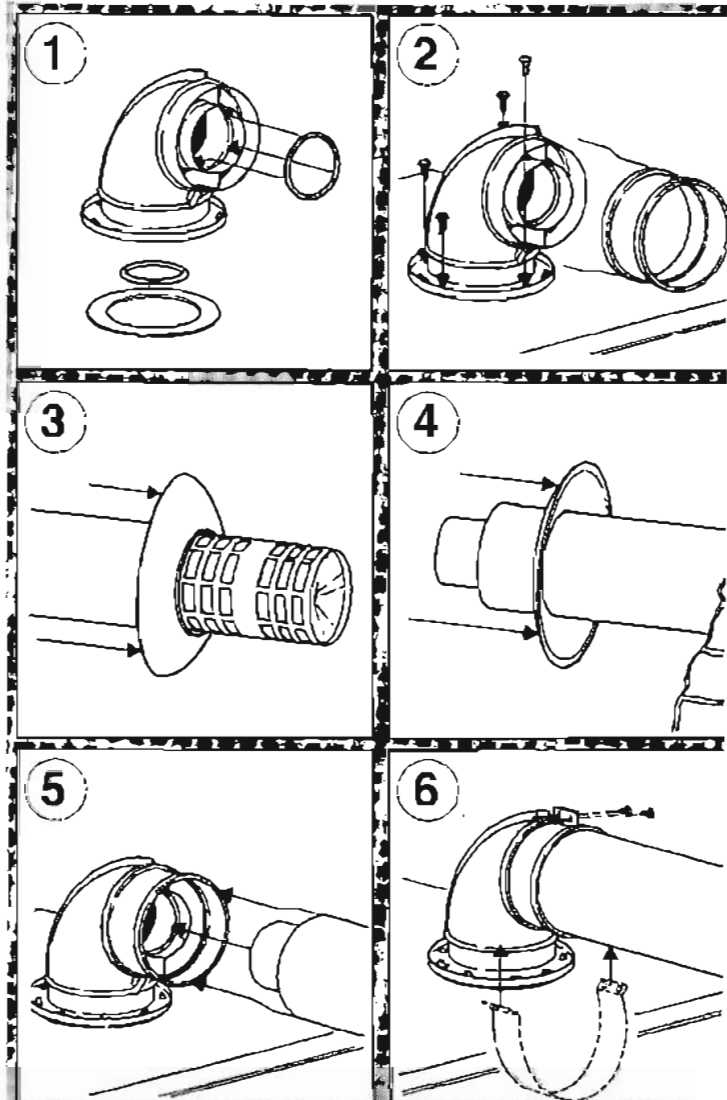

fig. 3.9

# Installation

## 3.5 FLUE TERMINAL GUARD

Where the lowest part of the terminal is less than 2 m (6.5 ft) above the level of any ground, balcony, flat roof or place to which any person has access then a suitable terminal guard must be fitted. A suitable guard is available from:

### TOWER FLUE COMPONENTS

Millorley Road  
Tonbridge  
Kent TN19 1RA

When ordering the guard, quote appliance model number.  
The guard should be fitted centrally over the terminal.

## 3.7 ELECTRICAL CONNECTIONS

### Connecting to the electricity supply

**WARNING - THIS APPLIANCE MUST BE EARTHED**

The appliance is delivered with a flexible cable for electrical supply. The cable allows the electrical connection as detailed in sect. 2.8.

### Replacing the electrical supply cable

- 1 - Ensure electricity is switched off at main isolator;
- 2 - Remove boiler casing ( see sect. 6.2 );
- 3 - Lower control panel ( see sect. 6.2 );
- 4 - Remove cables from terminals by loosening screws "A"  
( see fig.3.10 );
- 5 - Loosen screw "B" to slacken the cable holder ( see fig.3.11 );
- 6 - Remove the cable;
- 7 - Insert the new cable through grommet.  
A PVC insulated flexible cable must be used. it must be a three core of size 0.75 mm<sup>2</sup> ( 24x0.2 mm ) to BS6500 table 16;
- 8 - Connect the cable to the terminals marked as follows:
  - L Brown or red wire ( live )
  - N Blue or black wire ( neutral )
  - ⊕ Green/yellow or green wire ( earth );



fig. 3.10

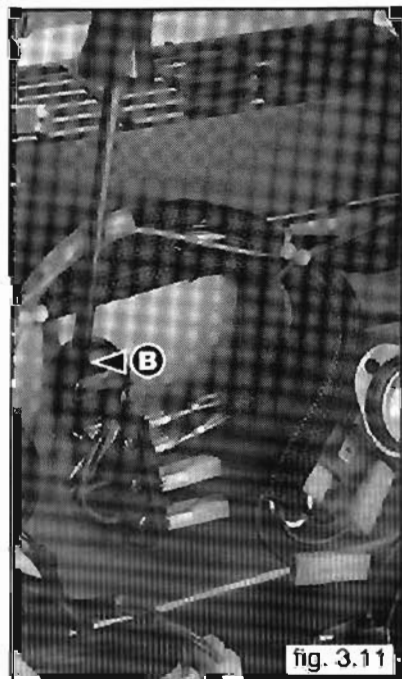

fig. 3.11



## Installation

### Electrical connection of a room thermostat (see fig.3.12)

Remove the green connector within two U-links, placed on the left of the P.C.B.

Remove one of the two brown U-links.

It does not matter which one of the two links is removed.

Fit the wires of the room thermostat.

Fit the connector in its housing.

### NOTE:

The other brown U-link which remains in the connector is used to fit a time clock (if not already fitted).

### IMPORTANT!

The room thermostat and/or the time clock must be of a low voltage type (i.e. no live connection).

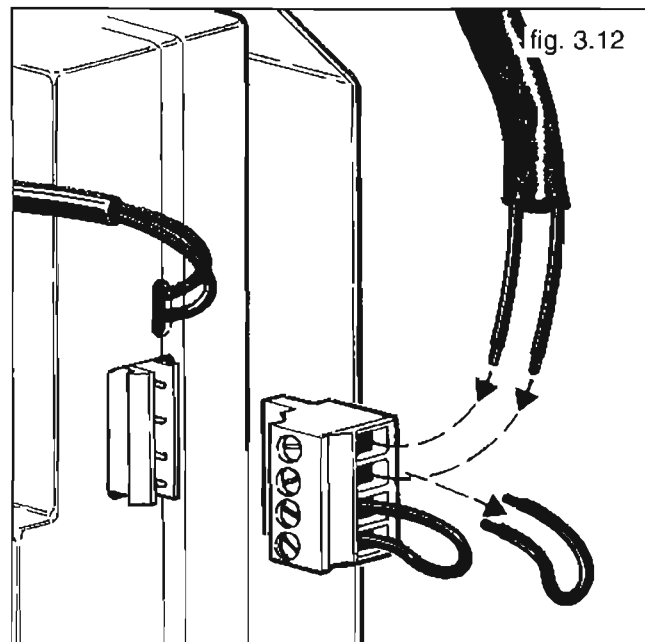

# COMMISSIONING

## 4.1 ELECTRICAL INSTALLATION

Preliminary electrical system checks to ensure electrical safety must be carried out by a qualified electrician.

- polarity, earth continuity, resistance to earth and short circuit.
- if a fault has occurred on the appliance the fault finding procedure should be followed as specified under the servicing section of this document.

## 4.2 GAS SUPPLY INSTALLATION

- Inspect the entire installation including the gas meter, test for soundness and purge, as described in BS6891;
- Open the gas cock ( drawn with the knob in "open" position on the appliance ) and check the gas connector on the appliance for leaks (see fig. 4.1).

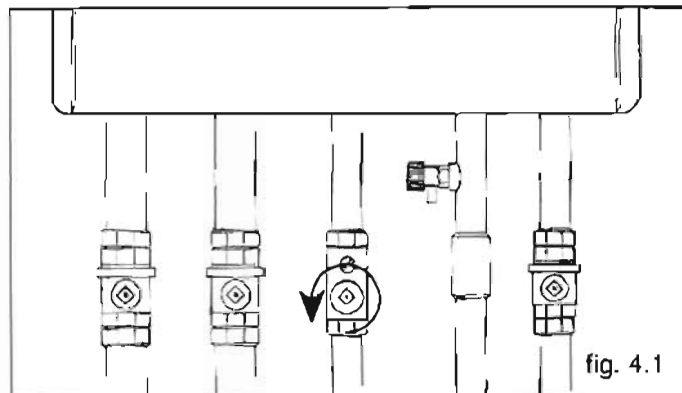

## 4.3 FILLING THE D.H.W. SYSTEM

- Close all hot water draw-off taps;
- Open the cold water inlet cock as indicated in fig. 4.2;
- Slowly open each draw-off tap and close it only when clear water, free of bubbles, is visible.

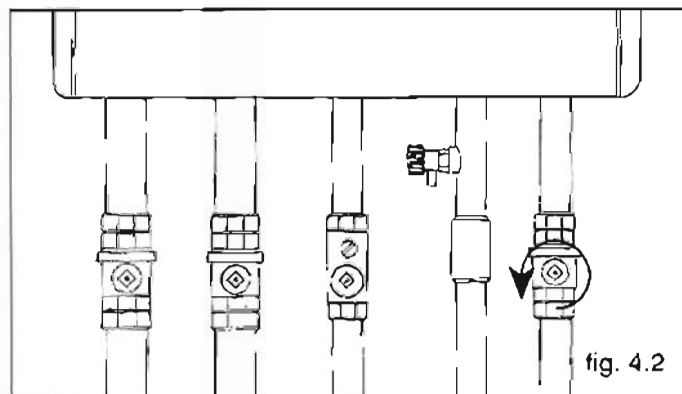

## 4.4 INITIAL FILLING OF THE SYSTEM

- 1 Open central heating flow and return cocks as indicated in fig. 4.3;
- 2 Unscrew the cap on the automatic air release valve one full turn and leave open permanently;
- 3 Close all air release valves on central heating system;
- 4 Gradually open stopcock at the filling point connection to central heating system until water is heard to flow; do not open fully;
- 5 Open each air release tap starting with the lower point and close it only when clear water, free of bubbles, is visible;
- 6 Remove the front panel of the case and lower the control panel ( sect. 5.2 );
- 7 Purge the air from the pump by unscrewing the pump plug indicated as indicated in fig. 4.4; release the pump by turning the rotor in the direction indicated by the arrow on the information plate;
- 8 Close the pump plug;
- 9 Continue filling the system until at least 1 bar ( 14.5 p.s.i. ) registers on the temperature-pressure gauge;
- 10 Inspect the system for water soundness and remedy any leaks discovered.

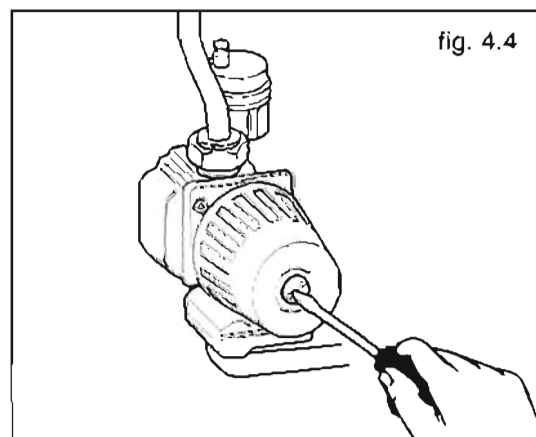
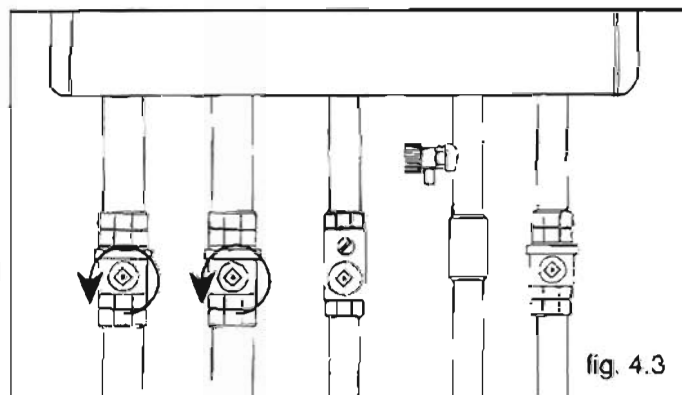

# Commissioning

When the installation and filling are completed turn on the central heating system ( sect. 4.5 ) and run it until the temperature has reached the boiler operating temperature. The system must then be immediately flushed through. The flushing procedure must be in line with BS7593:1992 *treatment of Water in Domestic Hot Water Central Heating Systems*.

During this operation, we highly recommend the use of a central heating flushing detergent, whose function is to dissolve any foreign matter which may be in the system i.e. Fernox Superfloc or equivalent.

**Substances different from these, could create serious problems to the pump or others components.**

We also recommend the use of an inhibitor in the system such as Fernox MB1 Universal or equivalent

## 4.5 SETTING THE SYSTEM PRESSURE

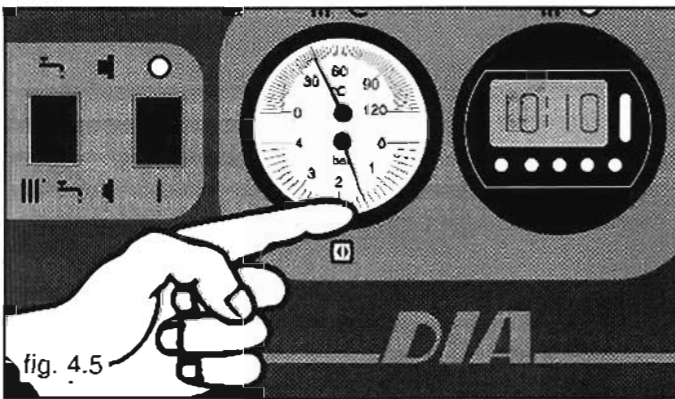

The actual reading should ideally be 1.5 bar (see fig. 4.5).

## 4.6 LIGHTING THE BOILER

Set the time clock to manual ( I ) - if fitted. If external controls are fitted e.g. Timeclock, room thermostat ensure that they " call for heat ".

1 Switch on the electricity and turn on boiler by pushing button "A", ensuring that the neon is on. ( If neon does not come on then check electrical connections ) (see fig. 4.6).

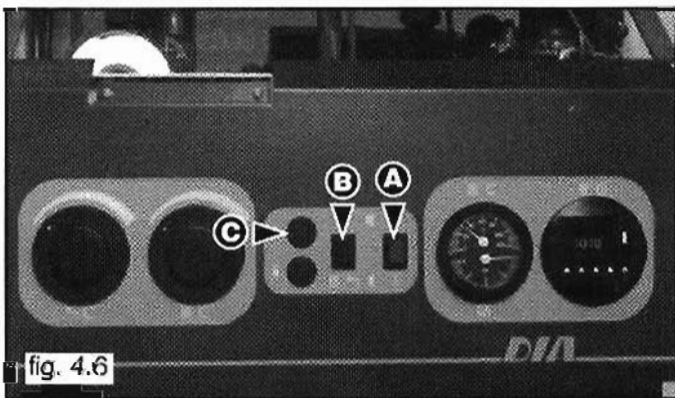

2 Select heating mode by setting button "B" to heating mode III (see fig. 4.6).

3 Check the burner pressures and adjust as necessary as in section 6.5.

The boiler will now go through an ignition sequence and the burner will light.

## 4.7 CHECKING THE FULL SEQUENCE CONTROL

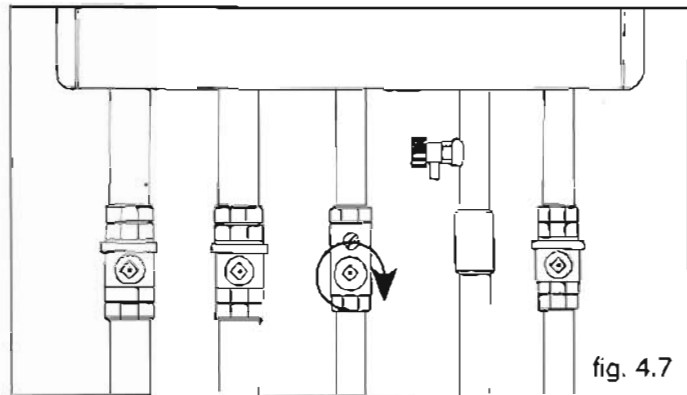

With the burner on high flame, close the gas cock ( drawn with the knob in "close" position ) turning the screw in a clockwise direction (see fig. 4.7);

After several seconds, the shut-down warning light will appear.

To reset the boiler, open gas cock and depress the reset push button "C" marked with the symbol ⚡ (see fig. 4.6).

## 4.8 TESTING THE D.H.W. SYSTEM FLOW

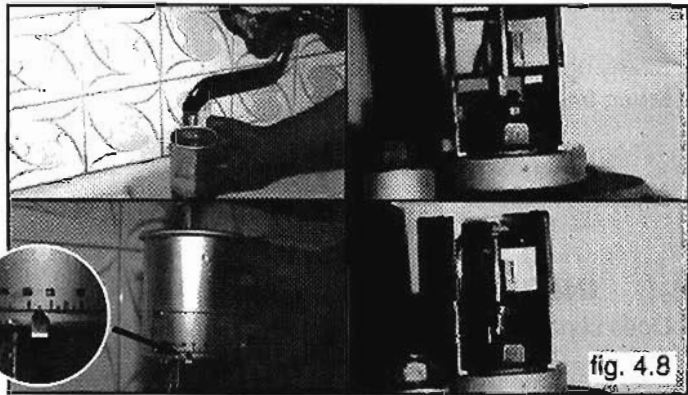

1 Turn the function switch as indicated and check the switching flow rate that should be at minimum 2.5 lts/min ( 0.66 gals/min );(see fig. 4.8)

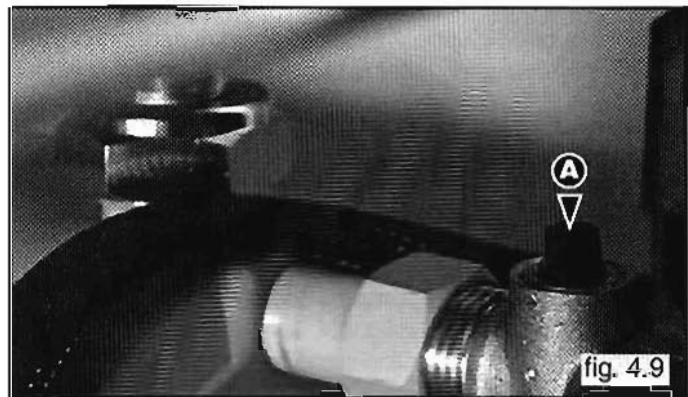

2 To set maximum flow

- Turn on the tap with maximum water flow fully ( e.g. bathtub );
- Using a flow meter, set the flow on 13 lts/min ( 3.43 gals/min ) by turning screw "A" (see fig. 4.9).

## 5 MAINTENANCE

### 5.1 GENERAL

To ensure efficient, safe operation of the appliance it is necessary to carry out routine maintenance at regular intervals.

The frequency of servicing will depend upon the particular installation conditions and the use of the boiler, but, in general, once a year should be adequate.

The following notes apply to the appliance but it should be remembered that attention must be also paid to the central heating and domestic hot water circuits with special attention to radiator valves; thermostats, clocks, leaking hot water taps etc.

#### WARNING

Before starting any servicing work, switch-off the electrical supply or disconnect the plug at the main isolating switch and socket ( if a switch is used remove the fuse ).

After any service on electrical components carry out a preliminary electrical checks; in particular:  
earth continuity;  
polarity;  
earthing resistance;  
short circuit.

### 5.2 RECOMMENDED ROUTINE MAINTENANCE

The following procedures should be carried out at least once a year:

- 1 Verify that the electrical connections, the flue pipework and the case are in good condition;
- 2 Inspect ventilation arrangements as explained in section 2.6 to ensure no alterations have been made since installation;
- 3 Switch-off the electrical supply and remove the front panel of the case ( section 6.2 );
- 4 Switch-on the electrical supply and run the boiler for few minutes in d.h.w. mode;
- 5 Check that the flame covers all the flame ports and is of a light blue colour. Yellow flames and excessive lifting of flames indicate poor combustion.
- 6 Visually check the flue system for soundness. Check all clamps, gaskets and fixings are secure and tight. To check the exhaust gas, remove the right screw indicated in fig. 5.1 and connect the analyser to the flue gas sampling point. To check the air inlet temperature, remove the left screw indicated in fig 5.1 and insert the probe of a thermometer.

To inspect and clean the appliance

- 7 Switch-off the electrical supply, remove the sealed chamber cover and open the combustion chamber ( section 6.2 );
- 8 If during initial check any combustion irregularity is suspected, remove the burner and the injectors ( section 6.13 ).  
Clean or replace if necessary;
- 9 Inspect the main heat exchanger for any deposits of soot. If cleaning is necessary place a cloth over the burner to catch debris and clean the main heat exchanger using a soft brush.  
Do not use brushes with metallic bristles;
- 10 Inspect the combustion chamber panels.  
Damaged panels should be replaced;
- 11 Examine the fan for any mechanical damage and check to ensure free running of the fan motor;
- 12 Check sealing gaskets and replace if required;
- 13 Replace all parts in reverse order with the exception of the case and the control panel;
- 14 Undertake a complete commissioning check as detailed in section 4;
- 15 Close-up the control panel and the case;
- 16 Clean the case using a soft cloth.

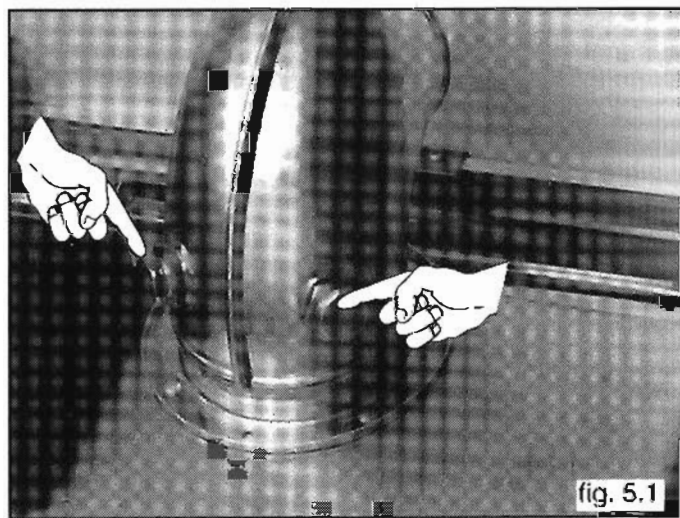

fig. 5.1

# **SERVICING INSTRUCTIONS**

## **REPLACEMENT OF PARTS**

The life of individual components varies and they will need servicing as and when faults develop.

The fault finding sequence chart in chapter 7 will serve to locate which component is the cause of any malfunction, and instructions for removal, inspection and replacement of the individual parts are given in the following pages.

## **TO GAIN GENERAL ACCESS**

All testing and maintenance operations on the boiler require the control panel to be lowered. These operations also require the removal of the casing.

The casing is fixed to the boiler frame by 4 screws (see fig. 6.1):

- 1- Remove 2 screws located at the bottom of the appliance. To do this we suggest that the case door is open and a long pozi-drive n°2 screw driver is used;
- 2- Remove 2 screws located on the front of the boiler, under the case door.  
Use the same screw driver as above;
- 3- Remove the case by pulling upwards and forwards;
- 4- Remove 2 screws at the top of control panel using the same screw driver as above.  
Support the panel whilst lowering.

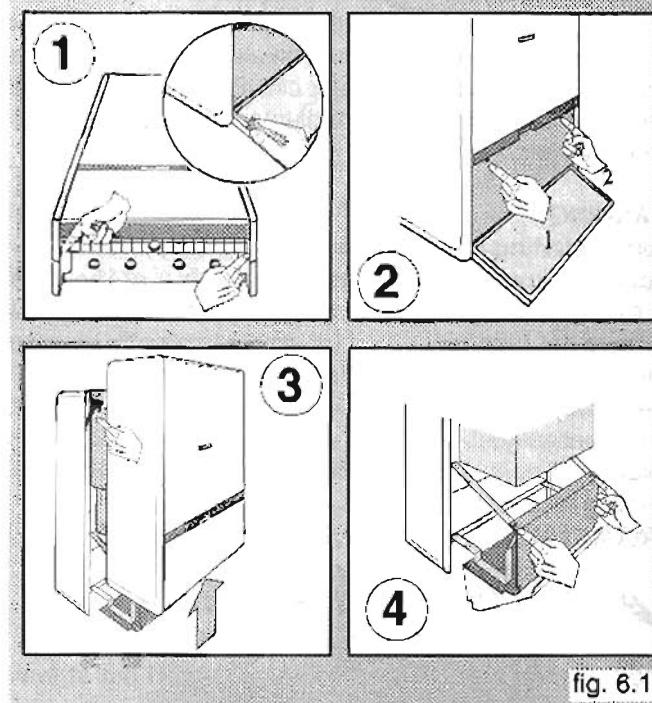

### **Removing the sealed chamber cover**

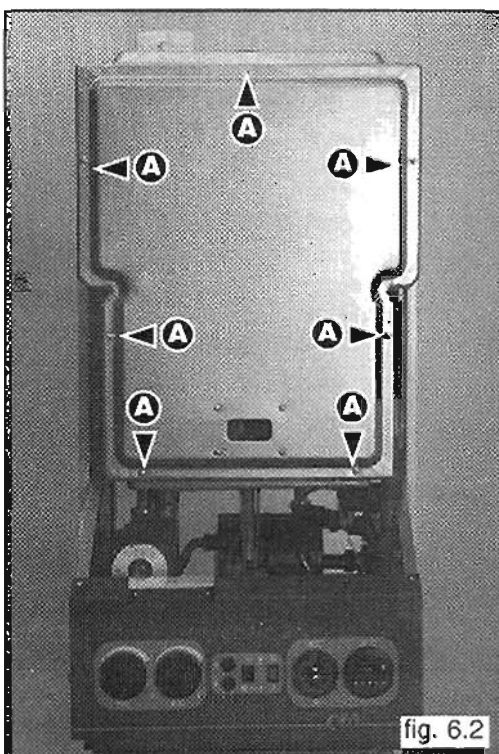

To remove the cover, remove screw A (see fig. 6.2). Pull cover forward. When replacing cover ensure that the silicone seal is in good condition. If not replace the seal.

### **Opening combustion chamber**

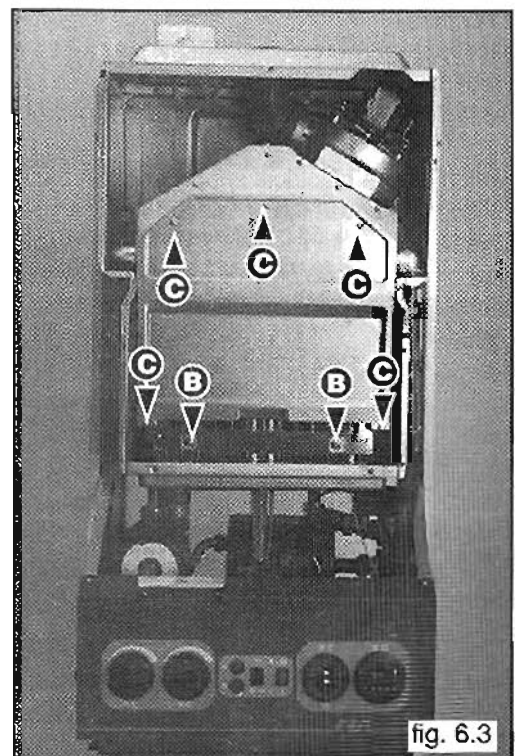

- 1 Remove screw B;
- 2 Remove screw C;
- 3 Pull forward and remove.

# Servicing instructions

## 3.3 TO DRAIN THE MAIN CIRCUIT OF THE BOILER

- 1 Close c.h. flow and return cocks;
- 2 Release the manual vent cock (see fig.6.4);
- 3 Attach a small hose to the drainage cock "A" (see fig.6.5);
- 4 Open cock "A" and drain water from boiler.

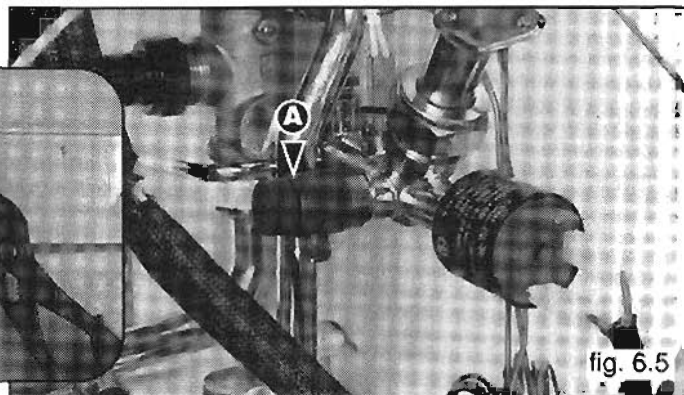
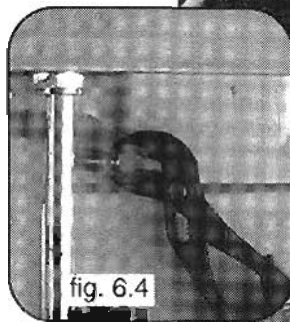

## 3.4 TO DRAIN THE D.H.W. CIRCUIT OF THE BOILER

- 1 Close the cold water inlet cock;
- 2 Open the d.h.w. circuit drainage.

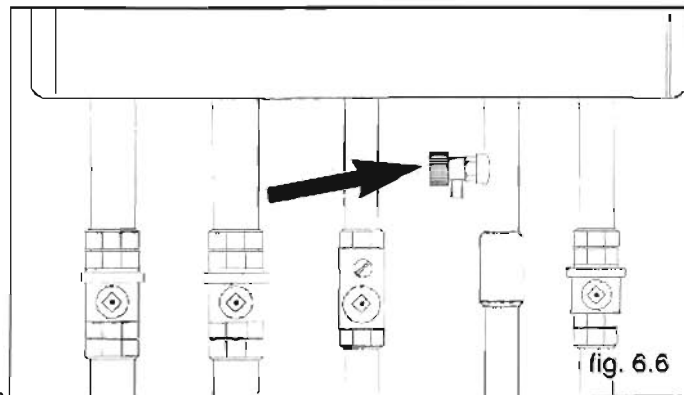

## 3.5 SETTING GAS PRESSURES

Setting the minimum and the maximum power of the boiler (see fig.6.8)

- 1) Check the special link (inside the P.C.B.) is correctly fitted in relation to the gas that is using ( see fig.1 ).
- 2) Check that the supply pressure of gas valve is 20 mbar for natural gas.
- 3) To do this, remove the screw "B". Fit the pipe of the pressure gauge to the pressure connection of the gas valve. When you have completed this operation, fit the screw "B" securely into its housing to seal off the gas.
- 4) To check the pressure supplied by the gas valve, remove the screw "A". Fit the pipe of the pressure gauge to the pressure outlet of the gas valve. Disconnect the compensation pipe either from the gas valve or from the sealed chamber (see fig.6.7 a-b)

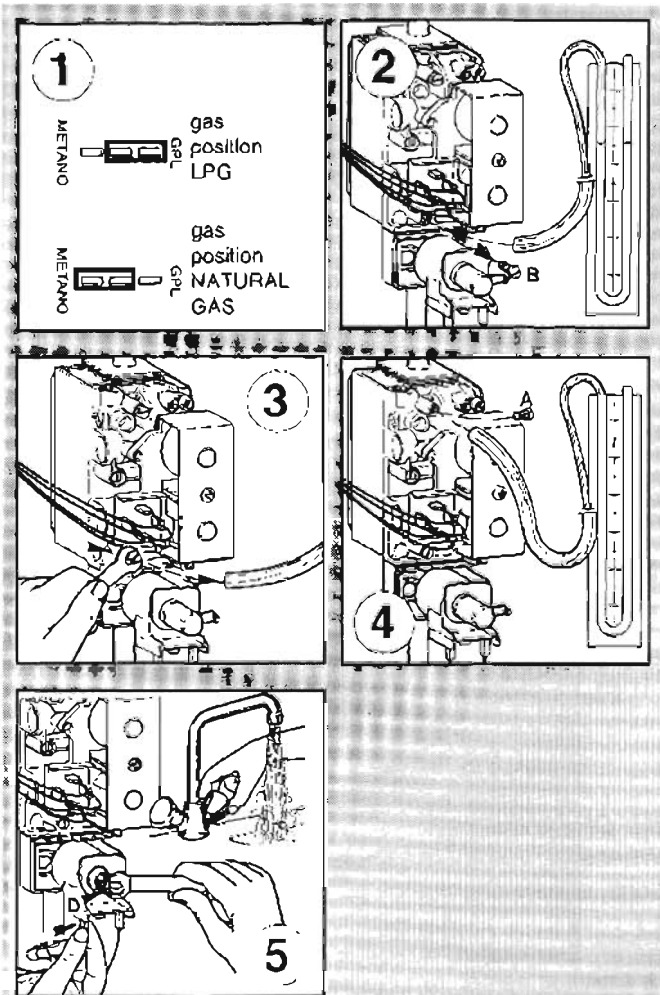
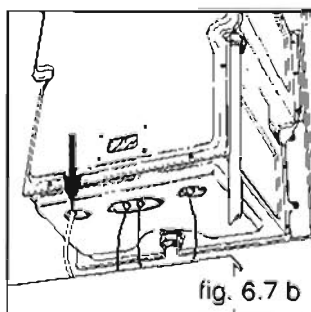
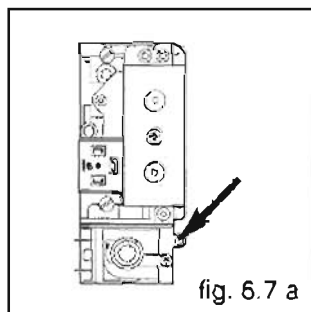

- 5) Set the ON/OFF switch to position <I> and the "summer/winter" switch to winter position III' ↖. To set the maximum power, turn on the hot water tap and allow hot water tap to run at a rate of about 8 litres/minute so that the main burner lights. Adjust screw "D" on the solenoid to set the pressure valve ( displayed on the pressure gauge ) corresponding to the maximum power ( see table sect.1.1...2 ).



## Servicing instructions

- 7) To set the minimum power, disconnect a supply terminal and adjust screw "C".  
Turn the screw clockwise to increase the pressure and counter-clockwise to decrease the pressure ( displayed on the pressure gauge ) corresponding to the minimum power ( see table sect.1.2 ).
- 8) When you have completed the above operations, turn off the hot water tap, re-connect the supply terminal to the solenoid on the gas valve and replace the cap on the screw of the solenoid.

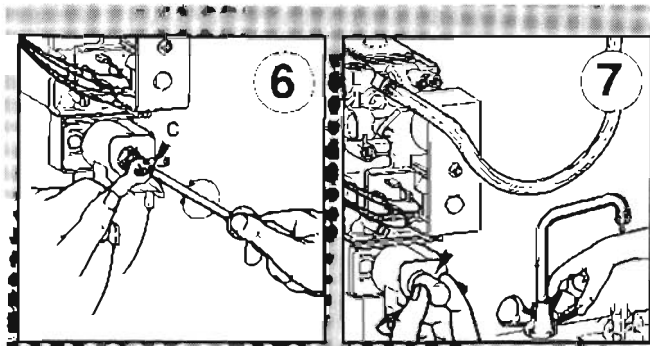

fig. 6.8

### Setting the maximum heating circuit power (see fig. 6.9)

- 1) To set the maximum heating circuit power, place the ON/OFF switch to position <I> and the "summer/winter" switch to winter position III ↗.  
Turn the knob of the heating thermostat clockwise to maximum;
- 2) Lower control panel and find PCB on its internal left side. Remove the transparent cover and fit a cross-head screw driver in to the left side potentiometer. Turn clockwise to increase the pressure or counter-clockwise to reduce the pressure. Adjust the setting to the required heating pressure value ( displayed on the pressure gauge ), as indicated in the diagrams shown at the end of this manual.
- 3) Turn off the boiler by placing the main switch on "OFF" position. Disconnect the detection electrode cable. Turn on the boiler by placing the main switch to position "I" and sparks will come on. Check the gas pressure on the pressure gauge which must be about 5 mbar .

	NATURAL GAS G20
Recommended pressure for slow ignition	5 mbar

If it is necessary adjust the slow ignition.  
Fit a cross-head screw driver into the hole marked "REGULATION OF SLOW BURNER IGNITION" on the electronic P.C.B., through the potentiometer.

- 4) Remove the pipe of the pressure gauge and connect screw "A" to the pressure outlet in order to seal off the gas.
- 5) Carefully check the pressure outlets for gas leaks ( valve inlet and outlet ).

### IMPORTANT!

Whenever you disassemble and reassemble the gas connections, always check for leaks using a soap and water solution.

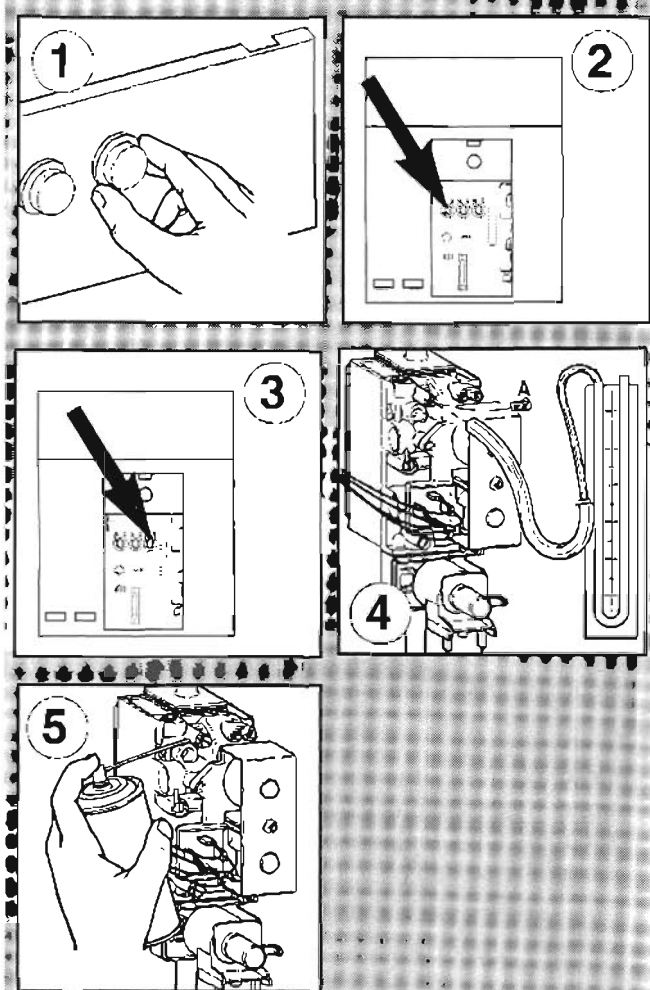

fig. 6.9

### Setting the delay of the ignition of the heating control

This appliance is equipped with a potentiometer which delays the ignition of the heating control and is situated on the P.C.B. (see the electric diagrams).

By adjusting the potentiometer, it is possible to change the time interval between the burner shutting down and its next ignition.

It is preset at 1 minute and can be adjusted from 0 to 2 minutes.

We could need this control in particular situations with continuous shutting down and ignitions of the main burner.

# Servicing instructions

## 3.5 OVERHEAT THERMOSTAT

1 Ensure electricity is switched off at main isolator;

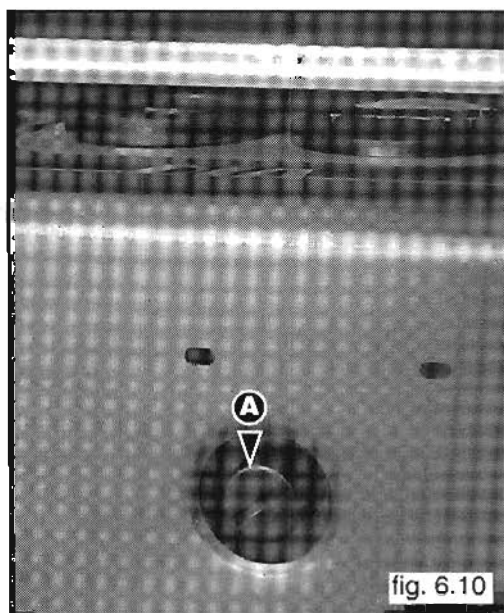

2 Remove cap "A" ( see fig. 6.10 );

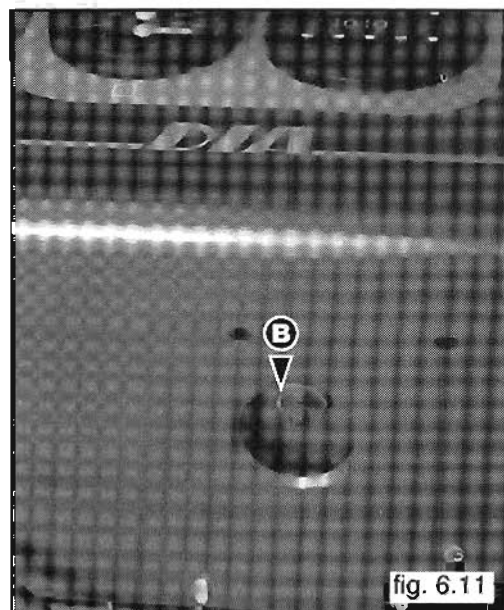

3 Remove the securing nut "B" ( see fig. 6.11 );

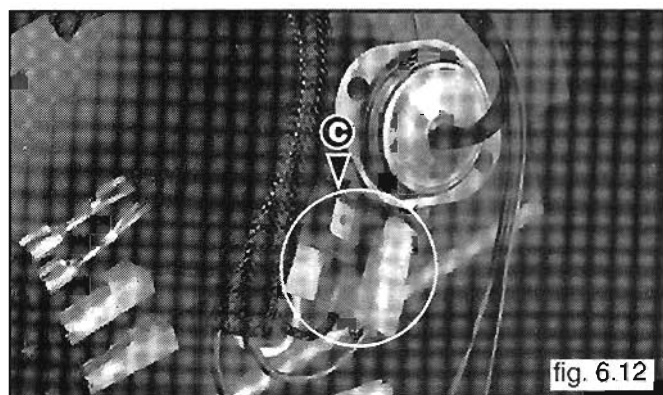

4 Lower control panel ( sect. 6.2 ) and remove electrical connectors "C" ( see fig. 6.12 );

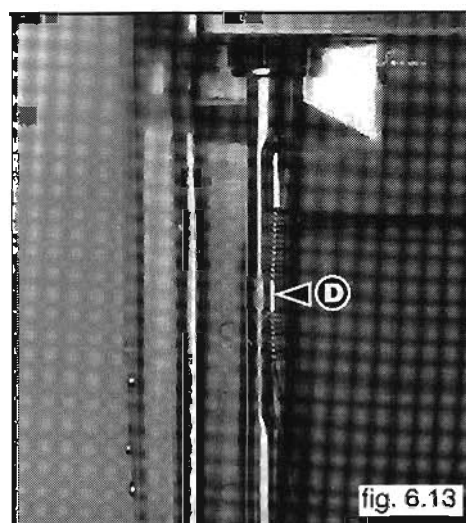

5 Remove spring "D" ( see fig. 6.13 ).

6 Reassemble in reverse order.

## 3.7 REMOVING IGNITION ELECTRODES

1 Ensure electricity is switched off at main isolator;

2 Lower control panel ( sect. 6.2 );

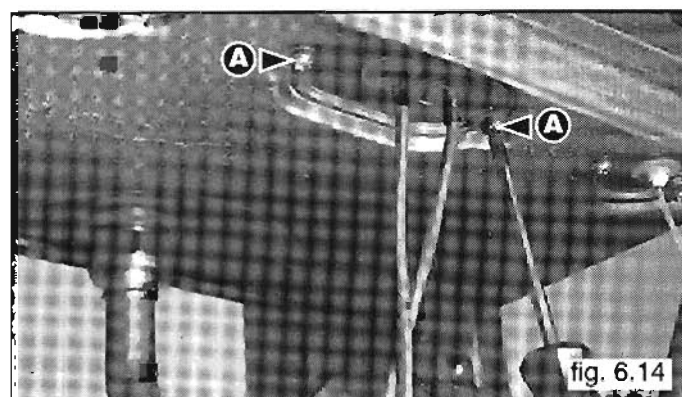

3 Remove screw "A" using a POZI-DRIVE No.2 star tip screw-driver ( see fig. 6.14 );

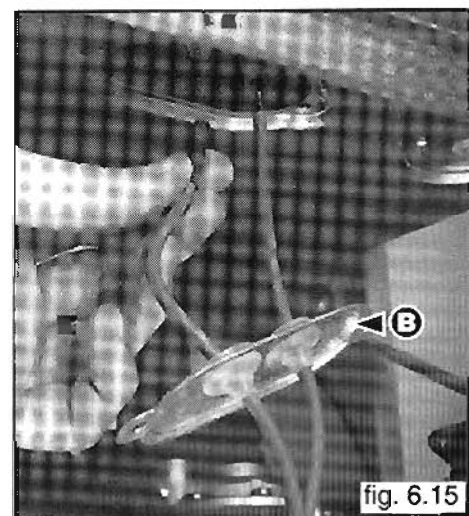

4 Slide the plate "B" and disconnect the cables pulling them downwards ( see fig. 6.15 );



## Servicing instructions

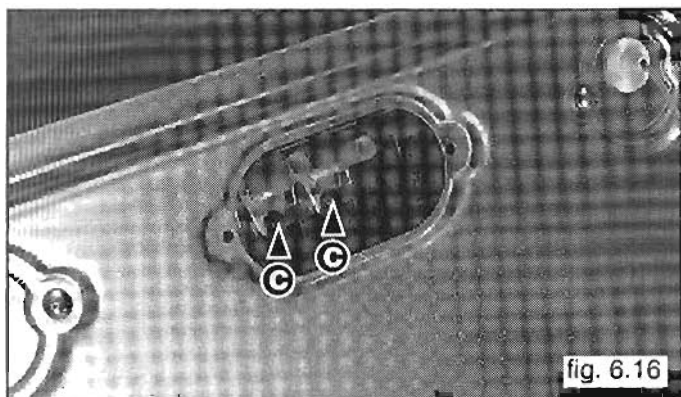

5 Remove screw "C" using a PHILLIPS No.2 star tip screw-driver ( see fig. 6.16 );



6 Slide the electrodes gently downwards ( see fig. 6.17 );

To mount, repeat the steps in reverse order, paying particular attention to the following:

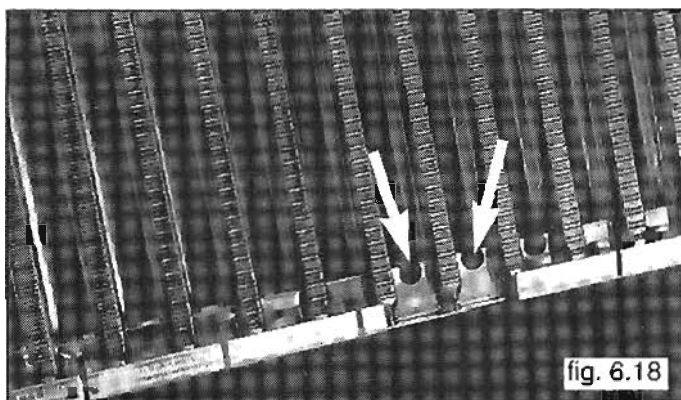

a Centre the second support hole which you will find between the connections, otherwise the electrode may break ( see fig. 6.18 );

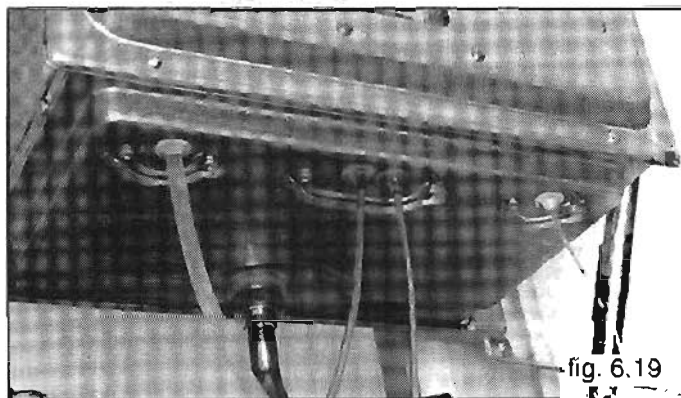

b Check that the cables have in fact been connected, since friction and interference are often misleading ( see fig. 6.19 );

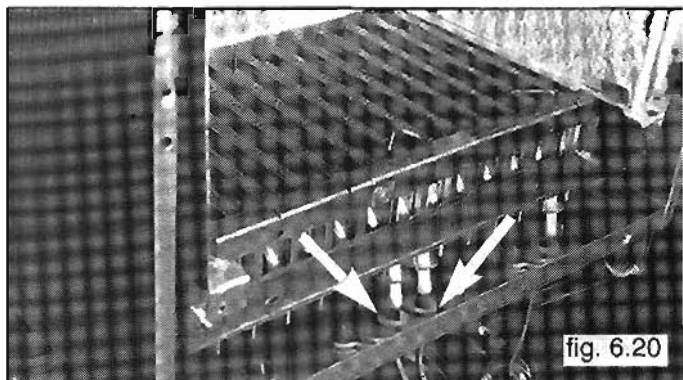

c Check that the transparent silicone pipe covers the cable-electrode connection point adequately ( see fig. 6.20);

### 6.8 REMOVING FLAME SENSOR

- 1 Ensure electricity is switched off at main isolator;
- 2 Lower control panel ( sect. 6.2 );

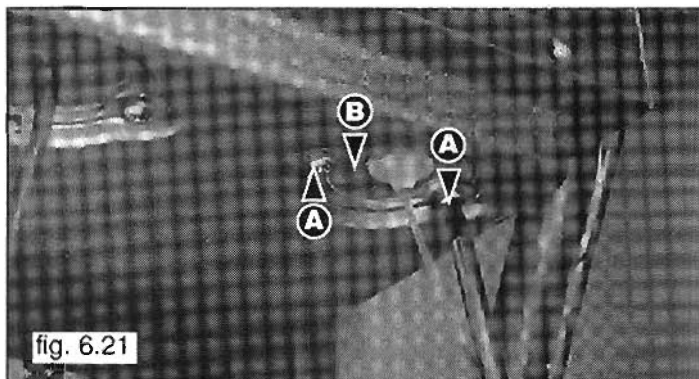

3 Remove screw "A" using a POZI-DRIVE No.2 star tip screw-driver( see fig. 6.21 );

4 Slide plate "B" downwards ( see fig. 6.21 );

5 Remove the screw using a PHILLIPS No.2 star tip screw-driver;

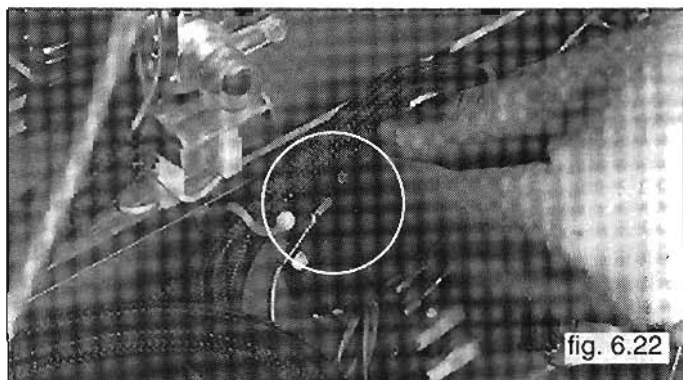

6 Slide the electrode downwards very gently;

7 Disconnect the cable at its only connection point close to the p.c.b. ( see fig. 6.22 );

When you reassemble the part, follow the steps in reverse

## Servicing instructions

order ensuring that you centre the second support hole between the connection, otherwise the electrode may break.

### REMOVING D.H.W. AND C.H.W. POTENTIOMETERS

Both potentiometers are mentioned because they are connected together.

It is not possible to remove only one potentiometer!!

1 Ensure electricity is switched off at main isolator;

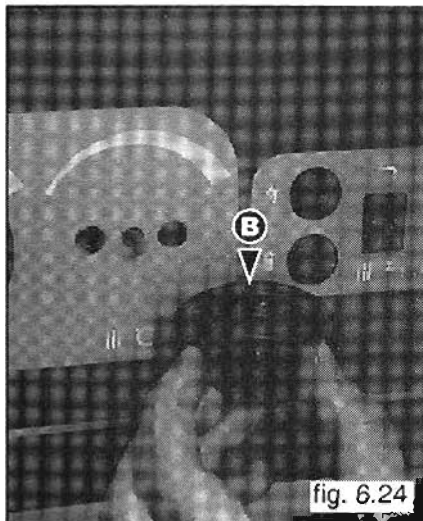
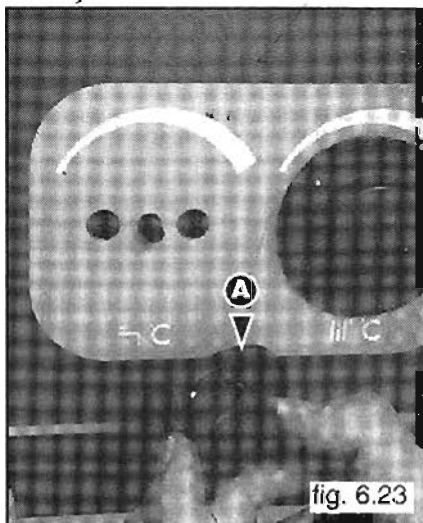

2 Remove knobs "A" (see fig. 6.23) and "B" (see fig. 6.24);

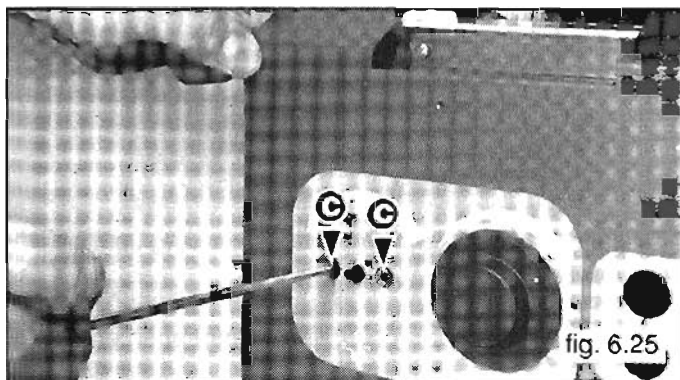

3 Remove screws "C" using a Phillips n°2 star tip screw driver (only two visible). (see fig. 6.25);

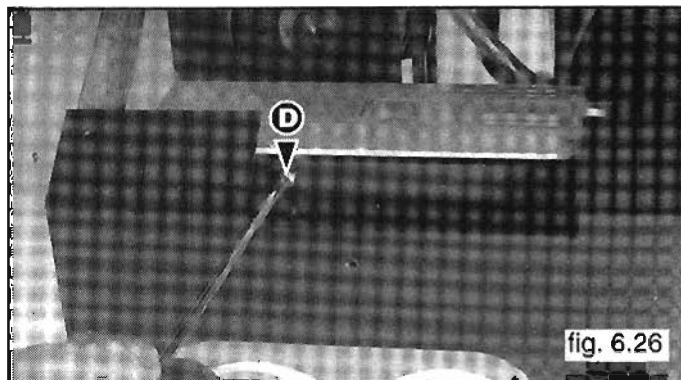

4 Remove screws "D" using a Pozi-drive n°2 star trip screw driver (one is visible). (see fig. 6.26);

5 Lower control panel;



6 Disconnect special cables for ignition electrodes (see fig. 6.27);

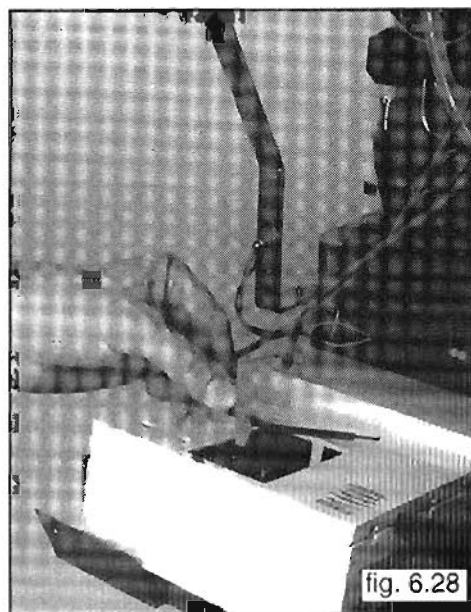

7 Remove the small transparent cover by pushing on the front side (see fig. 6.28);

## Servicing instructions

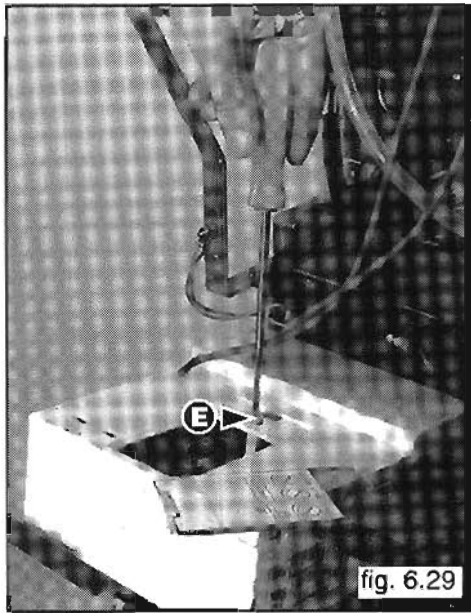

8 Open the P.C.B. box removing the not visible screw "E". This end use a Phillips n°2 star trip screw driver (see fig. 6.29);

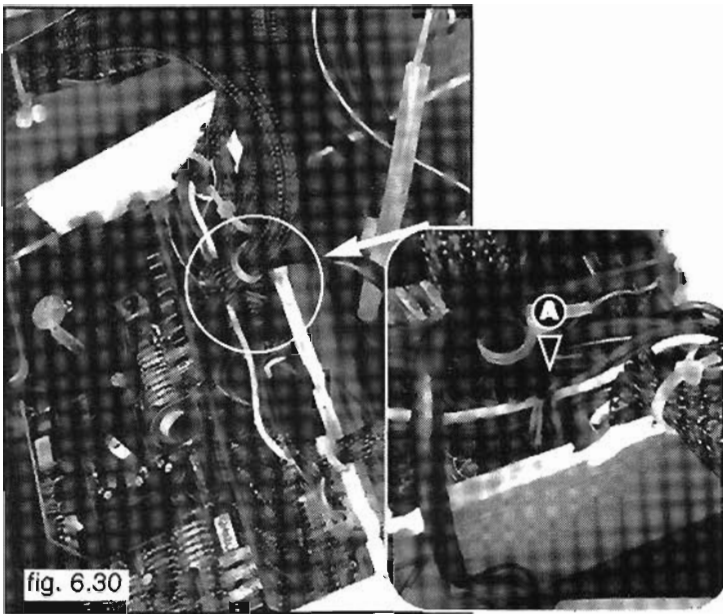

9 Remove connector "K" (see fig. 6.30);

10 Remove both potentiometers lifting the P.C.B box slowly at the front side;

11 Reassemble in reverse order.

### 6.10 REMOVING D.H.W. SENSOR PROBE

1 Ensure electricity is switched of at main isolator.

2 Lower control panel (sect. 6.2);

3 Drain DhW circuit (sect. 6.4);



4 Disconnect the electric connector by pulling back (see fig. 6.31);

5 Unscrew the sensor probe using 14 mm open ended;

6 Reassemble in reverse order.

### 6.11 REMOVING C.H.W. SENSOR PROBE

1 Ensure electricity is switched of at main isolator.

2 Lower control panel ( sect. 6.2 );

3 Drain boiler ( sect. 6.3 );



4 Disconnect the electric connector by pulling up (see fig. 6.32);

5 Unscrew the sensor probe using 14 mm open ended;

6 Reassemble in reverse order.



## Servicing instructions

### 5.12 MICROSWITCHES ON DIVERTOR VALVE

- 1 Ensure electricity is switched off at main isolator;
- 2 Lower control panel ( sect. 5.2 );



- 3 Remove retention clip A ( see fig. 6.33 );
- 4 Lift box B and remove from valve ( see fig. 6.33 );



- 5 Remove cover C if fitted ( see fig. 6.34 );
- 6 When disconnecting electrical connection, mark in reference points to help you reassemble the part without problems;
- 7 Reassemble in reverse order.

### 5.13 BURNER and INJECTORS

- 1 Ensure electricity is switched off at main isolator;
- 2 Lower control panel ( sect. 5.2 );
- 3 Remove all electrodes ( sect. 5.7 and 5.8 );



- 4 Remove the 4 screws "A" using a PHILLIPS No.2 star tip screw-driver ( see fig. 6.35 );

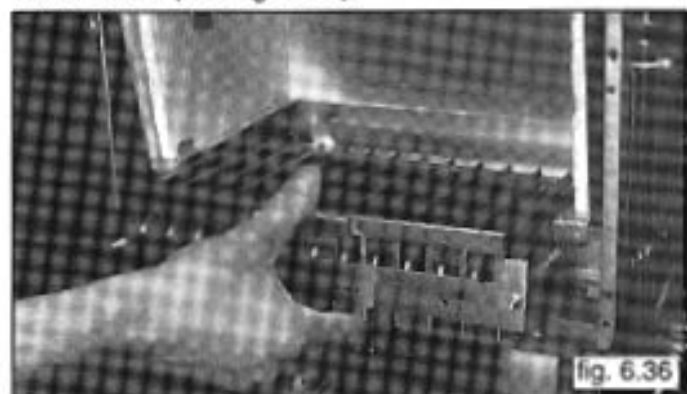

- 5 Remove the burner ( see fig. 6.36 );



- 6 Remove the nozzles using a No.7 socket spanner.  
Keep the washers ( see fig. 6.37 );

Reassemble in reverse order.

## Servicing instructions



**NOTE:** When you are replacing the nozzles to convert the appliance for use with a different type of gas, remember to replace the existing data plate ( under the instrument panel ) with the plate supplied in the modification kit ( see fig. 6.38 ) .

### 6.14 INSULATION PANELS

To replace the front insulation panel ( see fig. 6.39 )



1 To remove the combustion chamber cover ( sect. 6.2 ), hold the panel firmly and pull downwards. No other tool is required.

To replace the side insulation panel ( see fig. 6.40 )

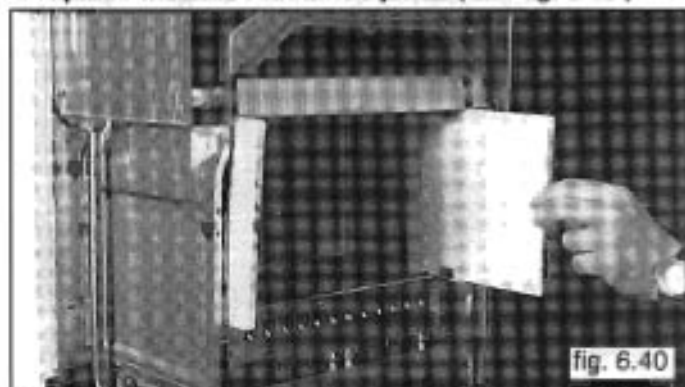

1 Remove the combustion chamber cover ( sect. 6.2 );  
2 Slide the side insulation panels forward;  
3 Replace in reverse order.

To replace the back insulation panel

1 Remove the combustion chamber cover ( sect. 6.2 );  
2 Dismount the hood together with the fan ( sect. 6.19 );  
3 Dismount the primary exchanger ( sect. 6.21 );  
4 Pull the panel up and slide it out;  
5 Reassemble in reverse order.

### 6.15 GAS MODULATOR CARTRIDGE

1 Ensure electricity is switched off at main isolator;  
2 Lower control panel ( sect. 6.2 );

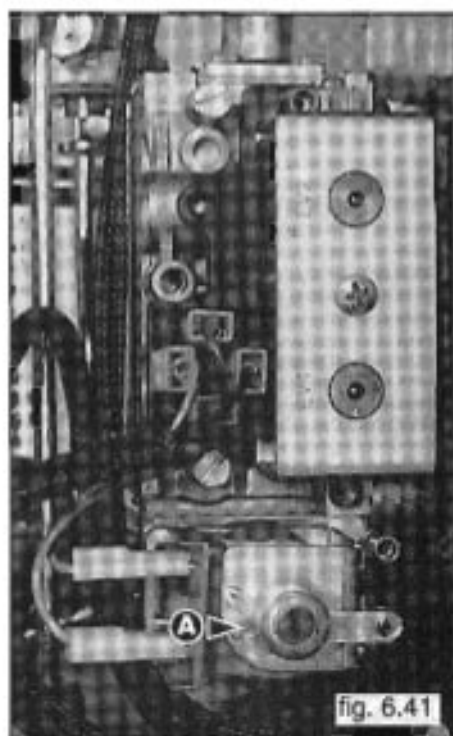

3 Turn the protection cap "A" and remove it from the adjustment control. Use a flat-edge screw driver to help removal ( see fig. 6.41 );



4 With a 14 mm spanner turn the cartridge "B" counter-clockwise ( see fig. 6.42 );



5 Remove the cartridge, but be very careful not to loose the internal components ( see fig. 6.43 );

6 Reassemble in reverse order.

# Servicing instructions

## 6.16 GAS MODULATOR COIL

- 1 Ensure electricity is switched off at main isolator;
- 2 Disconnect the two cables;
- 3 Lower the control panel ( sect. 5.2 );
- 4 Remove the gas modulator cartridge as explained in sect. 5.18;

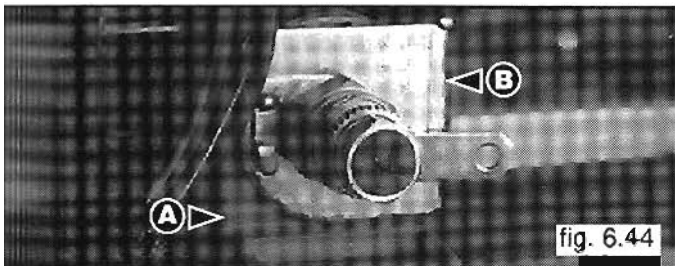

fig. 6.44

- 5 Slide the coil "A" and its housing from the valve ( see fig. 6.44 );
- 6 Remove the plate "B" ( see fig. 6.44 );



fig. 6.45

- 7 Slide the coil from its housing, being very careful not to loose spring "C" ( see fig. 6.45 );
- 8 Reassemble in reverse order.

## 6.17 ON-OFF OPERATOR COILS

- 1 Ensure electricity is switched off at main isolator;
- 2 Lower the control panel ( sect. 5.2 );

To remove the TANDEM operator coil

- 3 Disconnect the cables "B" ( see fig. 6.47 );
- 4 Unscrew the screw "A" and slide the TANDEM coils with its housing from the valve ( see fig. 6.47 );
- 5 Reassemble in reverse order.

## 6.18 GAS VALVE

- 1 Ensure electricity is switched off at main isolator;
- 2 Remove the cover and lower control panel ( sect. 5.2 );
- 3 Disconnect all the cables "B" ( see fig. 6.47 );
- 4 Remove the bottom plastic grid.
- 5 Remove the two screws "D" ( see fig. 6.48 ) by a Pozidrive n°2 star Inp screw driver;

- 6 Release the top nut "C" using a 30 mm open ended spanner ( see fig. 6.46 );
- 7 Reassemble in reverse order.

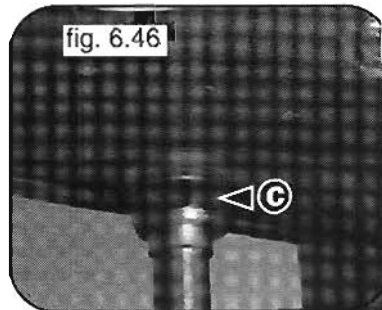

fig. 6.46

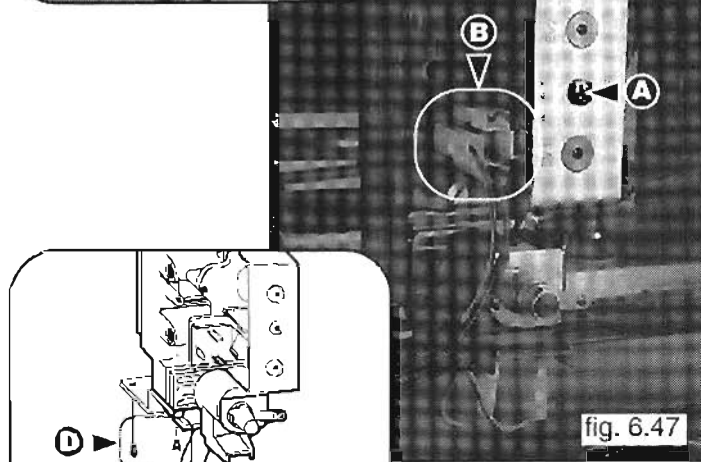

fig. 6.47

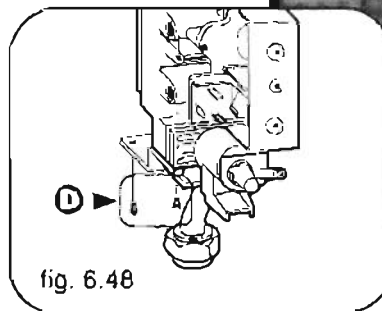

fig. 6.48

## 6.19 REMOVING THE FAN

- 1 Ensure electricity is switched off at main isolator;
- 2 Remove sealed chamber cover ( sect. 5.2 );

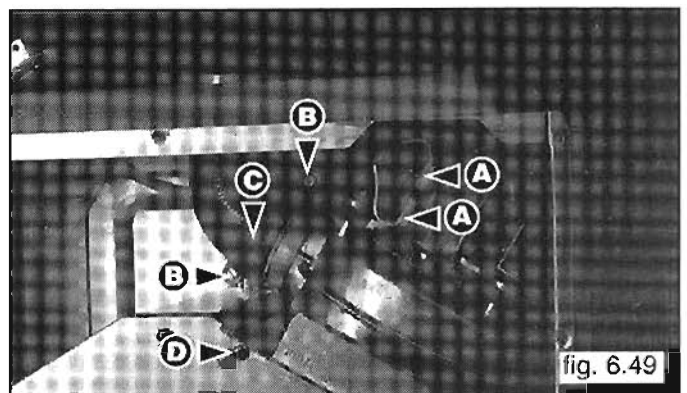
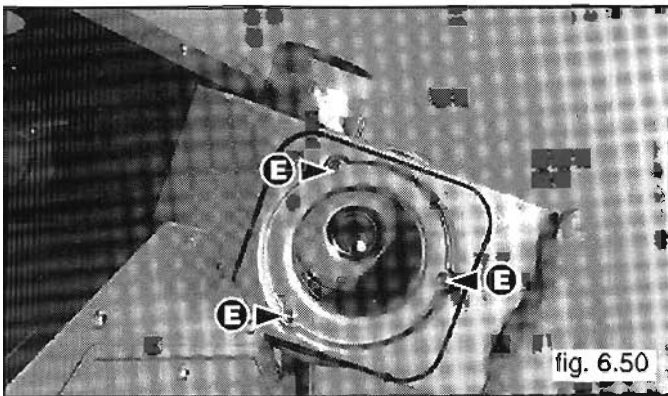

fig. 6.49

- 3 Disconnect electrical connections "A" ( see fig. 6.49 ).
- 4 Remove screws "B" using a flat tip screw-driver with a tip of at least 6.5 mm ( see fig. 6.49 );
- 5 Remove clamp "C" ( see fig. 6.49 );
- 6 Remove screws "D" ( the left one indicated ) ( see fig. 6.49 );
- 7 Pull fan forward and remove;

## Servicing instructions



8 Remove screws "E" using a POZI-DRIVE No.2 star tip screw-driver ( see fig. 6.50 );

9 Remove fan from mounting plate;

10 Reassemble in reverse order.

Ensure that the silicone seal is in good order.  
If necessary replace the seal.

### 6.20 AIR PRESSURE SWITCH

1 Ensure electricity is switched off at main isolator;

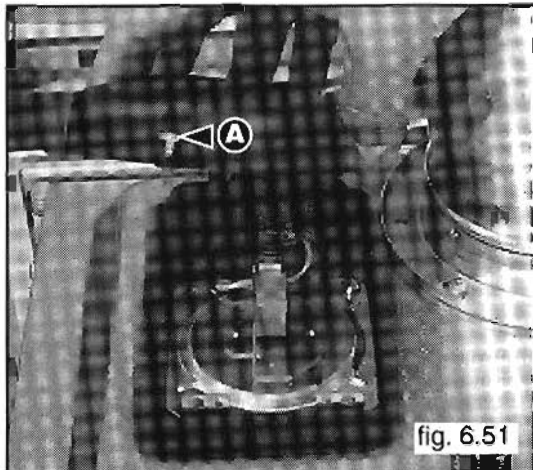

2 Remove screw "A" using a POZI-DRIVE No.2 star tip screw-driver ( see fig. 6.51 ); Rotate the cover upwards.

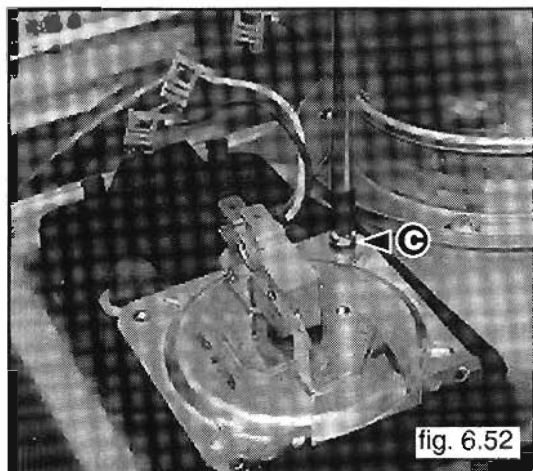

3 Remove screw "c" using a POZI-DRIVE No.2 star tip screw-driver ( see fig.6.52 );

4 Disconnect the cables, marking in reference points which will help you when you reassemble the part ( see fig. 6.52 );

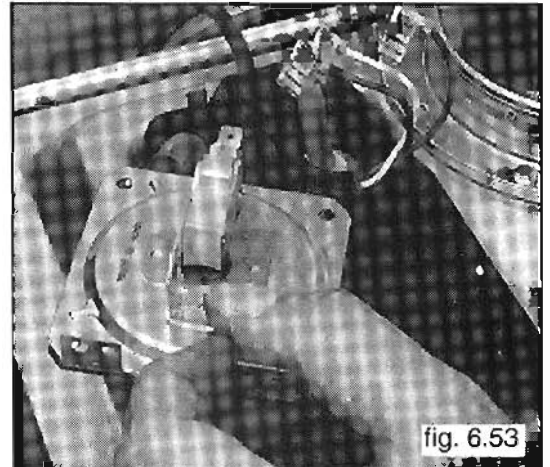

5 Lift the air pressure switch and remove tubes ( see fig. 6.53 );

6 To reassemble, follow the above steps in reverse order.

### 6.21 MAIN HEAT EXCHANGER

1 Ensure electricity is switched off at main isolator;

2 Drain boiler ( sect. 6.3 );

3 Remove sealed chamber cover and open the combustion chamber ( sect. 6.2 );

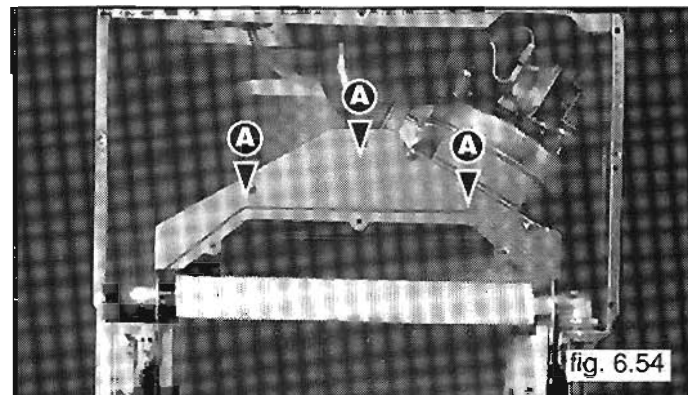

4 To remove the front panel of the flue hood, unscrew the 3 screws "A" using a POZI-DRIVE No.2 star tip screw-driver ( see fig. 6.54 );

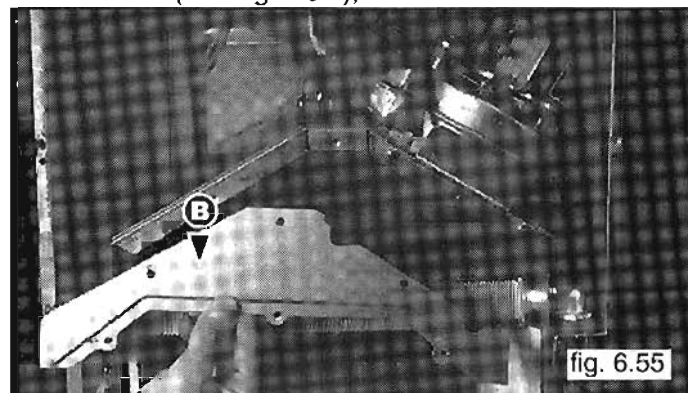

5 Remove the front panel of the hood "B" ( see fig. 6.55 );



# Servicing instructions

## 6.22 AUTOMATIC AIR PURGER

1 Ensure electricity is switched off at main isolator;

2 Drain boiler ( sect. 6.3 );

3 Unscrew valve "A" ( see fig. 6.59 );

4 Reassemble in reverse order.

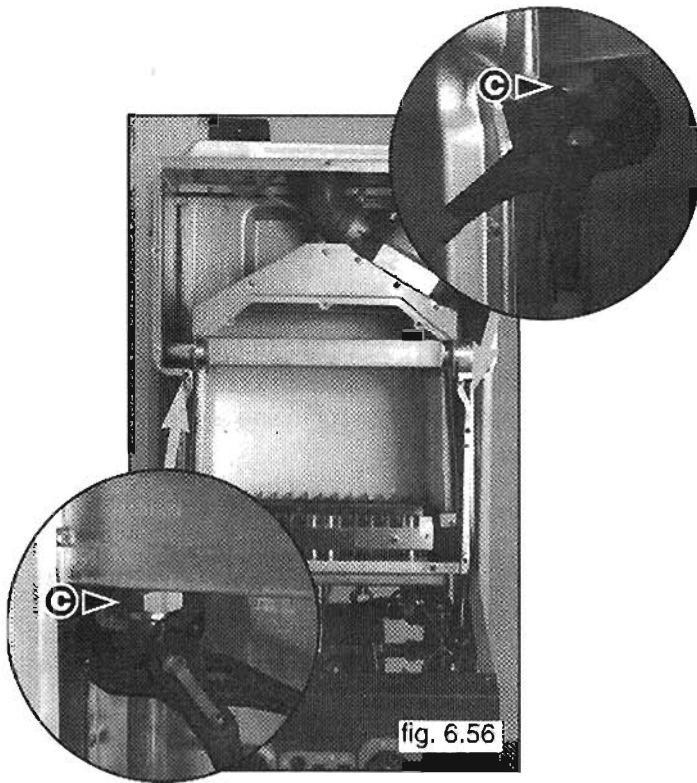

fig. 6.56

6 Release nuts "C" ( see fig. 6.56 );

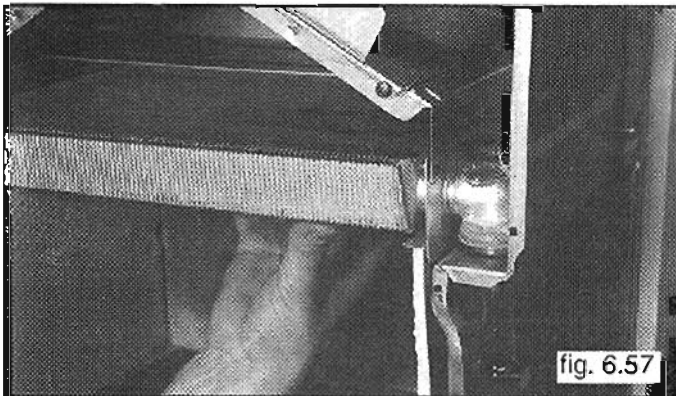

fig. 6.57

7 Lift the exchanger in order to release the attachments from their housing ( see fig. 6.57 );

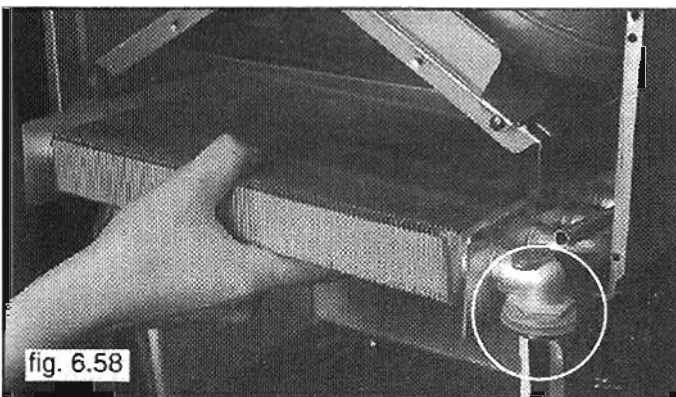

fig. 6.58

8 Pull it straight out ( see fig. 6.58 );

9 Keep the gaskets ( see fig. 6.58 ).

Reassemble in reverse order.

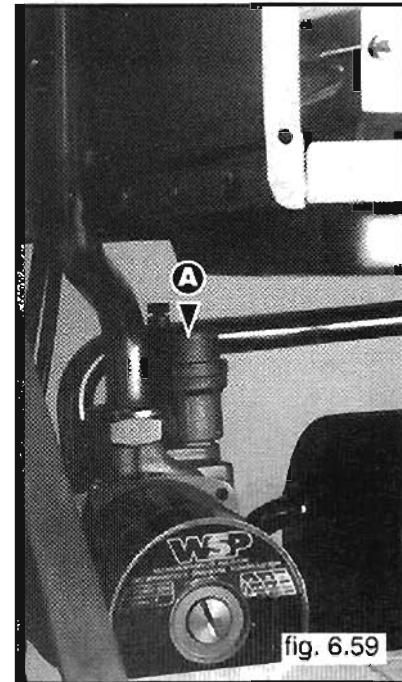

fig. 6.59

## 6.23 PUMP

1 Ensure electricity is switched off at main isolator;

2 Drain boiler ( sect. 6.3 );

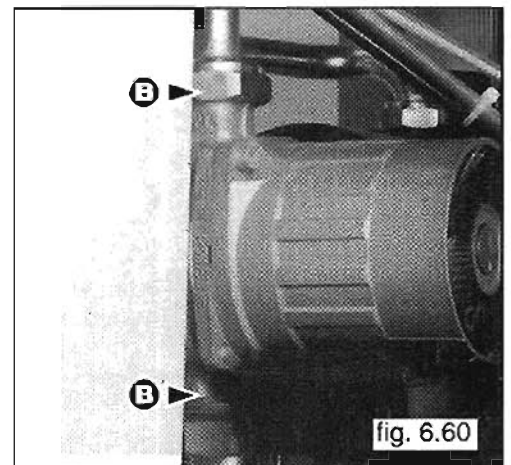

fig. 6.60

3 Release nuts "B" using a 36 mm open ended ( see fig. 6.60 );

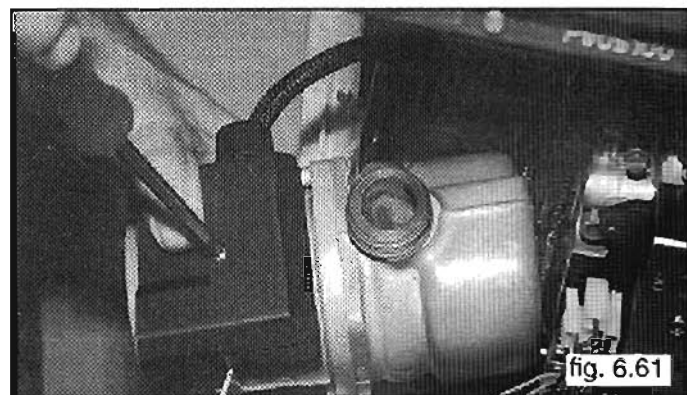
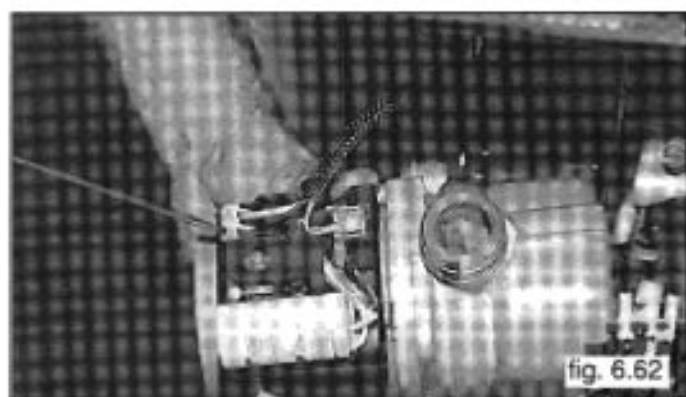

fig. 6.61



## Servicing instructions



4 Disconnect electrical connections ( see fig. 6.61, 6.62, 6.63 ).

5 Reassemble in reverse order.

### 6.24 PUMP PRESSURE SWITCH

1 Ensure electricity is switched off at main isolator;

2 Drain boiler ( sect. 6.9 );

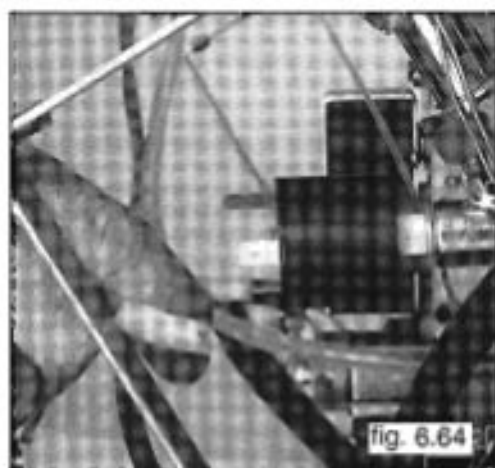

3 Disconnect electrical wires ( see fig. 6.64 );



4 Remove pump pressure switch using a 17mm open ended ( see fig.6.65 );

5 Reassemble in reverse order.

### 6.25 TEMPERATURE PRESSURE GAUGE

1 Ensure electricity is switched off at main isolator;

2 Remove the cover and lower the control panel ( sect. 6.2 );

3 Drain boiler ( sect. 6.9 );



4 Release coupling "A" using a 14 mm open ended ( see fig.6.66 );

5 Remove the clamps joining the capillary to the electric cables;

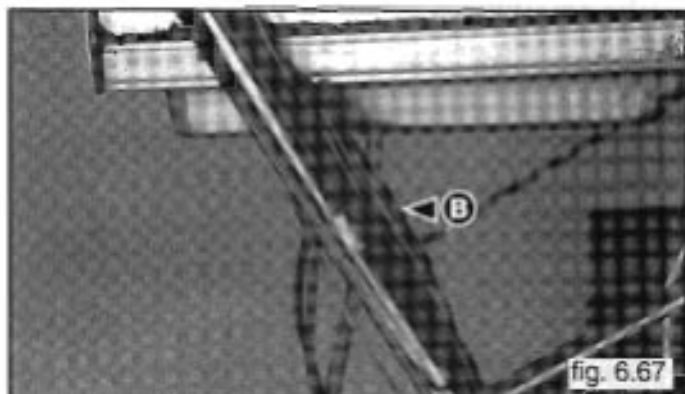

6 Remove spring "B" ( see fig.6.67 );

# Servicing instructions

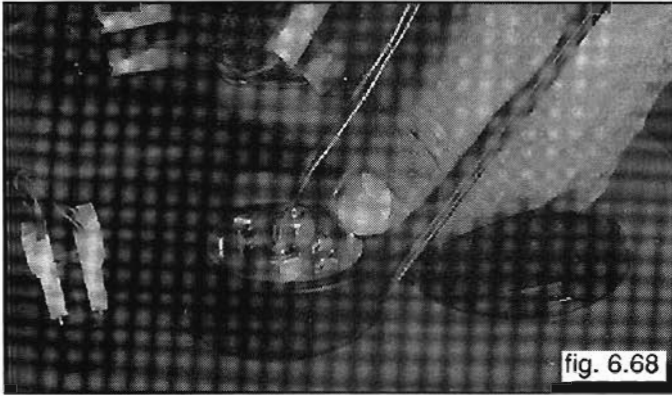

fig. 6.68

- 7 Push on the Instrument from the interior to the exterior ( see fig. 6.68 );
- 8 Reassemble in reverse order.

## 6.26 REMOVING DIVERTOR VALVE

- 1 Ensure electricity is switched off at main isolator;
- 2 Shut the mains water tap;
- 3 Drain boiler ( sect. 6.3 );
- 4 Drain d.h.w. section ( sect. 6.4 );
- 5 Dismount the microswitches as shown in sect. 6.12;
- 6 Release all the coupling nuts using No.20,30 and 36 Open ended spanners ( see fig.6.69 );
- 7 Reassemble in reverse order.

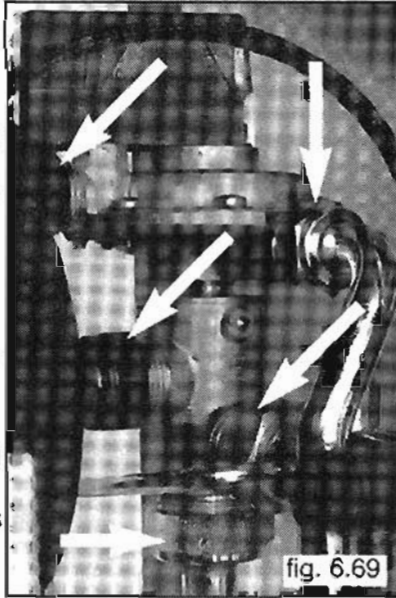

fig. 6.69

Ensure that the flat packing is in the correct position.

## 6.27 SECONDARY EXCHANGER

- 1 Ensure electricity is switched off at main isolator;
- 2 Drain boiler ( sect. 6.3 );
- 3 Drain d.h.w. section ( sect. 6.4 );
- 4 Remove the gas valve ( sect. 6.18 );

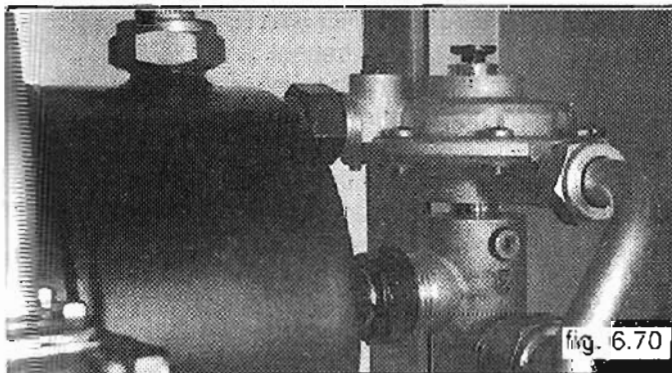

fig. 6.70

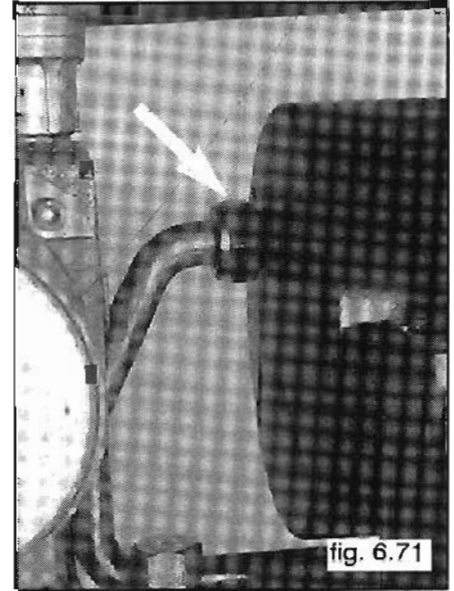

fig. 6.71

- 5 Release all the nuts as shown in figures 6.70 & 6.71 , using No.24 and 36 Open ended spanners;
- 6 Remove exchanger vessel through the front of the boiler;
- 7 Reassemble in reverse order.

## 6.28 EXPANSION VESSEL

- 1 Ensure electricity is switched off at main isolator;
- 2 Drain boiler ( sect. 6.3 );
- 3 Disconnect flue;

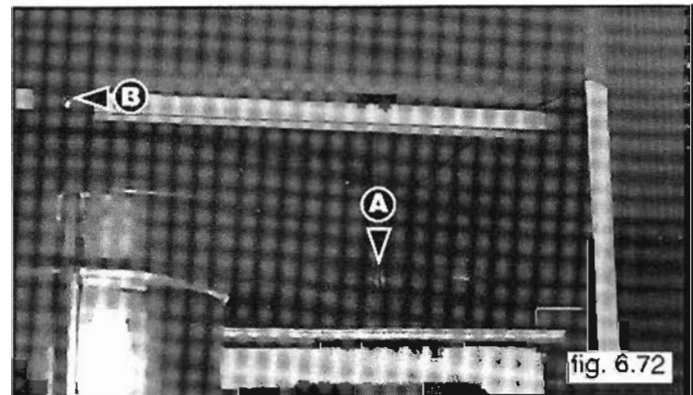

fig. 6.72

- 4 Remove nut "A" away from the expansion vessel ( see fig.6.72 );
- 5 Remove screw "B" using a POZI-DRIVE No.2 star tip screw-driver (see fig.6.72 );
- 6 Lift expansion vessel up from the boiler;
- 7 Reassemble in reverse order.

If there is not adequate clearance the boiler must be removed from the wall before the removal procedure can be carried out.

---

---

## ***Servicing instructions***

---

---

### **6.29 SAFETY VALVE**

1 Ensure electricity is switched off at main isolator;

2 Lower control panel ( sect. 6.2 );

3 Drain boiler ( sect. 6.3 );

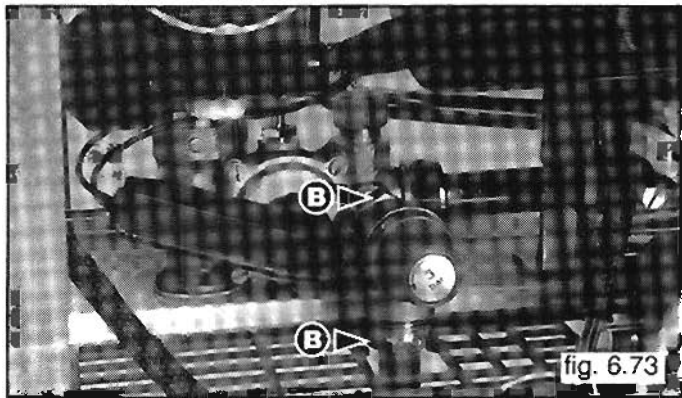

4 Loosen nuts B (see fig.6.73);

5 Remove valve;

6 Reassemble in reverse order

## 7 FAULT FINDING

### 7.1 TOTAL CHECK SYSTEM ( TCS )

The TOTAL CHECK SYSTEM ( which will be referred to as "TCS" ) is designed to locate faults quickly and easily. ( see fig.7.1 ).



fig. 7.1

This device makes it possible to check the proper functioning of the electronic PCBs and components these control, it is connected to the PCB via the cable which you will see is folded back inside the TCS.

The TCS indicates:

- The actual state of the boiler;
- The eventual fault.

The informations given by the TCS are as follows ( see fig.7.2 ):

a) n°2 LEDS EACH SIDE OF THE DIASPLAY:

- green LED : the boiler work properly;
- red LED : the boiler has a fault.

b) DISPLAY SHOWING :

- the actual state of the boiler according to the following numbers:

- \*0\* Boiler off
- \*1\* Autodiagnostic state
- \*2\* Spark ignition stage
- \*3\* Boiler functioning normally
- \*4\* Lockout
- \*5\* Boiler thermostat satisfied
- \*6\* Room thermostat/clock no demand or selector in summer setting

- the actual faults according to the following letters:

- "A" Faulty ventilation system
- "B" Air pressure switch stuck in N.O. position
- "C" Faulty reset switch
- "D" Faulty main circuit flow
- "E" Faulty flame detection
- "F" N.A. for this model
- "G" N.A. for this model

c) n°8 YELLOW LEDS UNDER THE DISPLAY SHOWING THE ACTUAL STATE OF THE MAIN COMPONENTS:

- led 1 : Pump feeded
- led 2 : Main flow switch closed
- led 3 : Air pressure switch N.O.
- led 4 : Flame detected
- led 5 : Water at required temperature
- led 6 : Room thermostat/clock no demand or selector in summer setting
- led 7 : Autodiagnosics faulty
- led 8 : N.A. for this model

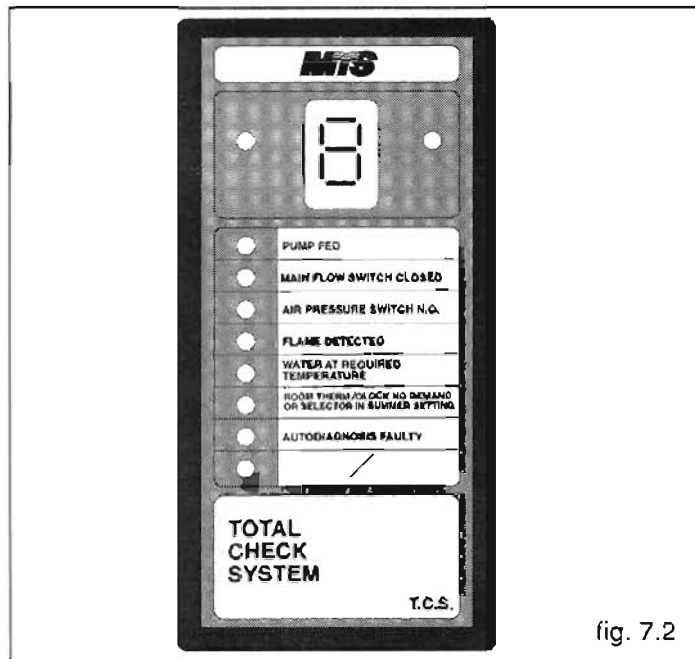

fig. 7.2

**Note:** During the operation of the TCS, faults may be signaled by the red LED and a letter in the display for short periods ( one second or less ), this is normal and does not signify these faults.

### 7.2 SPECIAL DEFECTS

There are special defects that can not been indicated by the TCS; these defects are treated in the following sections:

- Water leaks;
- Difficulty in lighting gas;
- Incorrect combustion;
- Traces of gas or exhaust gases in the installation area.

#### 7.2.1 WATER LEAKS

##### Leaks from connectors, O-Rings or gaskets

Make sure that the surfaces which come into contact with the gaskets are free from dirt, roughness or deformation. Then substitute the gasket ( both O-rings and flat gaskets).

##### Water leaks from safety valve

This may be caused by leaks from the d.h.w. over-pressurizing the heating circuit. In this case remove the d.h.w. heat exchanger and replace it.

If the leak only occurs when the appliance is operating, empty the main water circuit and check the pressure applied to expansion vessel ( 1.2 bar ).

#### 7.2.2 DIFFICULTY IN LIGHTING THE BURNER

Make sure that input and output pressures on the gas valve are set to the correct values.

Also, make sure that no pressure variations are being caused by a malfunctioning component ( defective pressure reducers or regulator; dirty gas filters; other gas consuming equipment installed on the same gas line, etc. ).

# Fault finding

**TCS STATE : All lights in the TCS are off while the main switch is on position "ON"**

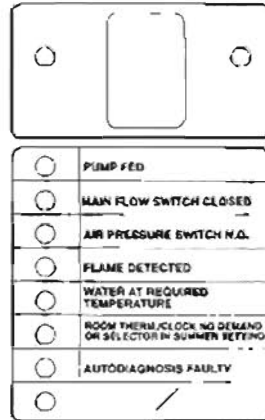

Verify preliminary that the installation of the TCS has been made properly according to the par. 7.3 and that the main switch of the boiler is on position "on" (neon light).

Yes

Is the overheat thermostat actuated?

Yes

- Try to reset the thermostat (Ref.1) or replace it if needed. The overheat thermostat is a security device that can switch off very rarely. If there are continuous interventions, it means that:
- Or the temperature regulating probes are faulty or disconnected (Ref.2) and replace if needed;
- Or the main heat exchanger is faulty due to the formation of scales or to some deposit of corrosion from the plant. In this case clean the heat exchanger according to par. 6.21 or replaced it;
- Or the fins of the main heat exchanger are not well welded to the tube; in this case all the area of not welded fins assume a black colour. Replace the heat exchanger according to par. 6.21.
- Or the PCB is faulty. In this case replace it.

No

Is the minimum water pressure switch open?

Yes

- Fill the main heating circuit according to par. 4.4. Till the pressure activates the switch in the closed position.
- If not, replace the pressure switch (Ref.A).

No

- Replace the fuses 2 A ( see Ref.3).
  - Locate the cause of fusing, disconnecting the components connected to the PCB and measuring their electric resistance ( set tester to Ohm ).
- The rating values are:
- Pump : 190 Ohm
  - Fan : 45 Ohm
  - Control gas operators . EV1 = 870 Ohm  
EV2 = 870 Ohm  
Modulator = 127 Ohm

# Fault finding

**Ref.1**  
Try to reset the overheat thermostal.

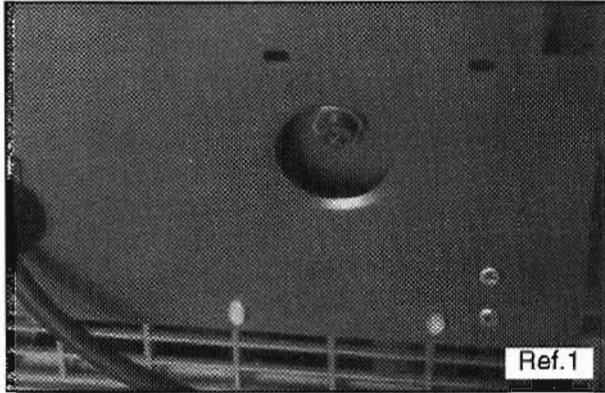

**Ref.3**  
Replace the fuses 2A

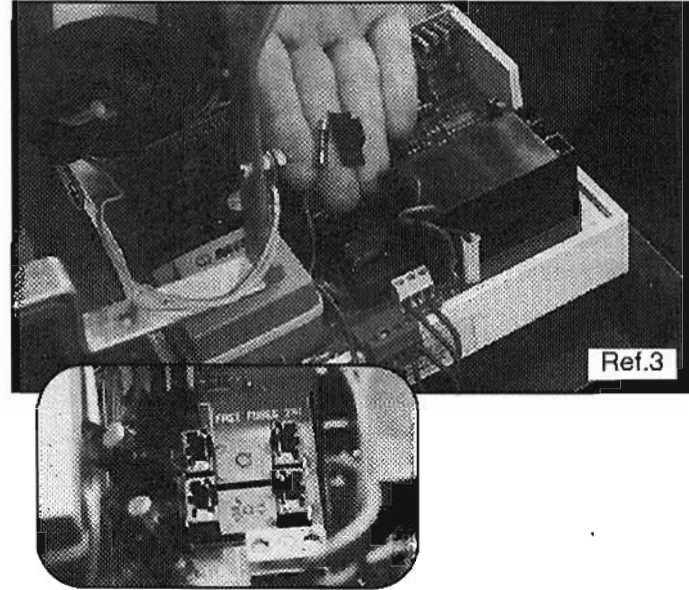

**Ref.2**  
Verify the resistance of both heating and sanitary hot water probes.  
The resistance must be according to the following table:

WATER TEMPERATURE (DEGREES)	RESISTANCE ( $\Omega$ )
30	8.170
35	6.750
40	5.750
45	4.750
50	4.240
55	3.470
60	2.950
65	2.600
75	1.900
80	1.865
85	1.442
90	1.202

Ref.2

**Ref.4**  
Verify if the minimum water pressure switch is in the closed position.  
Set the tester to Ohm.

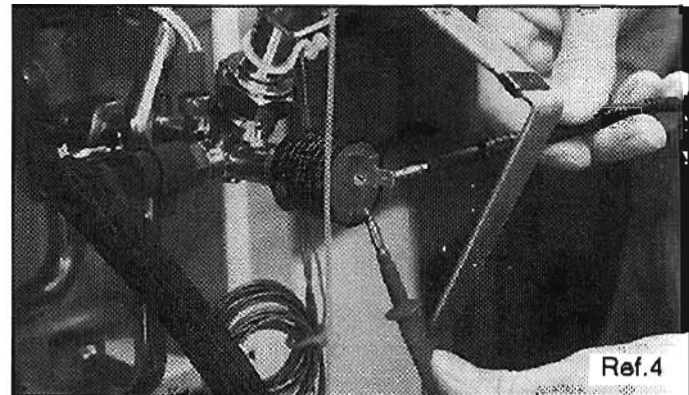

# Fault finding

## TCS STATE : Ventilation faulty

( letter "A" appears at the end of the autodiagnosis if ventilation is faulty )

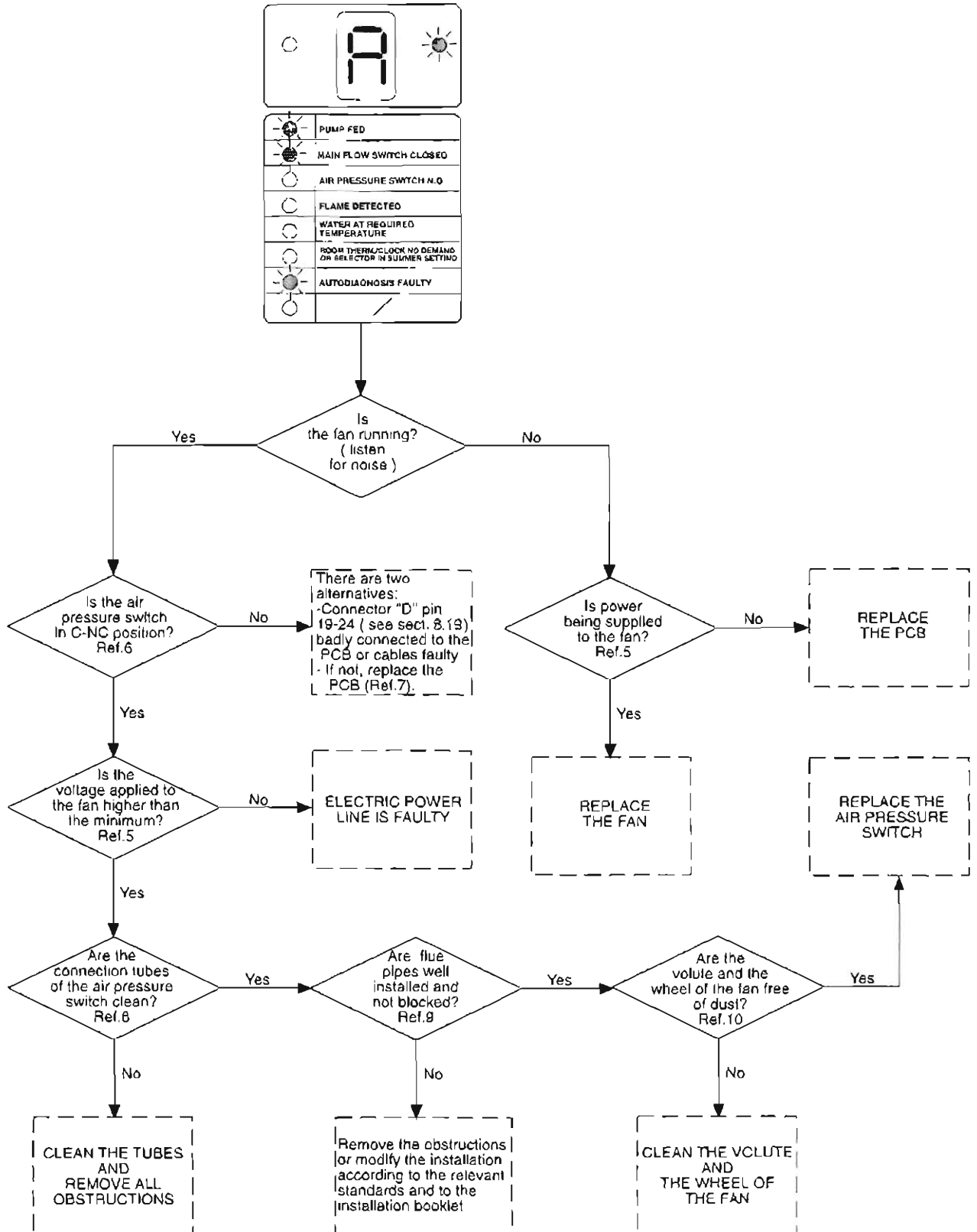



## Fault finding

### Ref.5

Supply voltage ( 230 VAC  $-10\% \div +15\%$  ) should be indicated by terminals of the fan.  
Set the tester to VAC.



### Ref.6

Verify that C and NC connectors of the air pressure switch are closed, measuring the resistance between them that must be zero.  
Set the tester to Ohm.

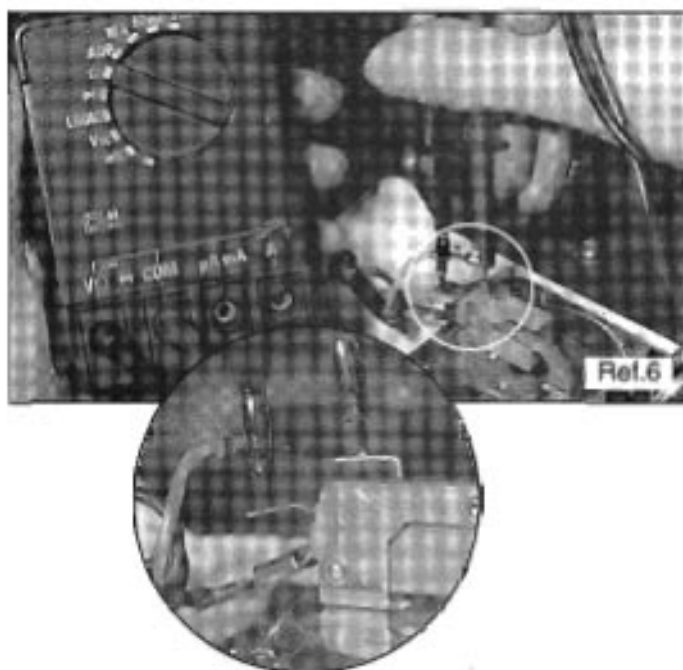

### Ref.7

Verify that the connector D is properly fitted to the PCB terminal and that the cables are not damaged.



### Ref.8

Verify that the No.2 siliconic transparent static pressure tubes are free of dust or condensate and that also the 'venturi' is not occluded.

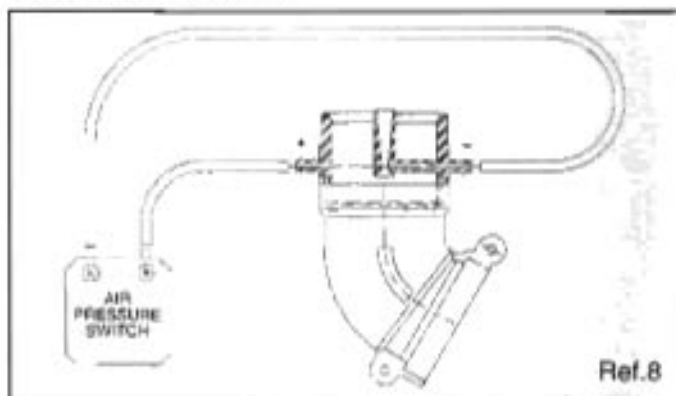

### Ref.9

Verify the flue pipes and the terminal as follows:

- They are installed according to the relevant standards;
- The diameter of the flue pipes, the total length and the number of the elbows are according to the installation booklet;
- There are no obstructions inside the flue pipes;
- There are no obstructions in the outside openings air inlet and flue gas discharge.

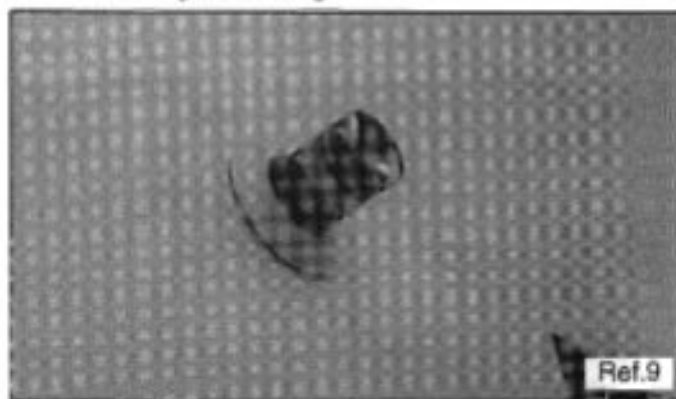

### Ref.10

Do as follows:

- Remove the fan according to the sect. 6.12 of the installation booklet;
- See from the section opening of the fan if there is enough dust to reduce the rate of flow.





# Fault finding

## TCS STATE : Air pressure switch stuck in C-NO position

( letter "B" appears during the autodiagnosis if the air pressure switch indicates ventilation before the fan is activated )

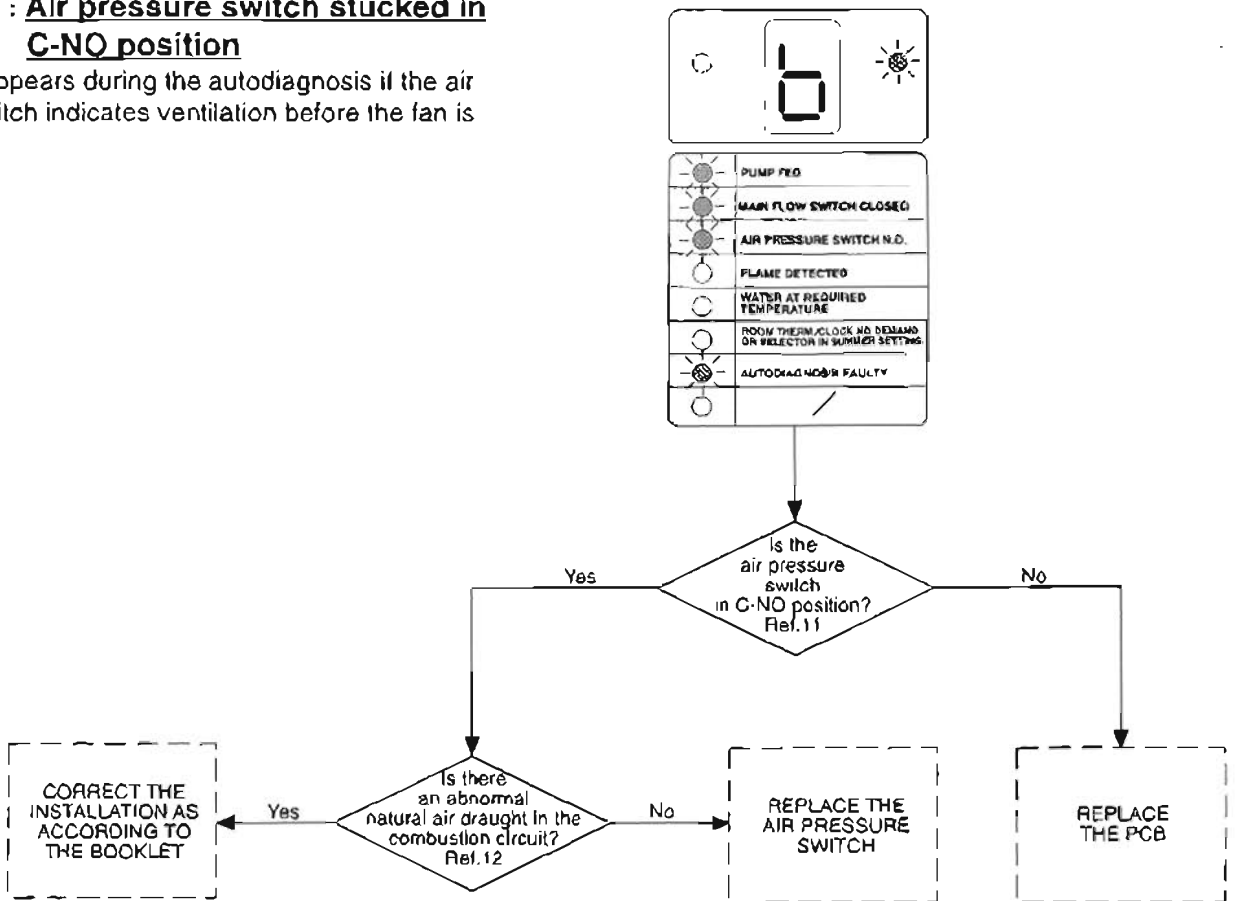

## TCS STATE : Resetting switch pressed

( letter "C" appears during the autodiagnosis if the reset switch is pressed or in short circuit )

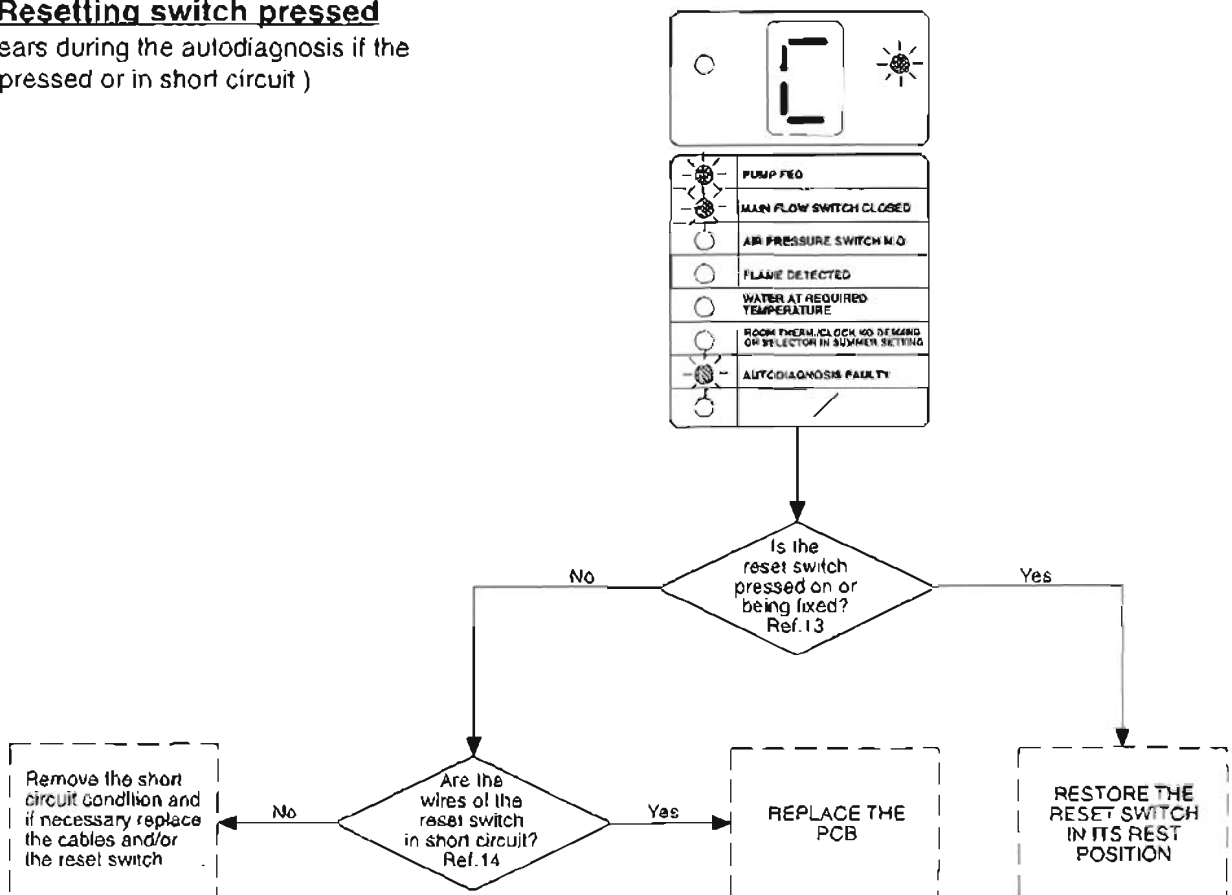

## Fault finding

### Ref.11

Verify that C and NO connectors of the air pressure switch are closed, measuring the resistance between them that must be zero.

Set the tester to Ohm.

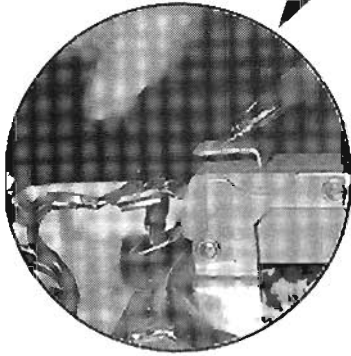

### Ref.12

Verify the flue pipes and the terminal as follows:

- they are installed according to the relevant standards;
- they are installed according to the installation booklet mainly as it concerns the need of an orifice when the total length is lower to a given value.

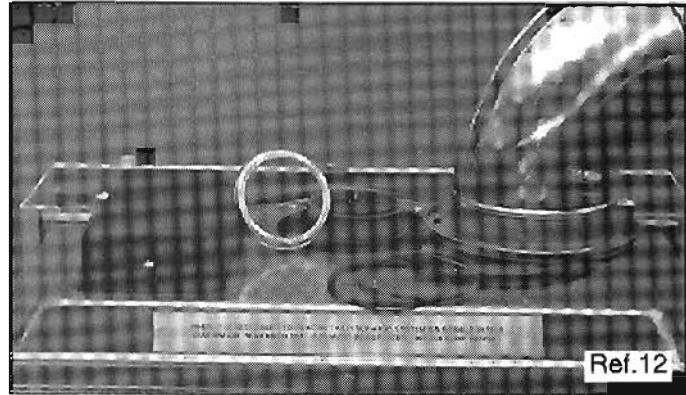

### Ref.13

The check can be done just visually.

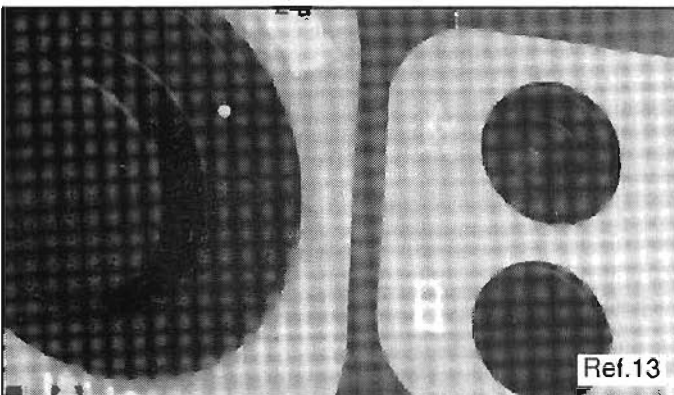

### Ref.14

Verify that the resistance between the two pins is infinity.

Set the tester to Ohm.

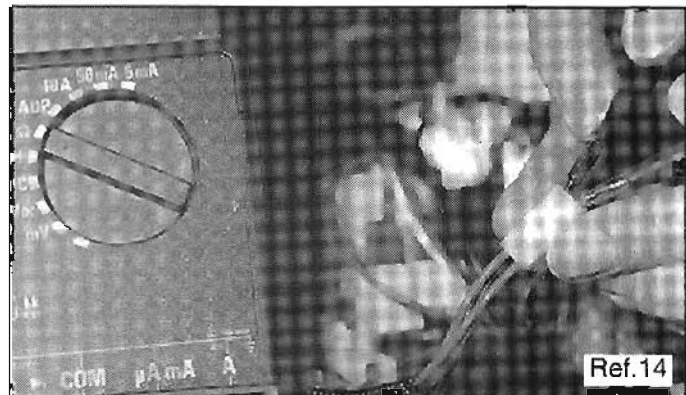

# Fault finding

## TCS STATE : **Main water flow faulty**

( letter "D" appears before the autodiagnosis:  
 (two cases are possible depending from the led lighting)

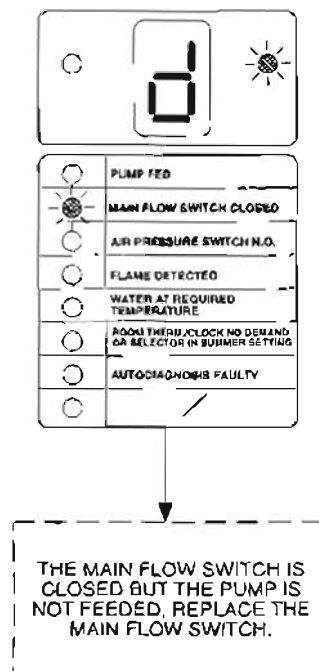
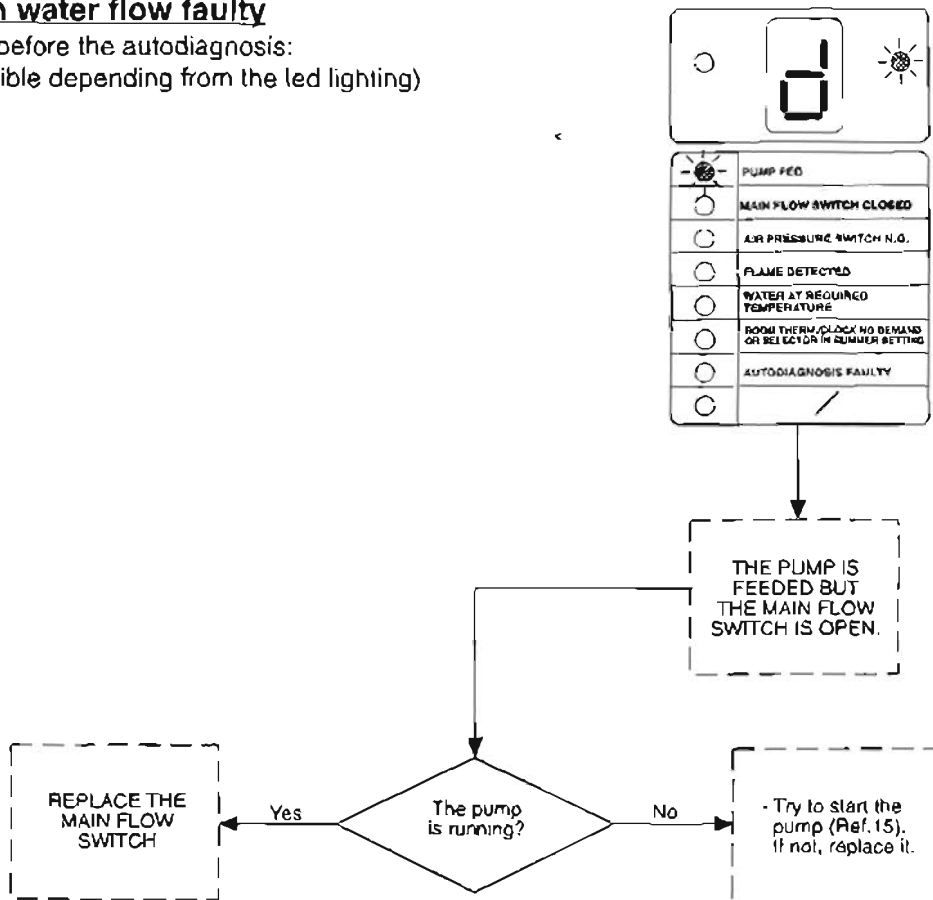

---

## ***Fault finding***

---

Ref.15

Remove the screw cap and then turn the shaft of the pump in clockwise direction.

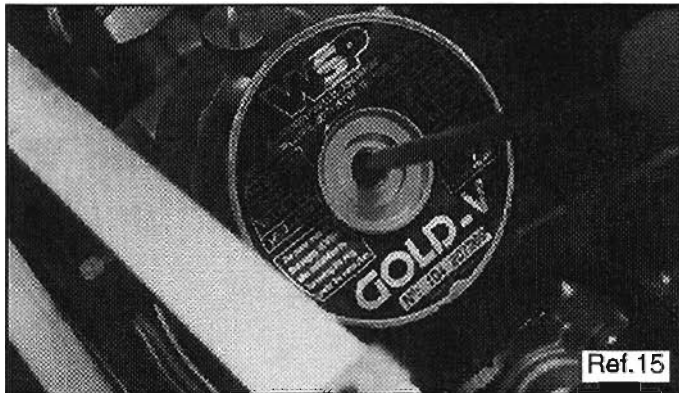

# Fault finding

## TCS STATE : Faulty flame supervision device

( letter "E" appears during the autodiagnostic if there is a supervised flame before opening the gas valve )

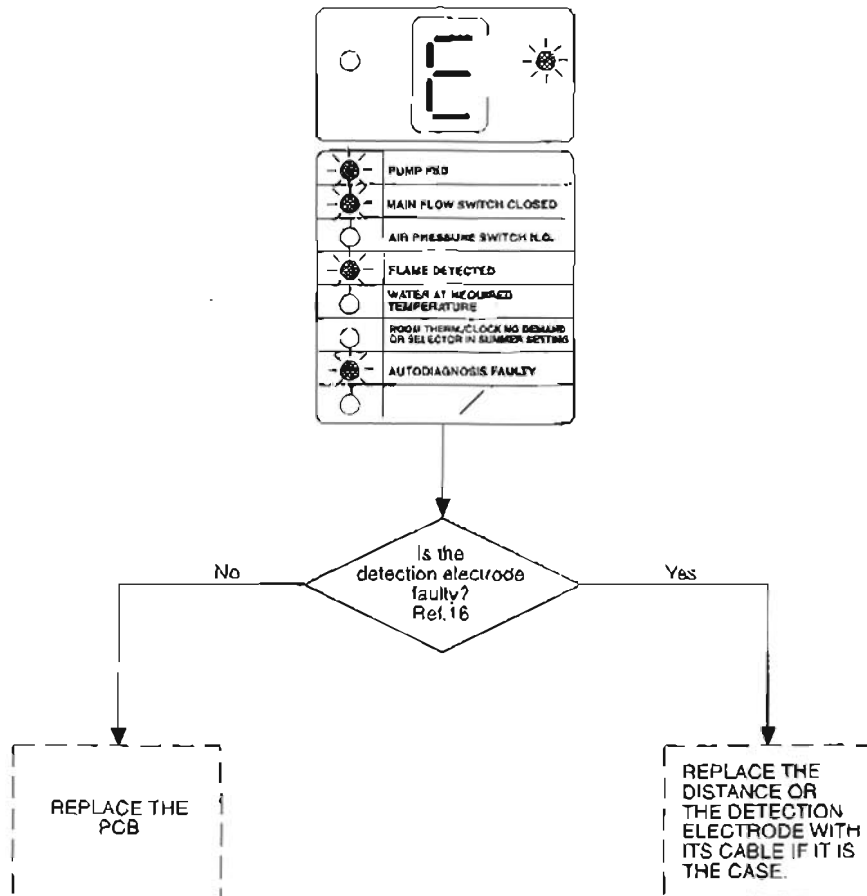

## Fault finding

### Ref.16

Verify the distance of the terminal of the detection electrode to the burner; it should be about  $5 \div 7$  mm ( see Fig. Ref.11-a ).

Set the tester to DC (  $\mu$ A ).

The tester should be connected in serie with the detection circuit ( see Fig. Ref.11-b ).

The value of detection current without flame must be lower than  $0.5 \mu$ A.

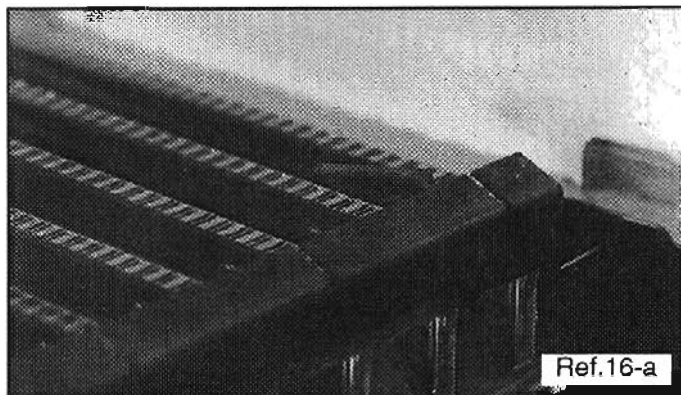



# Fault finding

## TCS STATE : Lockout ( red light on the reset push button )

( number "4" appears if the flame is not detected:  
 1 - or at the end of a complete ignition sequence;  
 2 - or when, as a consequence of a disappearance of the flame without the gas supply having been interrupted, the ignition device fault ).

**Note: A single lockout is a not default; just repetitive lockout are a default.**

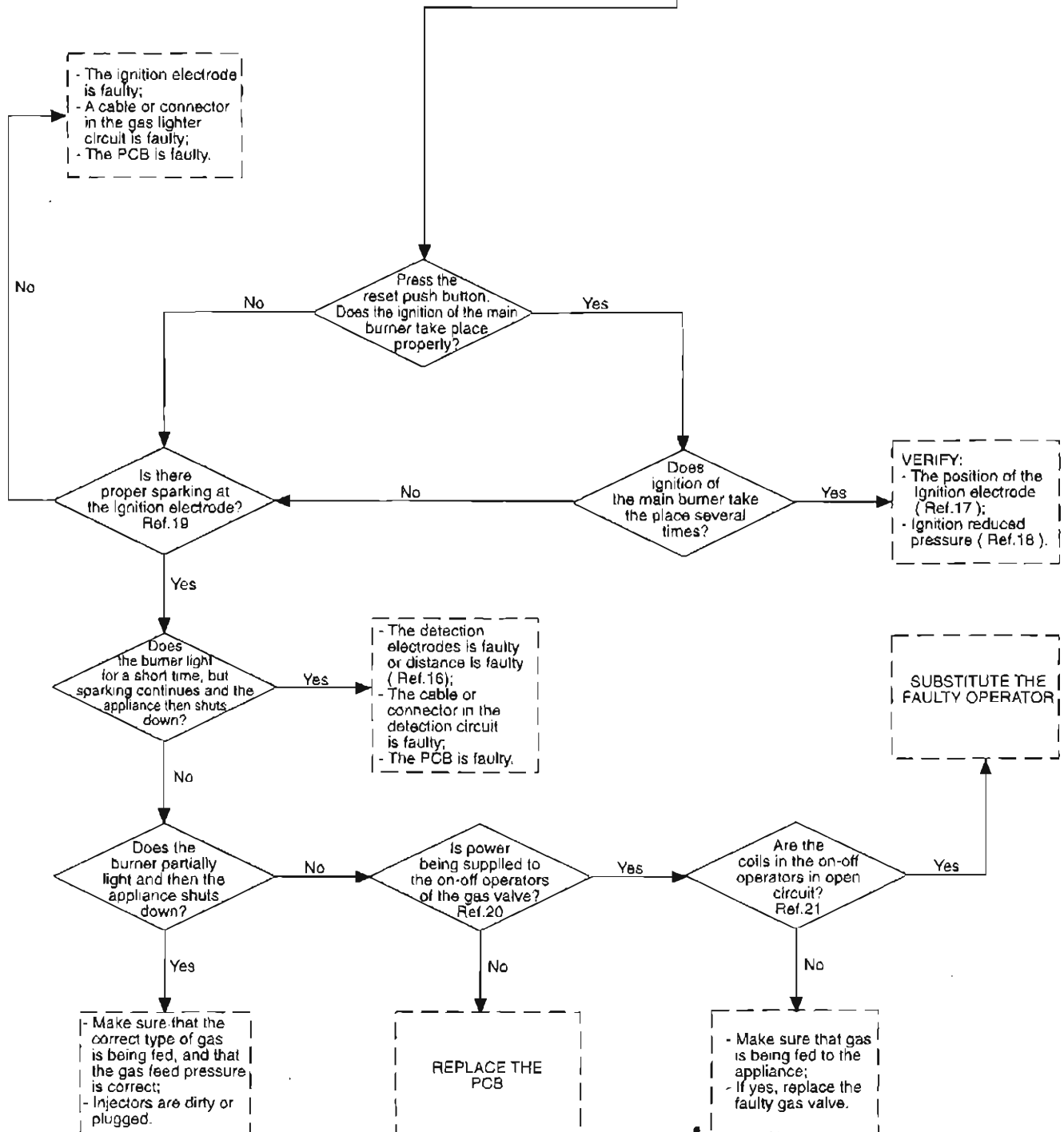
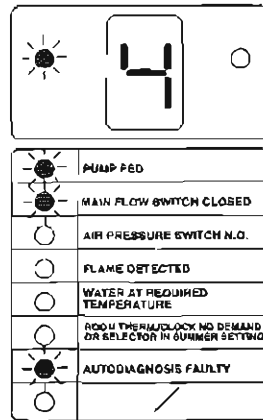

## Fault finding

### Ref.17

Verify that the distance between the terminal of the ignition electrode and the burner is about 5 mm.

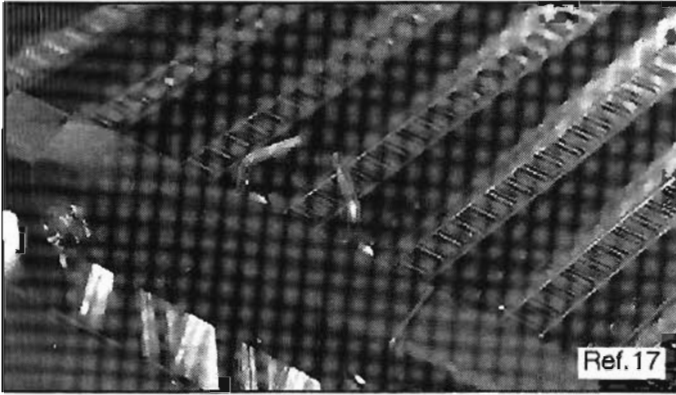

### Ref.18

Install a manometer in the outlet pressure intake of the gas valve.  
Remove the detection electrode and activate an ignition cycle.  
During this attempt the ignition, gas pressure can be measured.  
Verify that this value is according to the installation booklet.

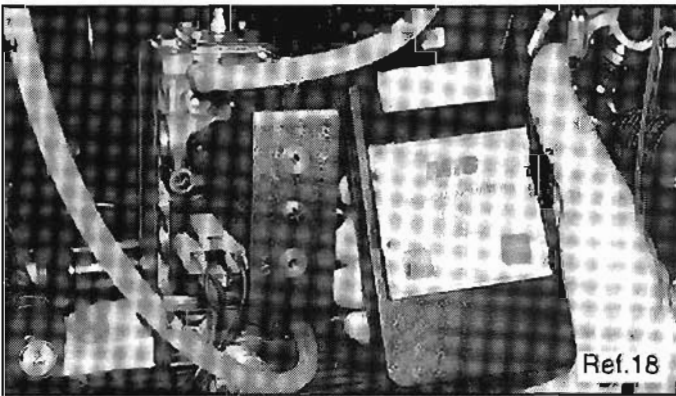

### Ref.19

Verify visually that sparks are on the burner and distance is according to ref.17.

### Ref.20

Supply voltage should be indicated when power is supplied to the operators.  
Make measurements with the device reset from shut-down.  
Set the tester to VAC.

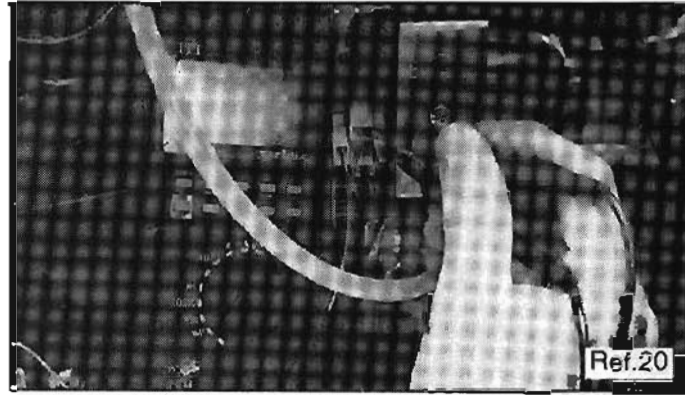

### Ref.21

To check the coil in the on-off operators, disconnect the winding from its circuit and measure the resistance; it must be not infinity.

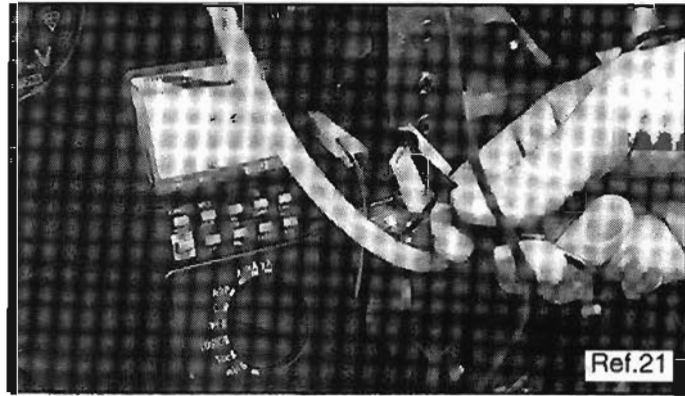

# Fault finding

**TCS STATE : There is no demand of heat due to the internal regulations of the boiler**

**Note:** This state is faulty only if it remains indefinitely, even when space heating or domestic hot water are expected.

Chw : Central heating water

Dhw : Domestic hot water

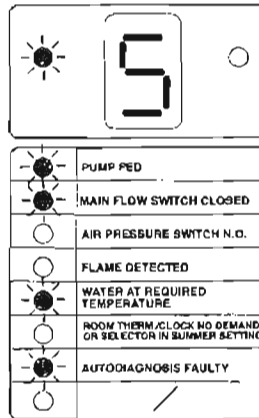

- In case of space heating, put the Chw potentiometer to its maximum and wait till the temperature is lower then required;  
 - In case of domestic hot water be sure that the flow rate of the drawing is greater than 2.8 litres/minute.

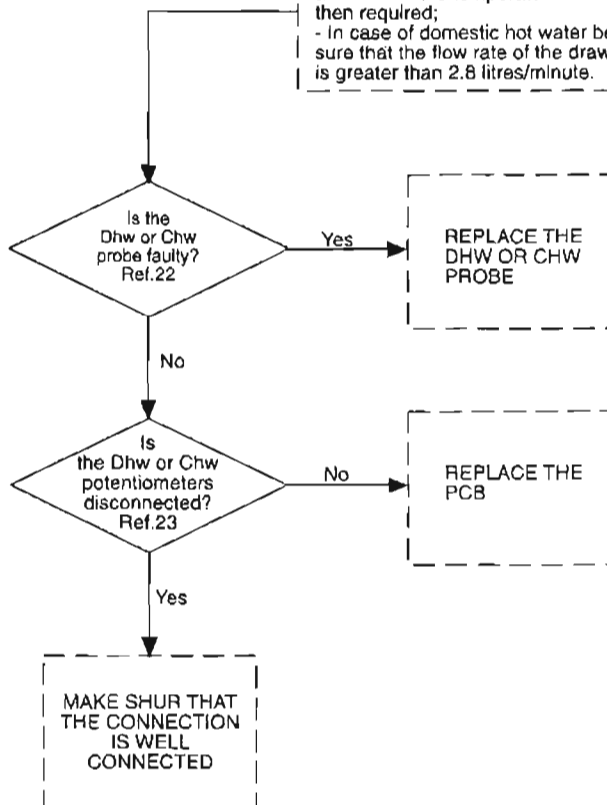

---

## *Fault finding*

---

Ref.22

Disconnect the terminals of the probe and make measurements of the resistance. Set elster to Ohm. The valve must be according to those of Ref.2

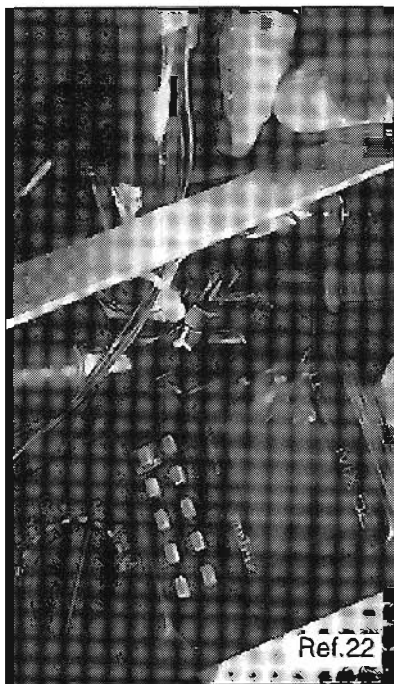

Ref.23

Verify visually if the connector to the potentiometer is well connected.

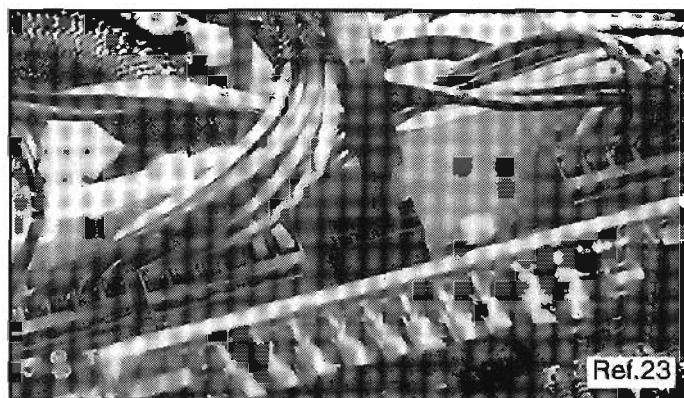

# Fault finding

**TCS STATE : There is no demand of heat due to the external regulations of the boiler or boiler is switched on "summer" position.**

**Note:** This state is faulty only if it remains indefinitely, even when space heating or hot water are expected.

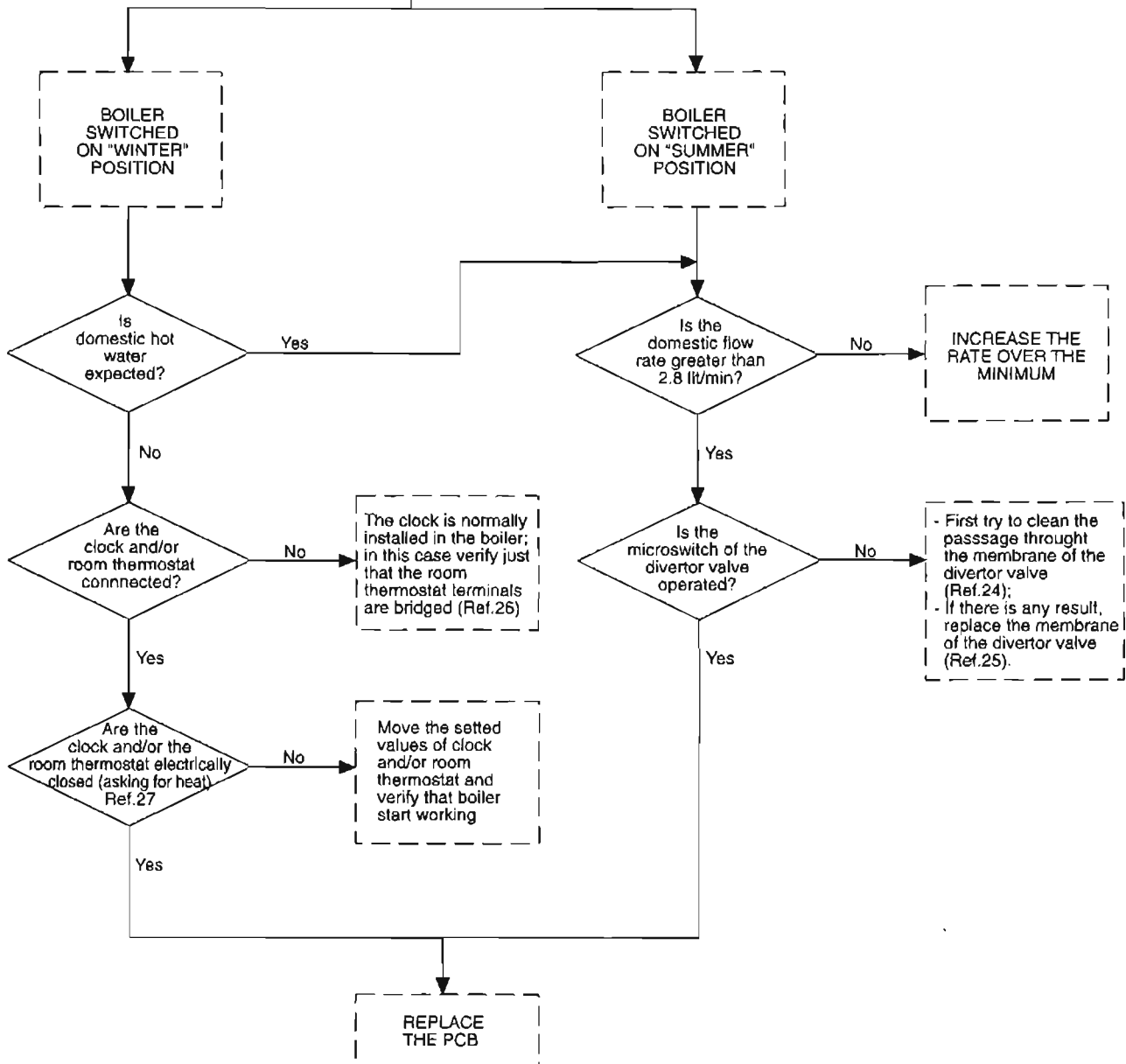
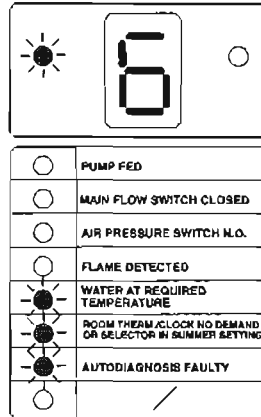

## Fault finding

### Ref.24

Do as follows:

- Increase the domestic water flow rate to the maximum;
- Push back the shaft of the diverter (with a tool); wait some seconds.

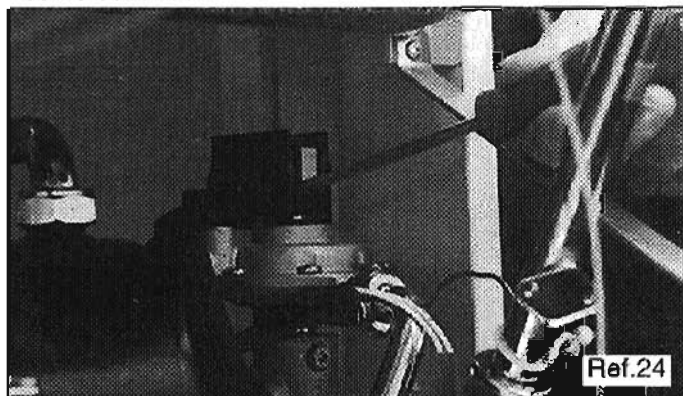

### Ref.27

Measure the resistance between the terminals of the clock and /or the room thermostat.

The value must be zero.

Set the tester to Ohm.

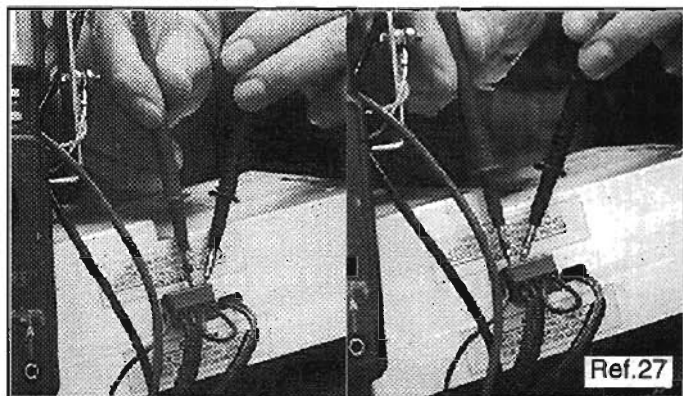

### Ref.25

- Switch off the domestic inlet cock;
- Remove the 8 screws;
- Unloose the nut connecting the diverter valve to the sanitary heat exchanger;
- Dismount the brass up and replace the membrane.

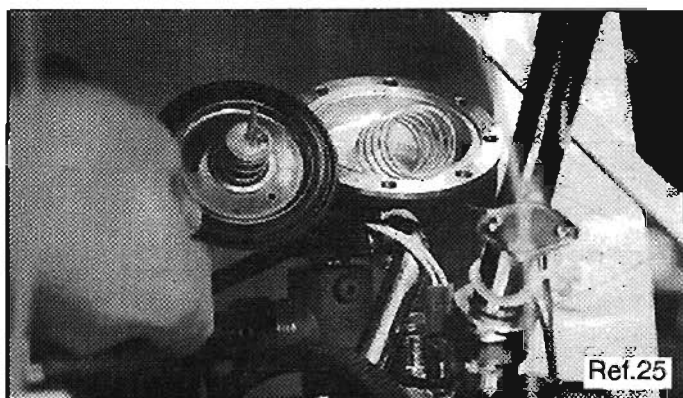

### Ref.28

Measure first that supply voltage is supplied to the pump.

Set the tester to VAC.

Then measure the resistance of the windings of the pump it must be not lower than 190  $\Omega$  and not infinity.

Set tester to Ohm.

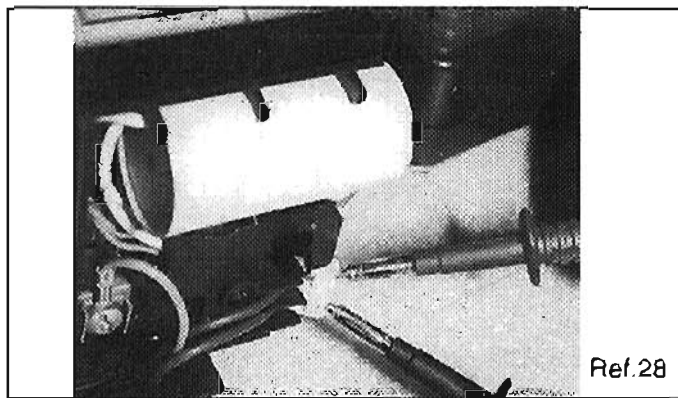

### Ref.26

Verify that the electric bridges of the clock and/or room thermostat are installed (when clock and/or room thermostat are not connected).

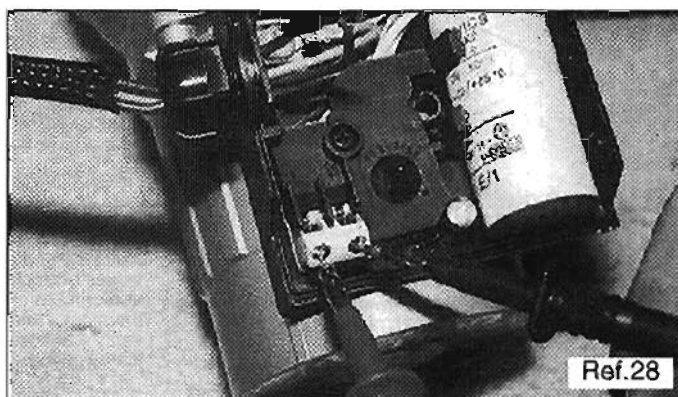
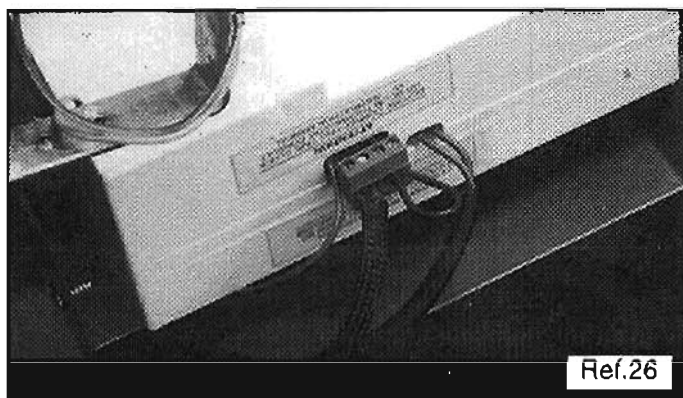

### Ref.29

Disconnect the terminals of the flow switch and make measurements of the resistance that must be zero.

Set tester to Ohm.



# Fault finding

## 7.5 FAULT FINDING WITHOUT THE UTILIZATION OF THE TOTAL CHECK SYSTEM

The utilization of TCS is the more efficient way to single out a defect, because its message let only a restricted area to be checked.

But in the case of TCS not availability, it is possible to detect and remove the eventual defect utilizing the standard fault finding diagrams described in this chapter.

The checking modes referred to are the same as with utilization of TCS.

### 7.5.1 APPLIANCE COMPLETELY SHUT DOWN

INITIAL CONDITIONS:

- The main switch is on position "ON" (neon light);
- The boiler is switched on "WINTER" position.

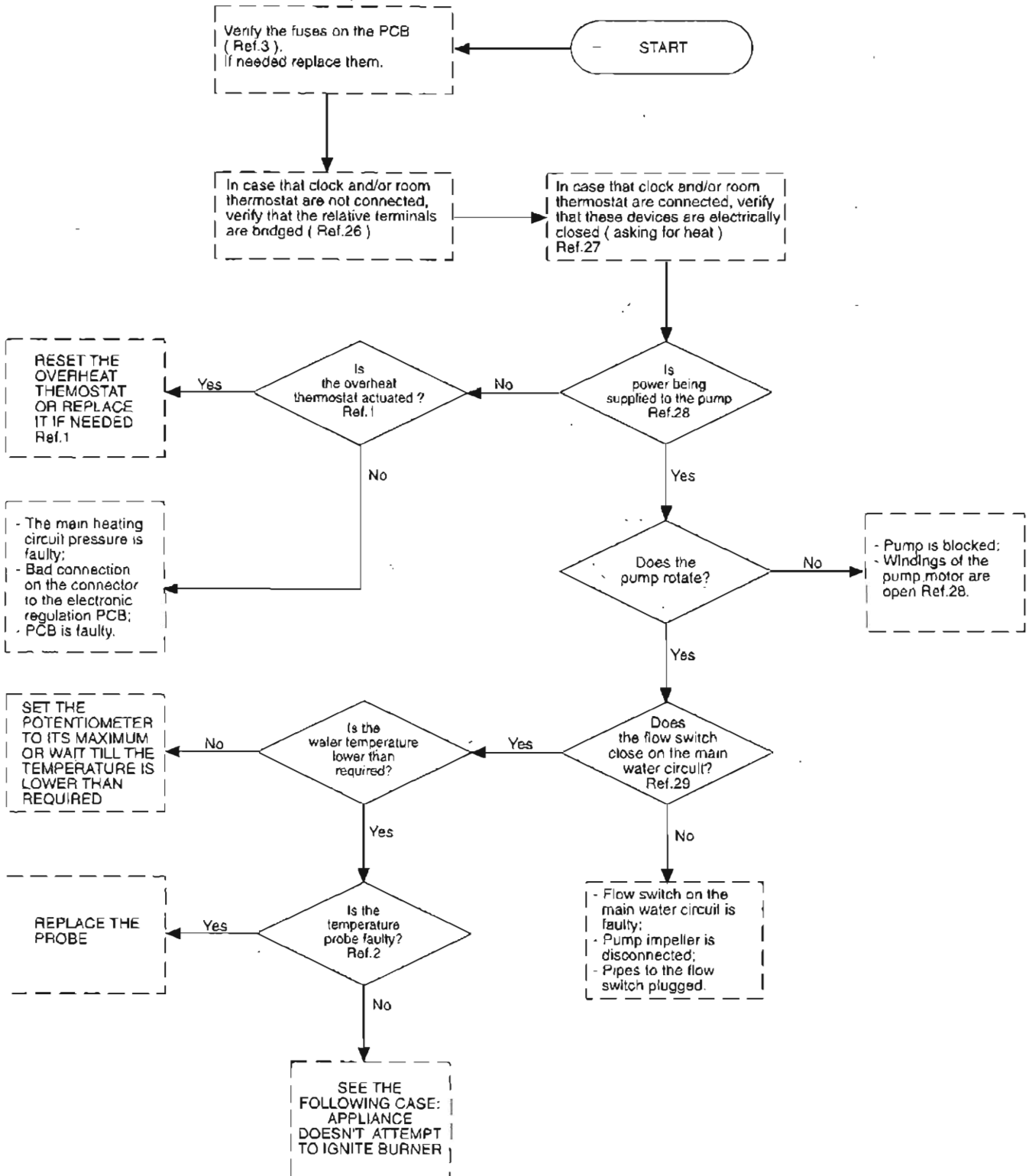

# Fault finding

## 7.5.2 APPLIANCE DOESN'T ATTEMPT TO IGNITE THE BURNER ( NO SPARKS )

INITIAL CONDITIONS:

- The main switch is on position "ON" (neon light);
- The boiler is switched on "WINTER" position;
- All preliminary verifications according to 7.5.1 have been done without succes.

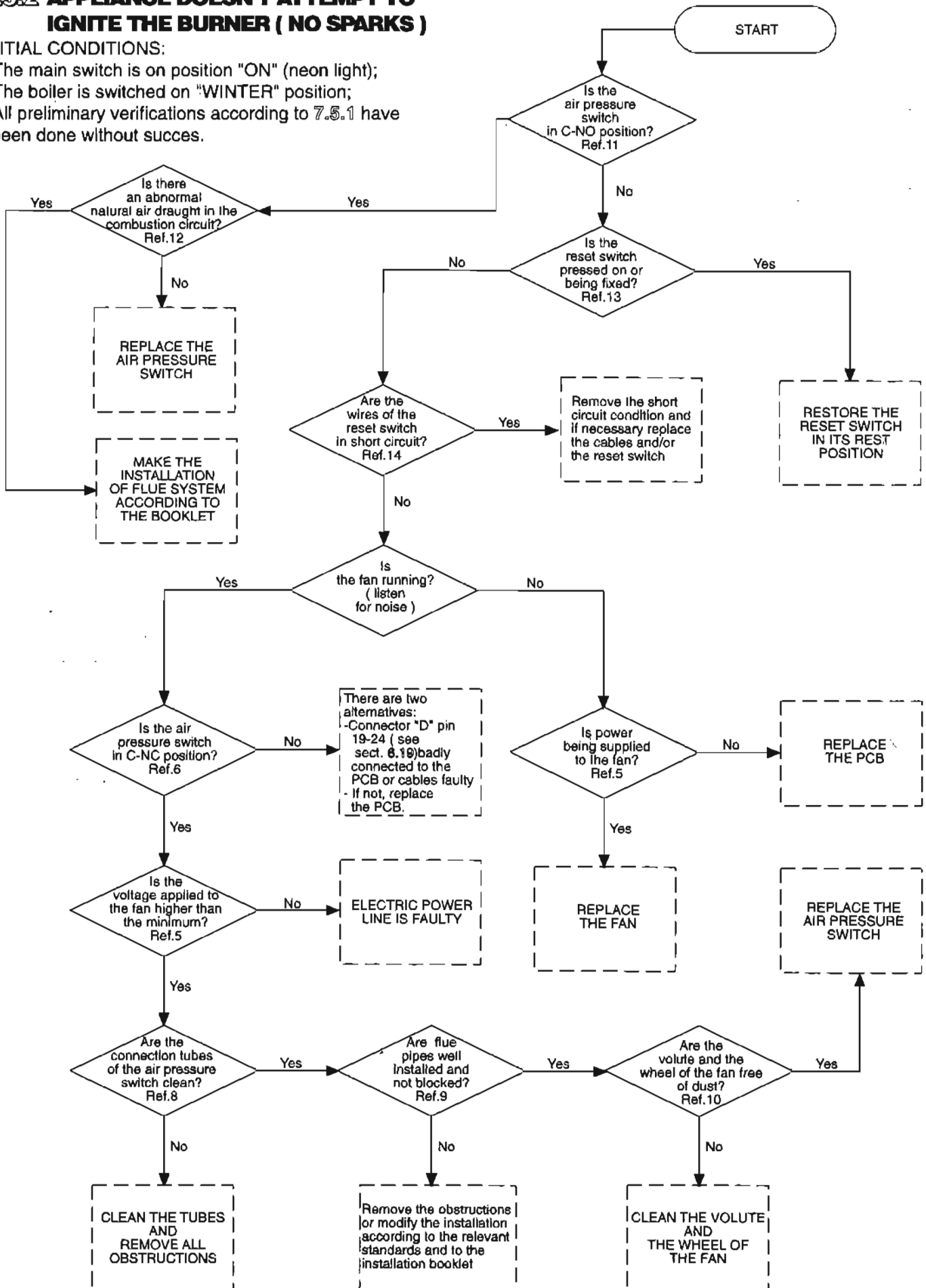

# Fault finding

## 7.5.3 APPLIANCE FAIL FREQUENTLY IGNITION WITH CONSEQUENT LOCKOUT ( RED LIGHT ON THE RESET PUSH BUTTON )

### INITIAL CONDITIONS:

- The main switch is on position "ON" (neon light);
- The boiler is switched on "WINTER" or "SUMMER" position;
- Space heat or hot water are expected.

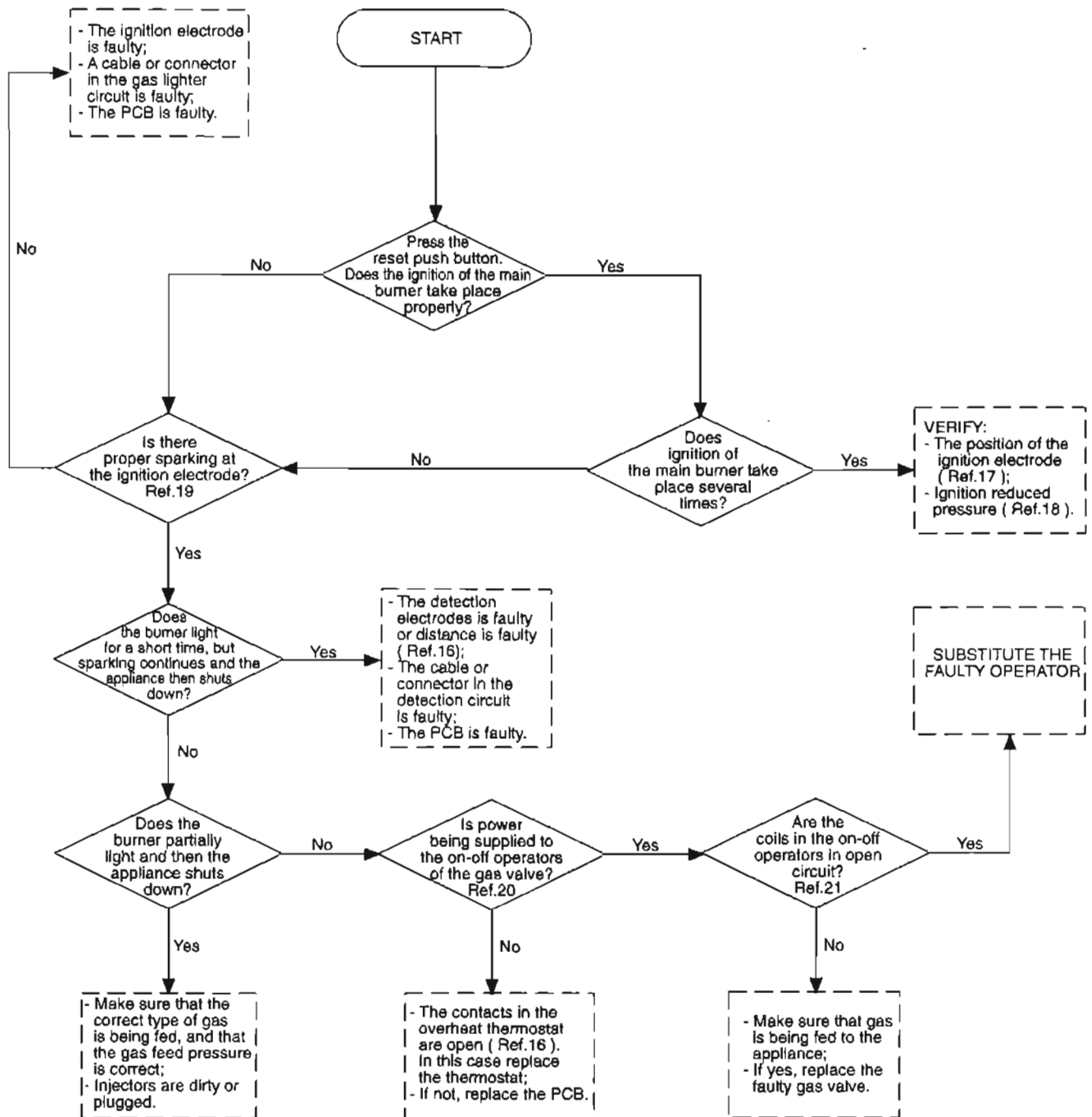

# Fault finding

## 7.5.4 FAULT ON "HOT WATER - SPACE HEATING" SWITCHING

INITIAL CONDITIONS:

- The main switch is on position "ON" (neon light);
- The boiler is switched on "WINTER" position;

**CASE A** : The appliance operates in the central heating mode only and not in hot water mode.

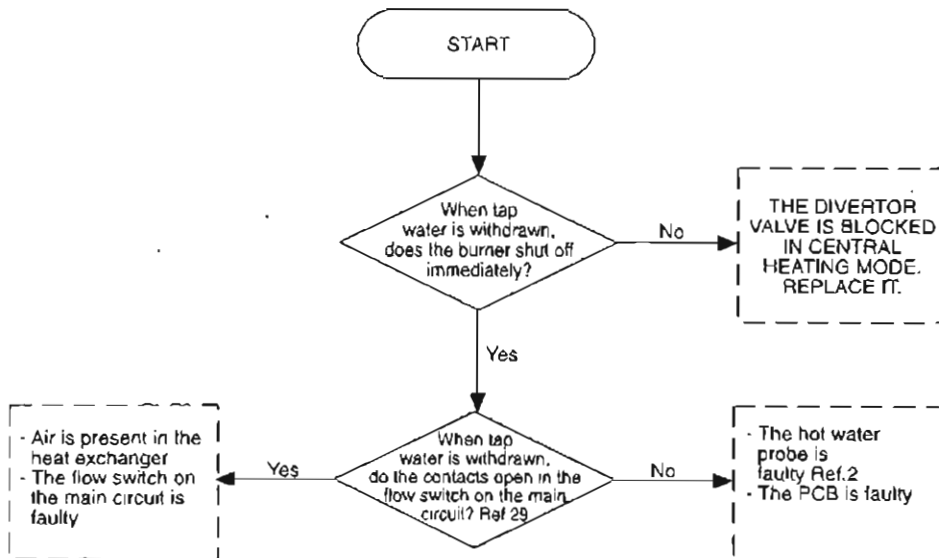

**CASE B** : The appliance operates in the hot water mode only and not in central heating mode.

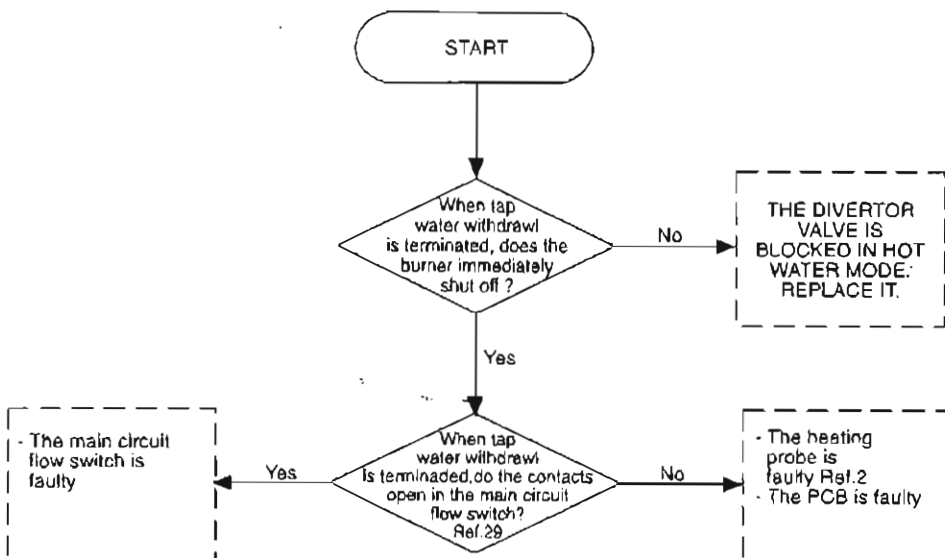

# 8 ELECTRIC DIAGRAMS

## 8.1 ELECTRICAL CONNECTION

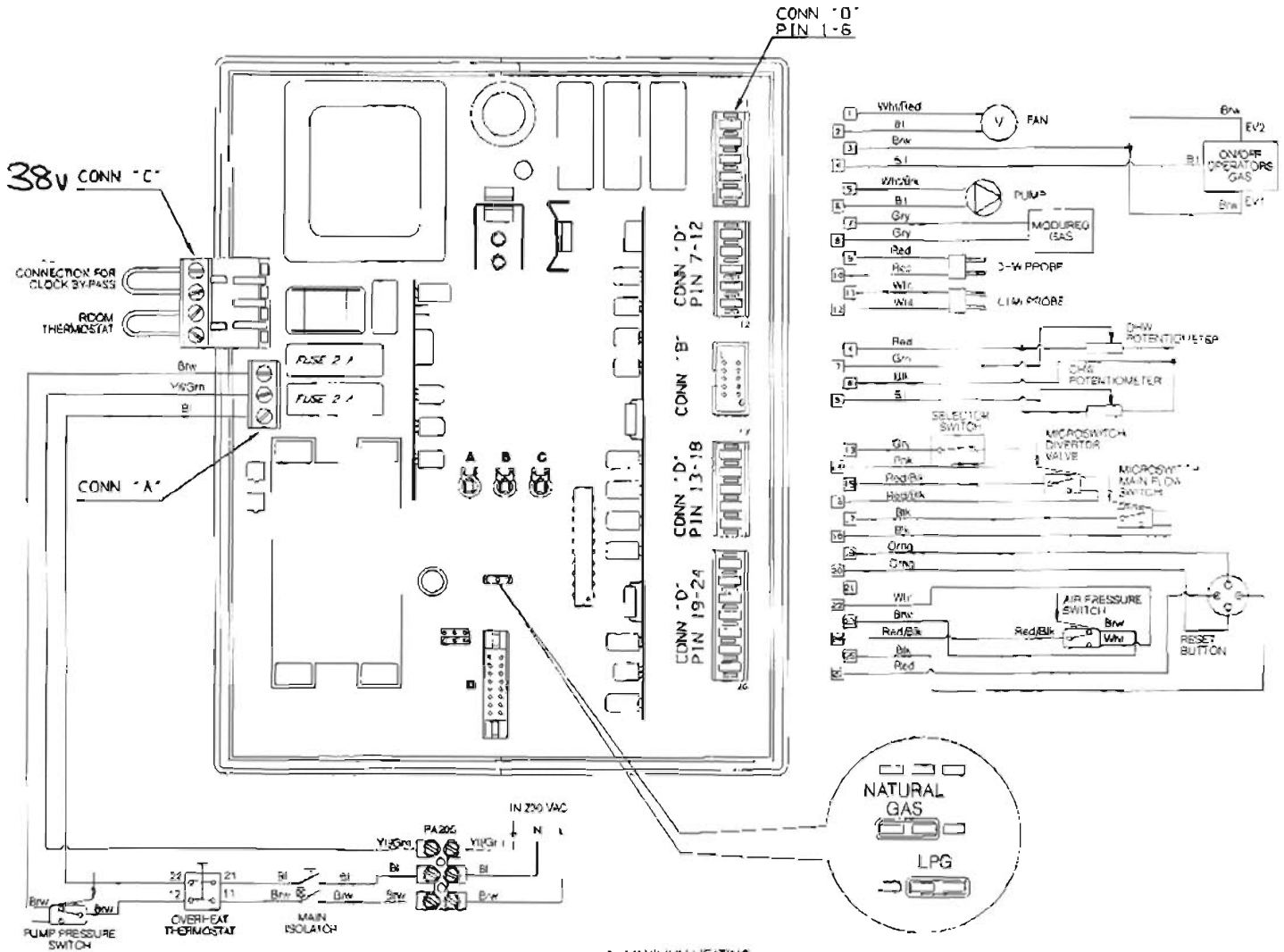

### COLOUR

- Bl =Blue
- Red =Red
- Brw =Brown
- Blk =Black
- Gry =Grey
- Vio =Violet
- Whl =White
- Pnk =Pink
- Grn =Green
- Orng =Orange
- Yl/Gm =Yellow/Green
- Whl/Blk =White/Black
- Whl/Red =White/Red
- Red/Blk =Red/Black

- A MAXIMUM HEATING CIRCUIT POWER
- B DELAY OF THE IGNITION OF THE HEATING CONTROL
- C SLOW IGNITION OF THE BOILER
- D TCS CONNECTOR

# Electric diagrams

## 8.2 FUNCTIONAL FLOW CONNECTION

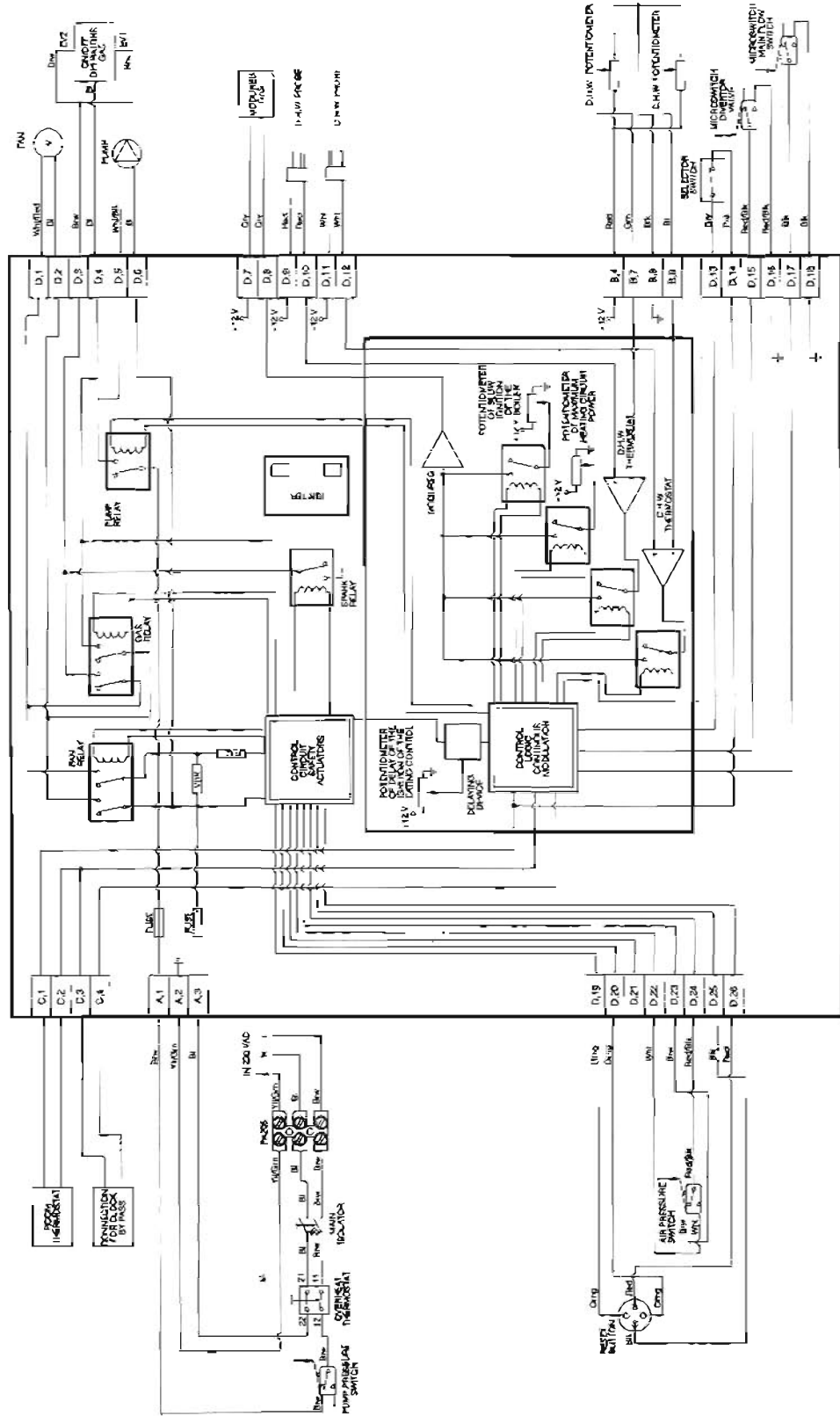

COLOUR	
Bl	= Blue
Red	= Red
Brw	= Brown
Blk	= Black
Gry	= Grey
Vio	= Violet
Whi	= White
Pnk	= Pink
Gm	= Green
Omg	= Orange
Yll/Grn	= Yellow/Green
Whi/Blk	= White/Black
Whi/Red	= White/Red
Red/Blk	= Red/Black





# Short spare parts list

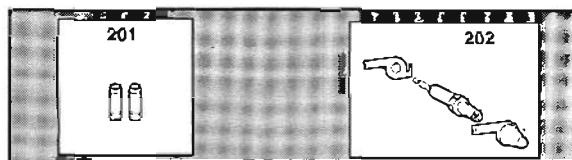
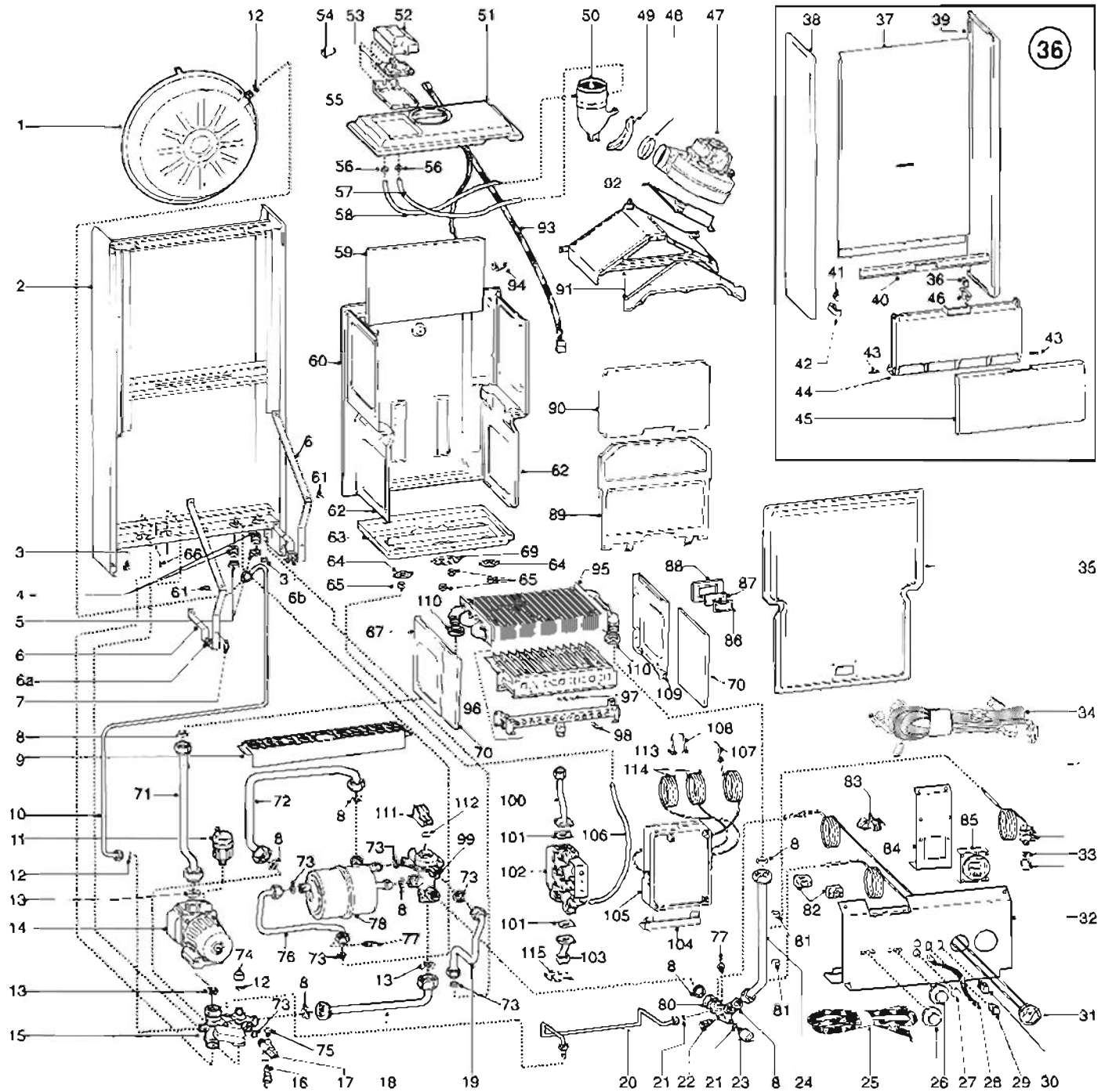



## CONTROL PANEL

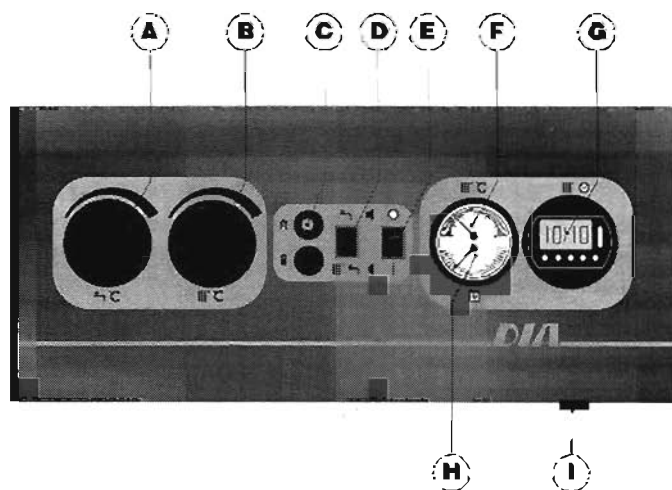

- A : Domestic hot water temperature control
- B : Central heating temperature control
- C : Red warning light
- D : Summer/winter switch
- E : On/off switch with neon light
- F : Central heating flow temperature gauge
- G : Central heating time control clock
- H : Water pressure gauge
- I : Safety thermostat reset

### RESIDUAL HEAD OF THE CIRCULATOR

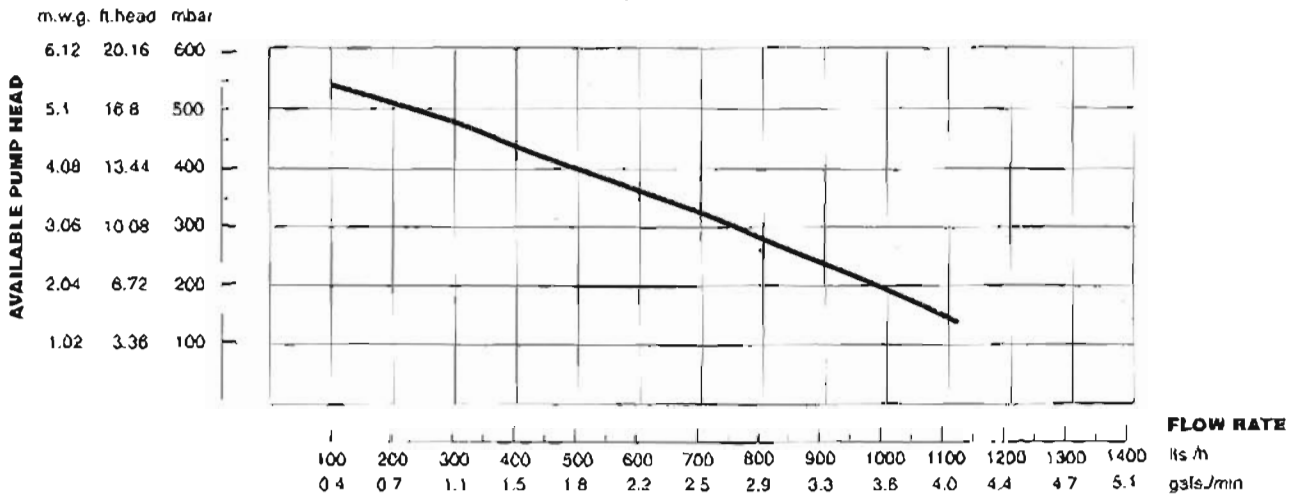

### REGULATING HEATING POWER FOR NATURAL GAS (G20)

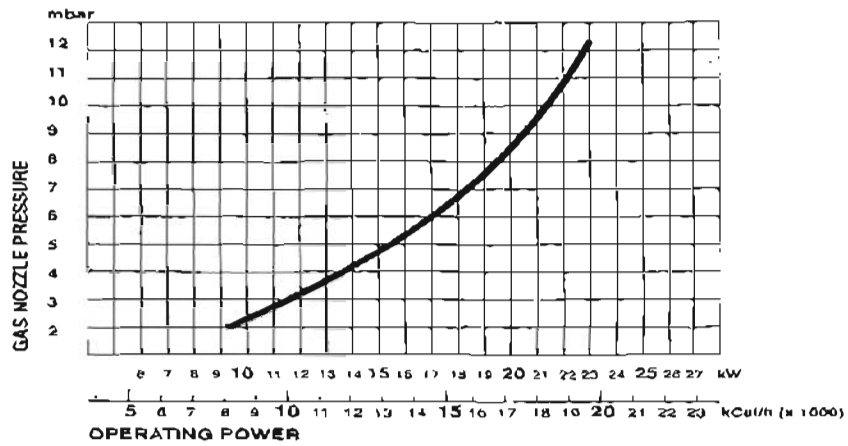

### REGULATING HEATING POWER FOR BUTANE GAS (G30)

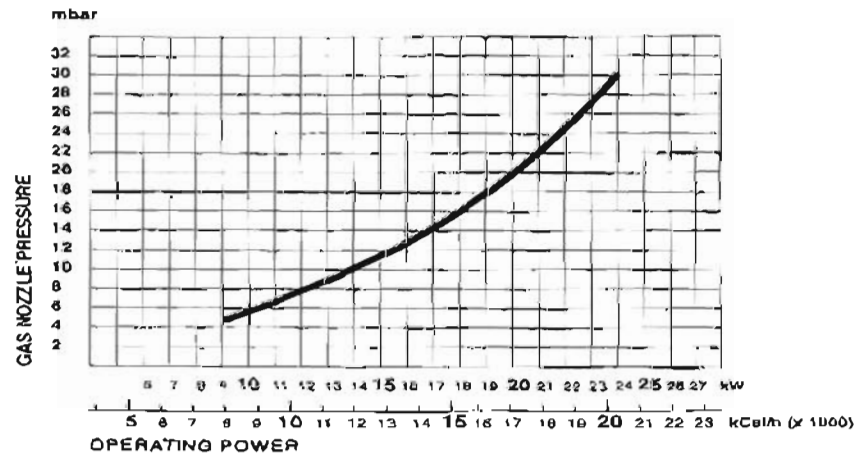

### REGULATING HEATING POWER FOR PROPANE GAS (G31)

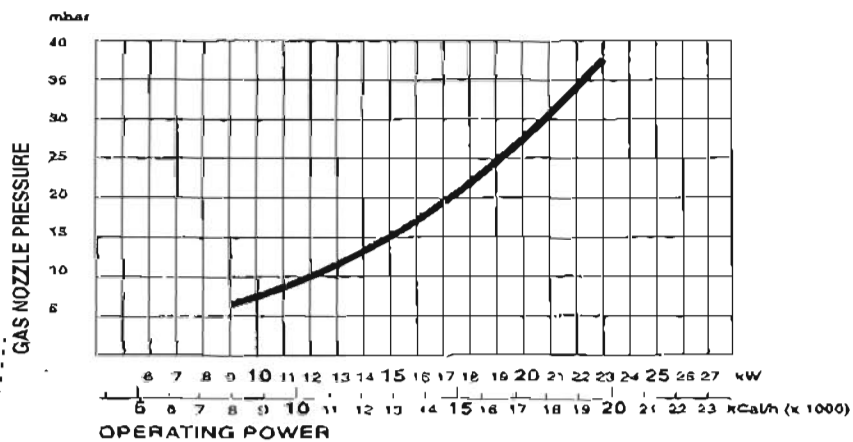

Manufacturer: Merloni TermoSanitari S.p.A. - Italy

Importer : MTS (GB) LIMITED  
MTS Building, Hughenden Avenue, High Wycombe  
Bucks HP 13 5FT  
Telephone (0494) 459711 - Fax (0494) 459775





## SPARE PARTS EXPLODED VIEW WALL-HUNG GAS BOILERS

Models

**DIA 20 MFFI CE**

**DIA 24 MFFI CE**

---

Edition 2



MODELS	CODE	SERIAL NO. VALIDITY	REF.
DIA 20 MFFI CE	533632	From 96010000 to -----	A
DIA 20 MFFI CE LPG	533633	From 96010000 to -----	B
DIA 24 MFFI CE	534028	From 96010000 to -----	C
DIA 24 MFFI CE LPG	534029	From 96010000 to -----	D

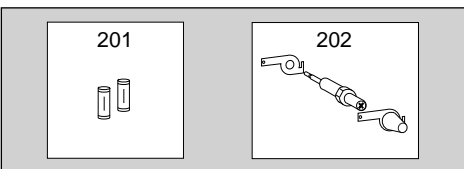
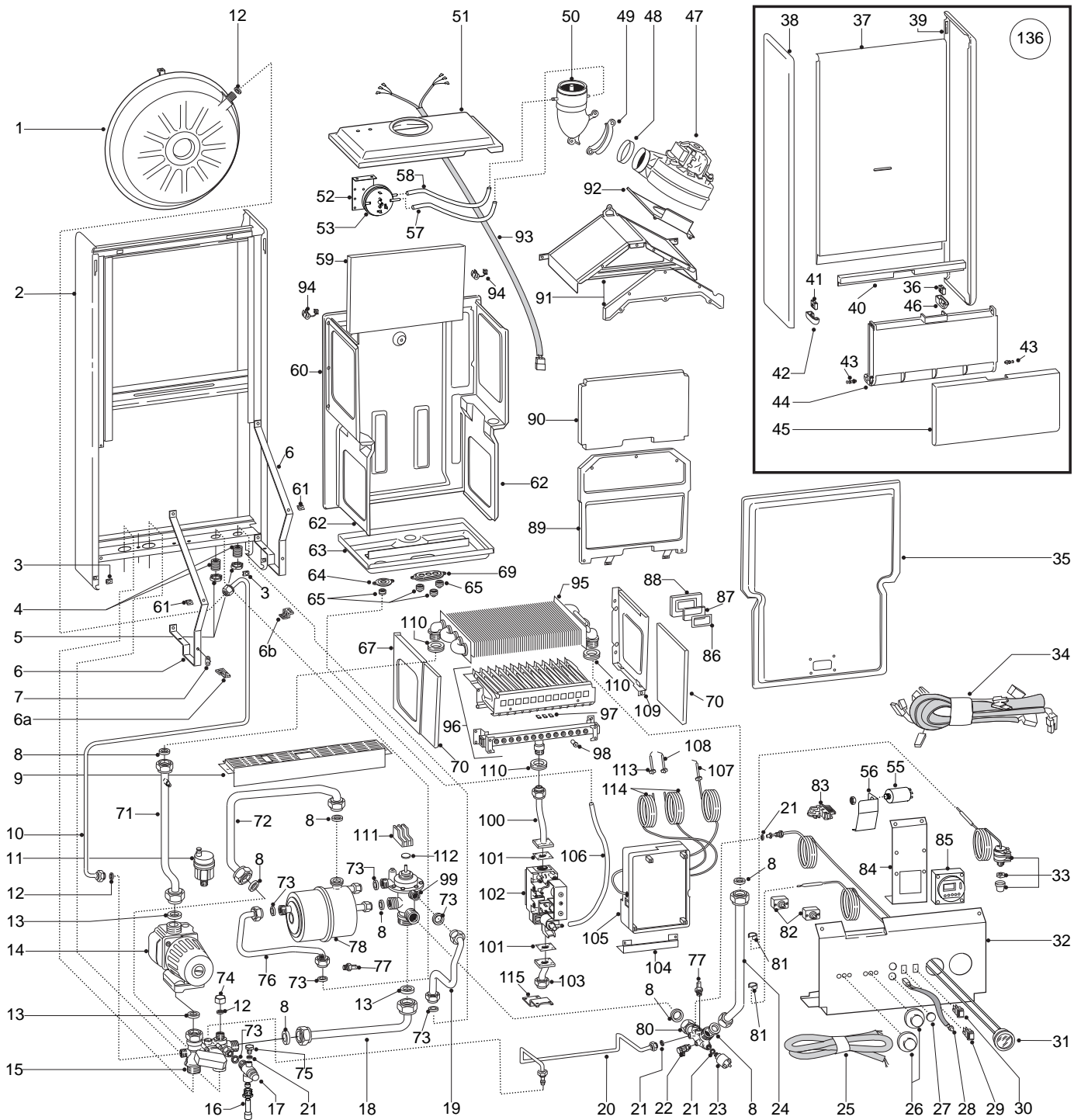

PART	CODE	DESCRIPTION	REF.	NOTE
1	564492	Expansion vessel		
2	570805	Boiler frame		
3	565128	Fastening spring		
4	573531	Brass nipple 1/2"		
5	573530	Securing nut 1/2"		
6	571963	Holder for control panel		
6a	569192	Left hand side hinge		
6b	566093	Right hand side hinge		
7	569604	Earth symbol		
8	573520	Gasket 3/4"		
9	572381	Grill		
10	570575	Pipe (expansion vessel)		
11	564254	Automatic air release valve		
12	573521	Gasket 3/8"		
13	569387	Gasket 1"		
14	570590	Pump	AB	
14	570931	Pump	CD	
15	570533	C.H. flow return group		
16	570932	Drainage pipe		
17	569292	Safety valve		
18	570454	Pipe (C.H. flow)		
19	570751	Pipe (D.H.W. inlet)		
20	571119	Pipe (upper main flow switch)		
21	569390	Gasket 1/4"		
22	573727	Drain cock		
23	570605	Pump pressure switch		
24	570449	Pipe (C.H.W.)	AB	
24	570450	Pipe (C.H.W.)	CD	
25	570593	Main power supply cord		
26	569421	Control knob		
27	569422	Plastic plug		
28	560171	Wired reset button		
29	569423	Summer/winter switch		
30	569424	On/off switch with neon		
31	571832	Temperature pressure gauge		
32	571672	Control panel		
33	571829	Overheat thermostat		
34	571696	Wiring loom		
35	569605	Sealed chamber front panel	AB	
35	569606	Sealed chamber front panel	CD	
36	569474	Female insert R.H. hinge		
37	569657	Frontal casing panel		
38	569656	L.H. casing panel		
39	569655	R.H. casing panel		
40	569476	Plastic insert		
41	569475	Female insert for L.H. hinge		
42	569473	Female insert housing L.H. hinge		
43	569470	Hinge pivot		
44	569471	Case door insert		
45	569469	Case door		
46	569472	Female insert housing R.H. hinge		
47	569431	Fan	AB	
47	573434	Fan	CD	
48	569433	Fan seal		
49	569434	Collar for venturi device		
50	572382	Venturi device		
51	571844	Sealed chamber cover	AB	
51	571845	Sealed chamber cover	CD	
52	571635	Air pressure switch bracket		
53	571651	Air pressure switch	AB	
53	571652	Air pressure switch	CD	
55	572660	Radio suppressor		

<b>PART</b>	<b>CODE</b>	<b>DESCRIPTION</b>	<b>REF.</b>	<b>NOTE</b>
56	571790	Radio suppressor bracket		
57	571574	Silicone pipe - negative signal		
59	573723	Back insulation panel	AB	
59	573724	Back insulation panel	CD	
60	571791	Sealed chamber back support	AB	
60	571792	Sealed chamber back support	CD	
61	569201	Spring clip		
62	569454	Sealed chamber side panel		
63	571611	Sealed chamber lower cover	AB	
63	571789	Sealed chamber lower cover	CD	
64	569457	Inspection plate (detection election)		
65	569458	Cable holders		
67	570474	Panel (combustion chamber L.H.)		
69	571612	Inspection plate (three hole)		
70	573720	Side insulation panel		
71	570719	Pipe (pump - to main exchanger)		
72	570453	Pipe (sec. exchanger to C.H. return group)		
73	573528	Gasket 1/2"		
74	570491	Plug female 3/8"		
75	569259	Plug male 1/4"		
76	570640	Pipe (D.H.W.)		
77	569236	Temp probe		
78	566098	Secondary exchanger		
79	570788	Plastic cap		
80	570565	Multifunctional hydraulic connector		
81	571565	Phial clip		
82	691150	Potentiometer		
83	569391	Main power supply cord clamp		
84	570933	Time clock support		
85	569538	Time clock (digital)		
86	569442	View window seal		
87	573567	View window glass		
88	573566	View window holder		
89	572647	Panel (combustion chamber front)	AB	
89	572648	Panel (combustion chamber front)	CD	
90	573721	Front insulation panel	AB	
90	573722	Front insulation panel	CD	
91	570518	Flue hood	AB	
91	570519	Flue hood	CD	
92	569429	Fan support plate	AB	
92	573048	Fan support plate	CD	
93	572168	Fan supply cord		
94	570561	Fan power supply cord clamp		
95	569487	Main exchanger	AB	
95	569562	Main exchanger	CD	
96	572271	Burner (natural gas)	A	
96	572343	Burner (natural gas)	C	
96	572272	Burner (LPG)	B	
96	572344	Burner (LPG)	D	
97	570608	Spring clips for electrodes		
98	570248	Burner jet (1.25mm)	A	
98	570251	Burner jet (0.72mm)	B	
99	560166	Divertor valve		
100	572698	Pipe (gas valve to burner)		
101	569254	Gas valve gasket		
102	570732	Gas valve (sit tandem)		
103	570750	Pipe (gas inlet)		
104	569462	Lower P.C.B. support		
105	950331	P.C.B.		
106	573576	Compensation tube		
107	573441	Detection electrode		

PART	CODE	DESCRIPTION	REF.	NOTE
108	569560	Ignition electrode (R.H.)		
109	570473	Panel (combustion chamber R.H.)		
110	569443	Silicone seal		
111	569172	Micro switch (single)		
112	569451	Pushing cap		
113	569561	Ignition electrode (L.H.)		
114	569503	Cable (ignition electrode)		
115	570446	Gas valve support		
116	570712	Sit tandem operator coils		
117	569281	Burner jet (1.25mm) full kit	AC	
117	569282	Burner jet (0.72mm) full kit	BD	
118	571409	Bolts and expansion caps full kit		
119	570741	Wall hanging bracket		
122	570809	Paper wall template		
123	571000	Valve kit: gas cock		
124	570813	Valve kit: D.H.W. outlet pipe		
125	570812	Valve kit: D.W. inlet pipe		
126	570743	Valve kit: D.W. inlet cock		
127	570818	Valve kit: gas inlet pipe		
129	570817	Valve kit: C.H. flow-return pipe		
131	573740	Sit tandem modureg coil		
136	570738	Full case assembled		
201	950030	Fast fuse 2AT		
202	573745	Gas modular cartridge		
371	570714	Service kit (main flow switch)		
372	570713	Micro switch (main flow switch)		
373	573824	Retaining clip (main flow switch)		

PART. NOTIFICATION OF CHANGES				
Spares listed below are not interchangeable with those in Ed.1				
20	571119 - Pipe (main flow switch - upper)	- replaces code 570664 from serial number: 96010000		
34	571696 - Wiring loom	- replaces code 570748 from serial number: 96010000		
51	571844 - Cover (combustion chamber - DIA 20)	- replaces code 570550 from serial number: 96010000		
51	571845 - Cover (combustion chamber - DIA 24)	- replaces code 997224 from serial number: 96010000		
53	571651 - Air pressure switch (DIA 20)	- replaces code 570549 from serial number: 96010000		
53	571652 - Air pressure switch (DIA 24)	- replaces code 573452 from serial number: 96010000		
55	572660 - Radio suppressor	- not listed on original drawing		
56	571790 - Bracket (radio suppressor)	- not listed on original drawing		
57	571574 - Tube (air pressure switch - negative)	- replaces code 569863 from serial number: 96010000		
60	571791 - Support (sealed chamber - rear - DIA 20)	- replaces code 570612 from serial number: 96010000		
60	571792 - Support (sealed chamber - rear - DIA 24)	- replaces code 571264 from serial number: 96010000		
63	571611 - Lower cover (sealed chamber - DIA 20)	- replaces code 570551 from serial number: 96010000		
63	571789 - Lower cover (sealed chamber - DIA 24)	- replaces code 570552 from serial number: 96010000		
69	571612 - Inspection plate	- replaces code 569459 from serial number: 96010000		
72	570453 - Pipe (sec. exchanger - CH return group)	- replaces code 571565 from serial number: 96010000		
81	571565 - Phial clip	- replaces code 570543 from serial number: 96010000		
93	572168 - Fan supply cable	- replaces code 570591 from serial number: 96010000		