

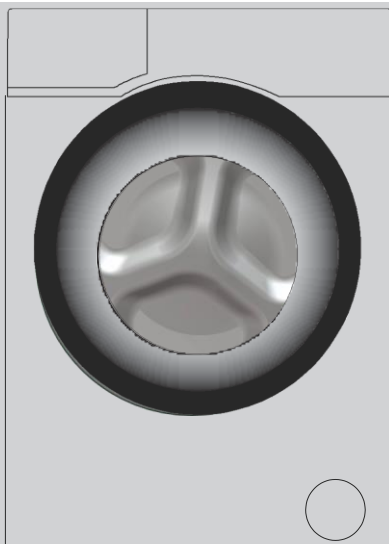

SAWS 8160

Lavatrice
Manuale utente
Washing Machine
User's Manual



Please read this user manual first!

Dear Customer,

Thank you for preferring a Smeg product. We hope that you get the best results from your product which has been manufactured with high quality and state-of-the-art technology. Therefore, please read this entire user manual and all other accompanying documents carefully before using the product and keep it as a reference for future use. If you handover the product to someone else, give the user manual as well. Follow all warnings and information in the user manual.

Remember that this user manual is also applicable for several other models. Differences between models will be identified in the manual.

Explanation of symbols

Throughout this user manual the following symbols are used:

	Important information or useful hints about usage.
--	--

	Warning for hazardous situations with regard to life and property.
--	--

	Warning for electric shock.
--	-----------------------------

	Packaging materials of the product are manufactured from recyclable materials in accordance with our National Environment Regulations.
--	--

Do not dispose of the packaging materials together with the domestic or other wastes. Take them to the packaging material collection points designated by the local authorities.

TABLE OF CONTENTS

1 Important instructions for safety and environment	4	5 Operating the product	21
1.1 General safety	4	5.1 Control panel	21
1.2 Intended use	5	5.2 Display symbols	22
1.3 Children's safety.	6	5.3 Preparing the machine	23
1.4 Package information.	6	5.4 Programme selection	23
1.5 Disposing of the waste product	6	5.5 Programmes	23
1.6 Compliance with WEEE Directive	7	5.8 Temperature selection.	27
2 Your washing machine	8	5.9 Spin speed selection.	27
2.1 Overview	8	5.10 Programme and consumption table.	29
2.2 Package Contents	9	5.11 Auxiliary function selection	30
2.3 Technical specifications	10	5.12 End Time	31
3 Installation	11	5.13 Starting the programme	31
3.1 Appropriate installation location.	11	5.14 Loading door lock.	32
3.2 Removing packaging reinforcement	11	5.15 Changing the selections after the programme has started	32
3.3 Removing the transportation locks.	11	5.16 Child Lock	32
3.4 Connecting water supply.	12	5.17 Canceling the programme.	33
3.5 Connecting to the drain.	13	5.18 End of programme	33
3.6 Adjusting the feet	13	5.19 Adjusting the VOLUME level	33
3.7 Electrical connection.	14	6 Maintenance and cleaning	34
4 Preparation	15	6.1 Cleaning the detergent drawer	34
4.1 Sorting the laundry	15	6.2 Cleaning the loading door and the drum	34
4.2 Preparing laundry for washing.	16	6.3 Cleaning the body and control panel	35
4.3 Things to be done for energy saving	16	6.4 Cleaning the water intake filters	35
4.4 Initial use	17	6.5 Draining remaining water and cleaning the pump filter.	35
4.5 Correct load capacity	17	7 Troubleshooting	37
4.6 Loading the laundry	17		
4.7 Using detergent and softener	17		
4.8 Tips for efficient washing	20		

Important instructions for safety and environment

This section contains safety instructions that will help protect from risk of personal injury or property damage. Failure to follow these instructions shall void any warranty.

1.1 General safety

- This product can be used by children at and above 8 years old and by persons whose physical, sensory or mental capabilities were not fully developed or who lack experience and knowledge provided that they are supervised or trained on the safe usage of the product and the risks it brings out. Children must not play with the product. Cleaning and maintenance works should not be performed by children unless they are supervised by someone. Children of less than 3 years should be kept away unless continuously supervised.
- Never place the product on a carpet-covered floor. Otherwise, lack of airflow beneath the machine will cause electrical parts to overheat. This will cause problems with your product.
- If the product has a failure, it should not be operated unless it is repaired by the Authorized Service Agent. There is the risk of electric shock!
- This product is designed to resume operating in the event of powering on after a power interruption. If you wish to cancel the programme, see "Cancelling the programme" section.
- Connect the product to a grounded outlet protected by a 16 A fuse. Do not neglect to have the grounding installation made by a qualified electrician. Our company shall not be liable for any damages that will arise when the product is used without grounding in accordance with the local regulations.
- The water supply and draining hoses must be securely fastened and remain undamaged. Otherwise, there is the risk of water leakage.
- Never open the loading door or remove the filter while there is still water in the drum. Otherwise, risk of flooding and injury from hot water will occur.
- Do not force open the locked loading door. The loading door will be ready to open just a few minutes after the washing cycle comes to an end. In case of forcing the loading door to open, the door and the lock mechanism may get damaged.
- Unplug the product when not in use.

- Never wash the product by spreading or pouring water onto it! There is the risk of electric shock!

- Never touch the plug with wet hands! Never unplug by pulling on the cable, always pull out by grabbing the plug.
- Use detergents, softeners and supplements suitable for automatic washing machines only.
- Follow the instructions on the textile tags and on the detergent package.
- The product must be unplugged during installation, maintenance, cleaning and repairing procedures.
- Always have the installation and repairing procedures carried out by the **Authorized Service Agent**. Manufacturer shall not be held liable for damages that may arise from procedures carried out by unauthorized persons.
- If the supply cord is damaged, it must be replaced by the manufacturer, its service agent or similarly qualified persons in order to avoid a hazard.
- If the power cable is damaged, it must be replaced by the manufacturer, after sales service or a similarly qualified person (preferably an electrician) or someone designated by the importer in order to avoid possible risks.
- Place the product on a rigid, flat and level surface.
- Do not place it on a long-pile rug or similar surfaces.
- Do not place the product on a high platform or near the edge on a cascaded surface.
- Do not place the product on the power cable.
- Never use sponge or scrub materials. These will damage the painted, chrome plated and plastic surfaces.

1.2 Intended use

- This product has been designed for domestic use. It is not suitable for commercial use and it must not be used out of its intended use.
- The product must only be used for washing and rinsing of laundry that are marked accordingly.
- The manufacturer waives any responsibility arisen from incorrect usage or transportation.

Important instructions for safety and environment

1.3 Children's safety

- Packaging materials are dangerous to children. Keep packaging materials in a safe place away from reach of the children.
- Electrical products are dangerous for the children. Keep children away from the product when it is in use. Do not let them to tamper with the product. Use child lock to prevent children from intervening with the product.
- Do not forget to close the loading door when leaving the room where the product is located.
- Store all detergents and additives in a safe place away from the reach of the children by closing the cover of the detergent container or sealing the detergent package.



While washing the laundry at high temperatures, the loading door glass becomes hot. Therefore, keep especially the children away from the loading door of the machine while the washing operation is in progress.

1.4 Package information

- Packaging materials of the product are manufactured from recyclable materials in accordance with our National Environment Regulations. Do not dispose of the packaging materials together with the domestic or other wastes. Take them to the packaging material collection points designated by the local authorities.

1.5 Disposing of the waste product

- This product has been manufactured with high quality parts and materials which can be reused and are suitable for recycling. Therefore, do not dispose the product with normal domestic waste at the end of its service life. Take it to a collection point for the recycling of electrical and electronic equipment. Please consult your local authorities to learn the nearest collection point. Help protect the environment and natural resources by recycling used products. For

children's safety, cut the power cable and break the locking mechanism of the loading door so that it will be non-functional before disposing of the product.

1.6 Compliance with WEEE Directive

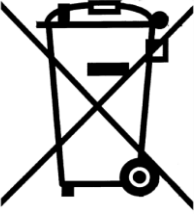

This product complies with EU WEEE Directive (2012/19/EU). This product bears a classification symbol for waste electrical and electronic equipment (WEEE).

This product has been manufactured with high quality parts and materials which can be reused and are suitable for recycling. Do not dispose of the waste product with normal domestic and other wastes at the end of its service life. Take it to the collection center for the recycling of electrical and electronic equipment. Please consult your local authorities to learn about these collection centers.

Compliance with RoHS Directive:

The product you have purchased complies with EU RoHS Directive (2011/65/EU). It does not contain harmful and prohibited materials specified in the Directive.

Your washing machine

2.1 Overview

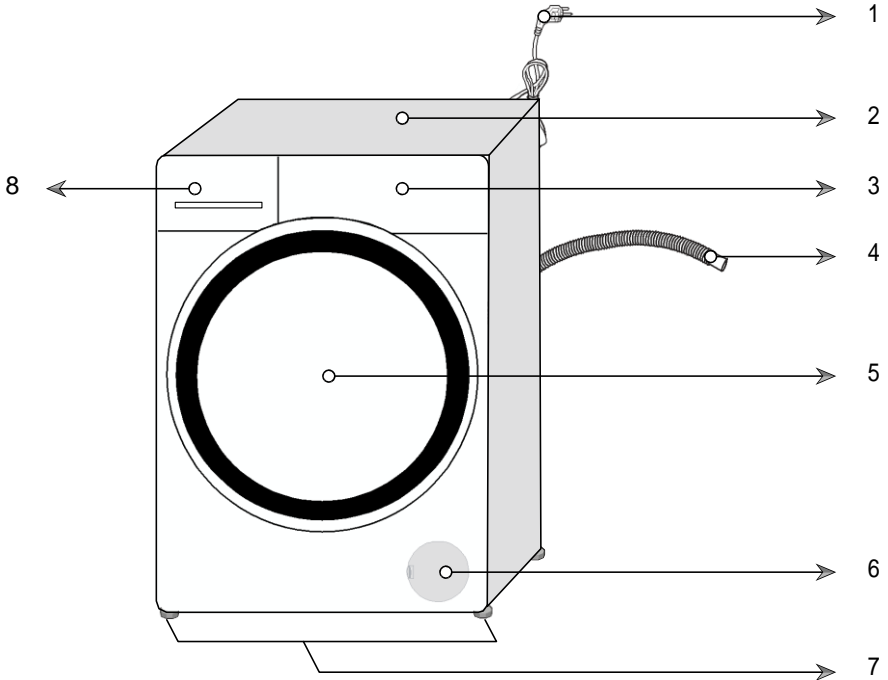

- 1- Power cable
- 2- Top panel
- 3- Control panel
- 4- Drain hose

- 5- Loading door
- 6- Filter cap
- 7- Adjustable feet
- 8- Detergent drawer

2.2 Package Contents

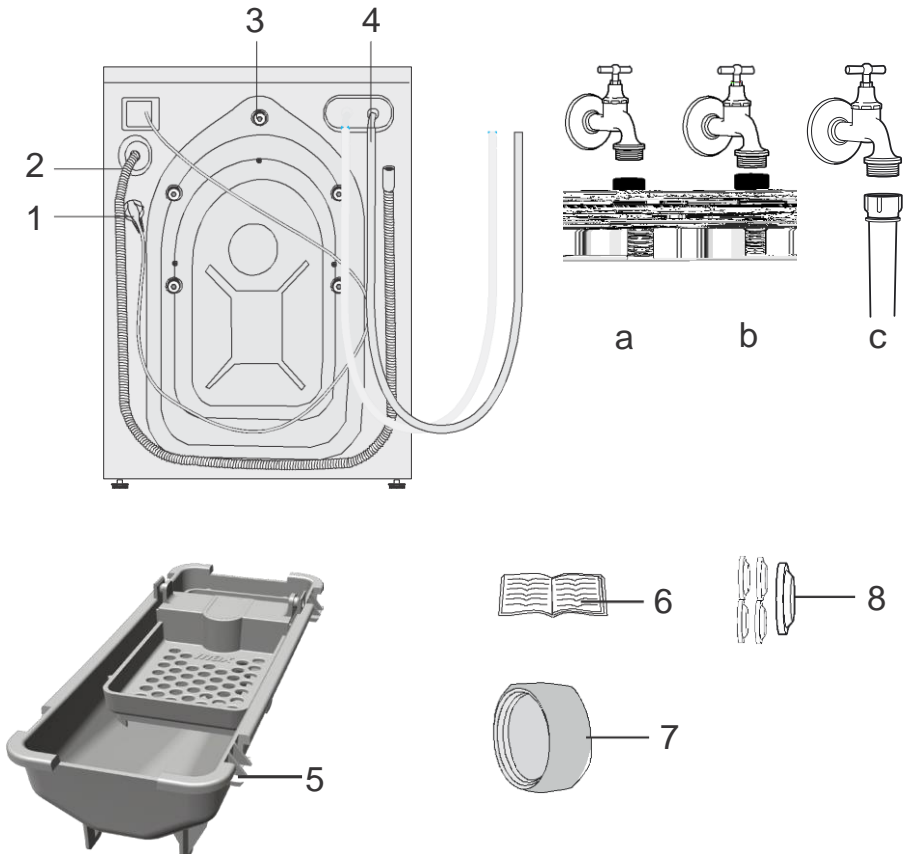

- 1- Power cable
- 2- Drain hose
- 3- Transportation safety bolts *
- 4- Mains water inlet hose (One of the following filter types is used for the mains hose connection.)
 - a- Electronic water shut-off
 - b- Mechanical water shut-off
 - c- Standard
- 5- Liquid detergent container**
- 6- User Manual
- 7- Blind plug***
- 8- Plastic plug assembly

* Number of transportation safety bolts may change depending on the model of your machine.

Your washing machine

- ** This may be supplied with the machine depending on the model of your machine.
- *** This is supplied if your machine is equipped with double water inlet.

2.3 Technical specifications

Models (EN)	SAWS 8160
Maximum dry laundry capacity (kg)	8
Height (cm)	84
Width (cm)	60
Depth (cm)	60
Net weight (± 4 kg.)	77
Electrical input (V/Hz)	220-240 V / 50Hz
Total current (A)	10
Total power (W)	2000-2350
Spin speed (rpm/ min., max.)	1600
Stand-by mode power (W)	0.64
Off-mode power (W)	0.44
Main model code	978
Single Water inlet / Double Water inlet	- / •
 Woolmark No:	M1403

• Available



“The wool wash cycle of this machine has been approved by The Woolmark Company for the washing of machine washable wool products provided that the products are washed according to the instructions on the garment label and those issued by the manufacturer of this washing machine. M1403.”
 “In UK, Eire, Hong Kong and India the Woolmark trade mark is a Certification trade mark.”

C

Technical specifications may be changed without prior notice to improve the quality of the product.

C

Figures in this manual are schematic and may not match the product exactly.

C

Values stated on the product labels or in the documentation accompanying it are obtained in laboratory conditions in accordance with the relevant standards. Depending on operational and environmental conditions of the product, these values may vary.

Installation

Refer to the nearest Authorised Service Agent for installation of the product. To make the product ready for use, review the information in the user manual and make sure that the electricity, tap water supply and water drainage systems are appropriate before calling the Authorized Service Agent. If they are not, call a qualified technician and plumber to have any necessary arrangements carried out.

C	Preparation of the location and electrical, tap water and waste water installations at the place of installation is under customer's responsibility.
B	WARNING: Installation and electrical connections of the product must be carried out by the Authorized Service Agent. Manufacturer shall not be held liable for damages that may arise from procedures carried out by unauthorized persons.
A	WARNING: Prior to installation, visually check if the product has any defects on it. If so, do not have it installed. Damaged products cause risks for your safety.
C	Make sure that the water inlet and discharge hoses as well as the power cable are not folded, pinched or crushed while pushing the product into its place after installation or cleaning procedures.

3.1 Appropriate installation location

- Place the machine on a rigid floor. Do not place it on a long pile rug or similar surfaces.
- Total weight of the washing machine and the dryer -with full load- when they are placed on top of each other reaches to approx. 180 kilograms. Place the product on a solid and flat floor that has sufficient load carrying capacity!
- Do not place the product on the power cable.
- Do not install the product at places where temperature may fall below 0°C.
- Place the product at least 1 cm away from the edges of other furniture.

3.2 Removing packaging reinforcement

Tilt the machine backwards to remove the packaging reinforcement. Remove the packaging reinforcement by pulling the ribbon.



3.3 Removing the transportation locks

A	WARNING: Do not remove the transportation locks before taking out the packaging reinforcement.
A	safety bolts before operating the washing machine. WARNING: Remove the transportation

1. Loosen all the bolts with a suitable spanner until they rotate freely (C).

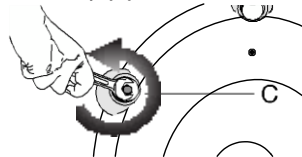

2. Remove transportation safety bolts by turning them gently.

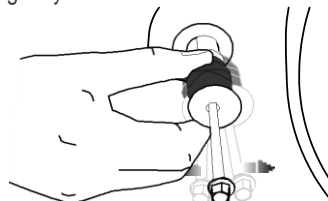

3. Attach the plastic covers supplied in the User Manual bag into the holes on the rear panel. (P)

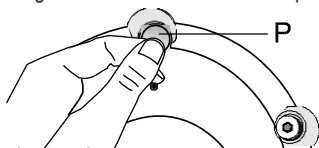

C Keep the transportation safety bolts in a safe place to reuse when the washing machine needs to be moved again in the future.

C Never move the product without the transportation safety bolts properly fixed in place!

3.4 Connecting water supply

C The water supply pressure required to run the product is between 1 to 10 bars (0.1 – 1 MPa). It is necessary to have 10 – 80 liters of water flowing from the fully open tap in one minute to have your machine run smoothly. Attach a pressure reducing valve if water pressure is higher.

C If you are going to use the double water-inlet product as a single (**cold**) water-inlet unit, you must install the supplied stopper to the hot water valve before operating the product. (Applies for the products supplied with a blind stopper group.)

A **WARNING:** Models with a single water inlet should not be connected to the hot water tap. In such a case the laundry will get damaged or the product will switch to protection mode and will not operate.

A **WARNING:** Do not use old or used water inlet hoses on the new product. It may cause stains on your laundry.

1. Connect the special hoses supplied with the product to the water inlets on the product. Red

hose (left) (max. 90 °C) is for hot water inlet, blue hose (right) (max. 25 °C) is for cold water inlet.

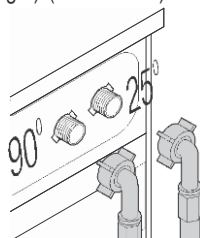

A **WARNING:** Ensure that the cold and hot water connections are made correctly when installing the product. Otherwise, your laundry will come out hot at the end of the washing process and wear out.

2. Tighten all hose nuts by hand. Never use a tool when tightening the nuts.



3. Open the taps completely after making the hose connection to check for water leaks at the connection points. If any leaks occur, turn off the tap and remove the nut. Retighten the nut carefully after checking the seal. To prevent water leakages and damages caused by them, keep the taps closed when the machine is not in use.

Installation

3.5 Connecting to the drain

- The end of the drain hose must be directly connected to the wastewater drain or to the washbasin.

A **WARNING:** Your house will be flooded if the hose comes out of its housing during water discharge. Moreover, there is risk of scalding due to high washing temperatures! To prevent such situations and to ensure smooth water intake and discharge of the machine, fix the end of the discharge hose tightly so that it cannot come out.

- The hose should be attached to a height of at least 60 cm, and 90 cm at most.
- In case the hose is elevated after laying it on the floor level or close to the ground (less than 60 cm above the ground), water discharge becomes more difficult and the laundry may come out excessively wet. Therefore, follow the heights described in the figure.

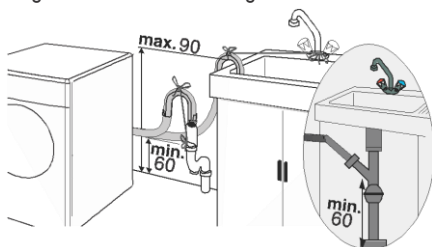

- To prevent flowing of dirty water back into the machine and to allow for easy discharge, do not immerse the hose end into the dirty water or do not drive it in the drain more than 15 cm. If it is too long, cut it short.
- The end of the hose should not be bent, it should not be stepped on and the hose must not be pinched between the drain and the machine.
- If the length of the hose is too short, use it by adding an original extension hose. Length of the hose may not be longer than 3.2 m. To avoid water leak failures, the connection between

the extension hose and the drain hose of the product must be fitted well with an appropriate clamp as not to come off and leak.

A

3.6 Adjusting the feet

WARNING: In order to ensure that the product operates more silently and vibration-free, it must stand level and balanced on its feet. Balance the machine by adjusting the feet. Otherwise, the product may move from its place and cause crushing and vibration problems.

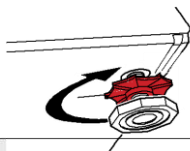

A

WARNING: Do not use any tools to loosen the lock nuts. Otherwise, they will get damaged.

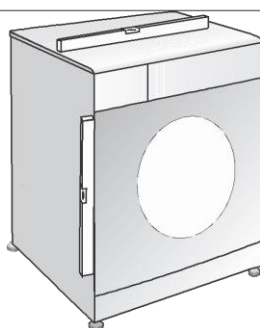

1. Loosen the lock nuts on the feet by hand.

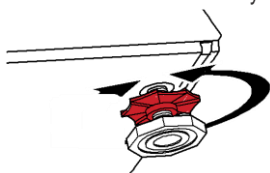

2. Adjust the feet until the product stands level and balanced.

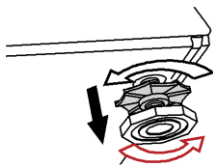

3. Tighten all lock nuts again by hand.



3.7 Electrical connection

Connect the product to a grounded outlet protected by a 16 A fuse. Our company shall not be liable for any damages that will arise when the product is used without grounding in accordance with the local regulations.

- Connection must comply with national regulations.
- Power cable plug must be within easy reach after installation.
- If the current value of the fuse or breaker in the house is less than 16 Amps, have a qualified electrician install a 16 Amp fuse.
- The voltage specified in the "Technical specifications" section must be equal to your mains voltage.
- Do not make connections via extension cables or multi-plugs.

B

WARNING: Damaged power cables must be replaced by the Authorized Service Agents.

Transportation of the product

1. Unplug the product before transporting it.
2. Remove water drain and water supply connections.
3. Drain all water that has remained in the product. See 6.5
4. Install transportation safety bolts in the reverse order of removal procedure; see 3.3.

C

Never move the product without the transportation safety bolts properly fixed in place!

A

WARNING: Packaging materials are dangerous to children. Keep packaging materials in a safe place away from reach of the children.

Preparation

4.1 Sorting the laundry

- Sort laundry according to type of fabric, colour, and degree of soiling and allowable water temperature.
- Always obey the instructions given on the garment tags.

		LAUNDRY WASH SYMBOLS								
WASH	Machine Wash Symbols									
	Water Temperatures	Maximum Symbol(s)	95°C 111 111	70°C 111 11	60°C 11 11	50°C 111	40°C 11	30°C 1		
DRYING	Drying Symbols									
	Drying Settings									
IRON	Iron - Dry or Steam		Iron at high temperature	Iron at medium temperature	Iron at low temperature					
	Maximum temperature		200 °C	150 °C	110 °C	Do not iron		Iron without steam		

Preparation

BLEACH	All bleaches are allowed	Bleach (sodium hypochlorite) can be used	Bleach is not allowed	Only bleaches without chlorine are allowed
--------	--------------------------	--	-----------------------	--

4.2 Preparing laundry for washing

- Laundry items with metal attachments such as, underwired bras, belt buckles or metal buttons will damage the machine. Remove the metal pieces or wash the clothes by putting them in a laundry bag or pillow case.
- Take out all substances in the pockets such as coins, pens and paper clips, and turn pockets inside out and brush. Such objects may damage the product or cause noise problem.
- Put small size clothes such as infant's socks and nylon stockings in a laundry bag or pillow case.
- Place curtains in without compressing them. Remove curtain attachment items.
- Fasten zippers, sew loose buttons and mend rips and tears.
- Wash "machine washable" or "hand washable" labeled products only with an appropriate programme.
- Do not wash colours and whites together. New, dark coloured cottons release a lot of dye. Wash them separately.
- Tough stains must be treated properly before washing. If unsure, check with a dry cleaner.
- Use only dyes/colour changers and limescale removers suitable for machine wash. Always follow the instructions on the package.
- Wash trousers and delicate laundry turned inside out.
- Keep laundry items made of Angora wool in the freezer for a few hours before washing. This will reduce pilling.
- Laundry that are subjected to materials such as flour, lime dust, milk powder, etc. intensely must be shaken off before placing into the machine. Such dusts and powders on the laundry may build up on the inner parts of the machine in time and can cause damage.

4.3 Things to be done for energy saving

Following information will help you use the product in an ecological and energy-efficient manner.

- Operate the product in the highest capacity allowed by the programme you have selected, but do not overload; see, "Programme and consumption table".
- Always follow the instructions on the detergent packaging.
- Wash slightly soiled laundry at low temperatures.
- Use faster programmes for small quantities of lightly soiled laundry.
- Do not use prewash and high temperatures for laundry that is not heavily soiled or stained.
- If you plan to dry your laundry in a dryer, select the highest spin speed recommended during washing process.
- Do not use detergent in excess of the amount recommended on the detergent package.

4.4 Initial use

Before starting to use the product, make sure that all preparations are made in accordance with the instructions in sections "Important safety instructions" and "Installation".

To prepare the product for washing laundry, perform first operation in Drum Cleaning programme. If your product is not equipped with Drum Cleaning programme, perform the Initial Use procedure in accordance with the methods described under "6.2 Cleaning the loading door and the drum" section of the user manual.

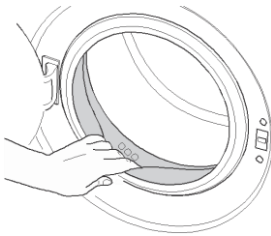

C Use an anti-limescale suitable for the washing machines.

Some water might have remained in the product due to the quality control processes in the production. It is not harmful for the product.

4.5 Correct load capacity

The maximum load capacity depends on the type of laundry, the degree of soiling and the washing programme desired.

The machine automatically adjusts the amount of water according to the weight of the loaded laundry.

A **WARNING:** Follow the information in the "Programme and consumption table". When overloaded, machine's washing performance will drop. Moreover, noise and vibration problems may occur.

4.6 Loading the laundry

1. Open the loading door.

C The loading door is locked while a programme is running. The door can only be opened a while after the programme comes to an end.

A **WARNING:** In case of misplacing the laundry, noise and vibration problems may occur in the machine.

4.7 Using detergent and softener

C When using detergent, softener, starch, fabric dye, bleach or limescale remover read the manufacturer's instructions on the package carefully and follow the suggested dosage values. Use measuring cup if available.

Detergent Drawer

The detergent drawer is composed of three compartments:

- (1) for prewash
- (2) for main wash
- (3) for softener
- (*) in addition, there is siphon piece in the softener compartment.

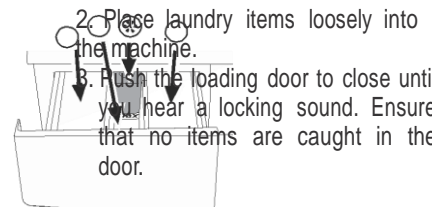

Preparation

2 3 1

Preparation

Detergent, softener and other cleaning agents

- Add detergent and softener before starting the washing programme.
- Never leave the detergent drawer open while the washing programme is running!
- When using a programme without prewash, do not put any detergent into the prewash compartment (compartment nr. "1").
- In a programme with prewash, do not put liquid detergent into the prewash compartment (compartment nr. "1").
- Do not select a programme with prewash if you are using a detergent bag or dispensing ball. Place the detergent bag or the dispensing ball directly among the laundry in the machine.
- If you are using liquid detergent, do not forget to place the liquid detergent cup into the main wash compartment (compartment nr. "2").

Choosing the detergent type

The type of detergent to be used depends on the type and colour of the fabric.

- Use different detergents for coloured and white laundry.
- Wash your delicate clothes only with special detergents (liquid detergent, wool shampoo, etc.) used solely for delicate clothes.
- When washing dark coloured clothes and quilts, it is recommended to use liquid detergent.
- Wash Woollens with special detergent made specifically for Woollens.

A

WARNING: Use only detergents manufactured specifically for washing machines.

WARNING: Do not use soap powder.

Adjusting detergent amount

The amount of washing detergent to be used depends on the amount of laundry, the degree of soiling and water hardness.

- Do not use amounts exceeding the dosage quantities recommended on the detergent package to avoid problems of excessive foam,

poor rinsing, financial savings and finally, environmental protection.

- Use lesser detergent for small amounts or lightly soiled clothes.

Preparation

Using softeners

Pour the softener into the softener compartment of the detergent drawer.

- Do not exceed the (>max<) level marking in the softener compartment.
- If the softener has lost its fluidity, dilute it with water before putting it in the detergent drawer.

Using liquid detergents

If the product contains a liquid detergent cup:

- Make sure that you have placed the liquid detergent cup in compartment nr. "2".
- If the liquid detergent has lost its fluidity, dilute it with water before putting in the detergent cup.



If the product does not contain a liquid detergent cup:

- Do not use liquid detergent for the prewash in a programme with prewash.
- Liquid detergent stains your clothes when used with Delayed Start function. If you are going to use the Delayed Start function, do not use liquid detergent.

Using gel and tablet detergent

Apply the following instructions when using tablet, gel and similar detergents.

- If the gel detergent thickness is fluidal and your machine does not contain a special liquid detergent cup, put the gel detergent into the main wash detergent compartment during first

Preparation

water intake. If your machine contains a liquid detergent cup, fill the detergent into this cup before starting the programme.

- If the gel detergent thickness is not fluidal or in the shape of capsule liquid tablet, put it directly into the drum before washing.
- Put tablet detergents into the main wash compartment (compartment nr. "2") or directly into the drum before washing.

C

Tablet detergents may leave residues in the detergent compartment. If you encounter such a case, place the tablet detergent between the laundry, close to the lower part of the drum in future washings.

Use the tablet or gel detergent without selecting the prewash function.

- Oxygen based bleaches can be used together with detergents; however, if its thickness is not the same with the detergent, put the

Using starch

- Add liquid starch, powder starch or the fabric dye into the softener compartment.
- Do not use softener and starch together in a washing cycle.
- Wipe the inside of the machine with a damp and clean cloth after using starch.

Using bleaches

- Select a programme with prewash and add the bleaching agent at the beginning of the prewash. Do not put detergent in the prewash compartment. As an alternative application, select a programme with extra rinse and add the bleaching agent while the machine is taking water from the detergent compartment during first rinsing step.
- Do not use bleaching agent and detergent by mixing them.
- Use just a little amount (approx. 50 ml) of bleaching agent and rinse the clothes very well as it causes skin irritation. Do not pour the bleaching agent onto the clothes and do not use it for coloured clothes.
- When using oxygen based bleaches, select a programme that washes at a lower temperature.

Preparation

detergent first into the compartment nr. "2" in the detergent drawer and wait until the detergent flows while the machine is taking in water. Add the bleaching agent from the same compartment while the machine is still taking in water.

Using limescale remover

- When required, use limescale removers manufactured specifically for washing machines only.

4.8 Tips for efficient washing

		Clothes			
		Light colours and whites	Colours	Dark colours	Delicates/Woolens/Silks
		(Recommended temperature range based on soiling level: 40-90°C)	(Recommended temperature range based on soiling level: cold-40°C)	(Recommended temperature range based on soiling level: cold-40°C)	(Recommended temperature range based on soiling level: cold-30°C)
Soiling Level	Heavily Soiled (difficult stains such as grass, coffee, fruits and blood.)	It may be necessary to pre-treat the stains or perform prewash. Powder and liquid detergents recommended for whites can be used at dosages recommended for heavily soiled clothes. It is recommended to use powder detergents to clean clay and soil stains and the stains that are sensitive to bleaches.	Powder and liquid detergents recommended for colours can be used at dosages recommended for heavily soiled clothes. It is recommended to use powder detergents to clean clay and soil stains and the stains that are sensitive to bleaches. Use detergents without bleach.	Liquid detergents suitable for colours and dark colours can be used at dosages recommended for heavily soiled clothes.	Prefer liquid detergents produced for delicate clothes. Woollen and silk clothes must be washed with special Woollen detergents.
	Normally Soiled (For example, stains caused by body on collars and cuffs)	Powder and liquid detergents recommended for whites can be used at dosages recommended for normally soiled clothes.	Powder and liquid detergents recommended for colours can be used at dosages recommended for normally soiled clothes. Use detergents without bleach.	Liquid detergents suitable for colours and dark colours can be used at dosages recommended for normally soiled clothes.	Prefer liquid detergents produced for delicate clothes. Woollen and silk clothes must be washed with special Woollen detergents.
	Lightly Soiled (No visible stains exist.)	Powder and liquid detergents recommended for whites can be used at dosages recommended for lightly soiled clothes.	Powder and liquid detergents recommended for colours can be used at dosages recommended for lightly soiled clothes. Use detergents without bleach.	Liquid detergents suitable for colours and dark colours can be used at dosages recommended for lightly soiled clothes.	Prefer liquid detergents produced for delicate clothes. Woollen and silk clothes must be washed with special Woollen detergents.

Operating the product

5.1 Control panel

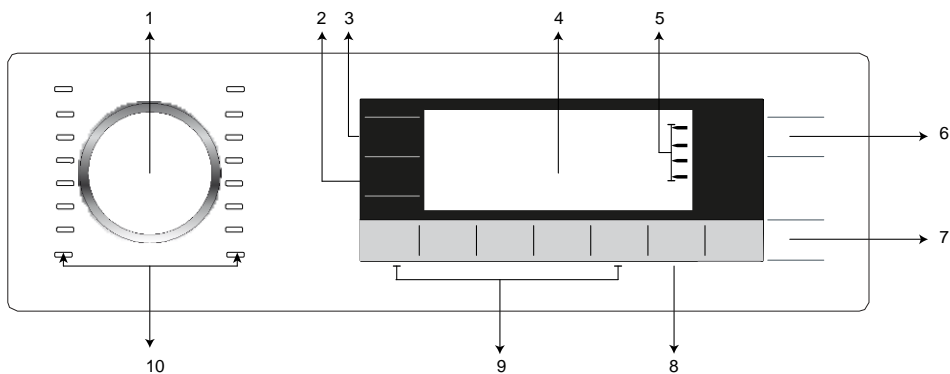

- 1 - Programme selection knob
- 2 - Spin Speed Adjustment button
- 3 - Temperature adjustment button
- 4 - Display
- 5 - Programme follow-up indicator
- 6 - On / Off button
- 7 - Start / Pause button
- 8 - End Time Adjustment button
- 9 - Auxiliary Function buttons
- 10 - Programme Selection lights

C

The visuals used for machine description in this section are schematic and may not match exactly with the features of your machine.

5.2 Display symbols

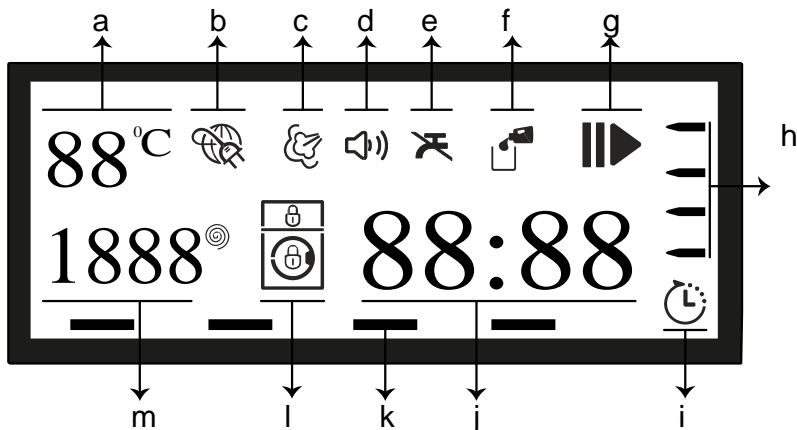

- a - Temperature indicator
- b - Electrical connection
- c - Steam indicator
- d - Audio Warning indicator
- e - No Water indicator
- f - Detergent indicator
- g - Start / Pause indicator
- h - Program Follow-up indicator
- i - End Time indicator
- j - Duration Information Line
- k - Auxiliary Function indicators
- l - Lock indicator
- m - Spin Speed indicator

5.3 Preparing the machine

- 1 Check if the hoses are connected tightly.
- 2 Plug in your machine.
- 3 Turn the tap on completely.
- 4 Place the laundry in the machine.
- 5 Add detergent and fabric softener.

5.4 Programme selection

- 1 Determine the programme suitable for the type, quantity and soiling level of the laundry in accordance with the "Programme and consumption table" and the temperature table below.

90°C	Heavily soiled white cottons and linens. (coffee table covers, tablecloths, towels, bed sheets, etc.)
60°C	Normally soiled, coloured, fade proof linens, cottons or synthetic clothes (shirt, nightgown, pajamas, etc.) and lightly soiled white linens (underwear, etc.)
40°C- 30°C- Cold	Blended laundry including delicate textile (veil curtains, etc.), synthetics and woolens.

- 2 Select the desired programme with the "Programme Selection" knob.

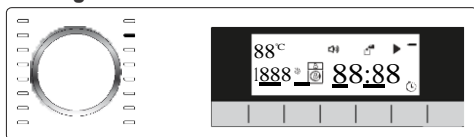

C	Programmes are limited with the highest spin speed appropriate for that particular type of fabric.
C	When selecting a programme, always consider the type of fabric, colour, degree of soiling and permissible water temperature.
C	Always select the lowest required temperature. Higher temperature means higher power consumption.

5.5 Programmes

Depending on the type of fabric, use the following main programmes.

• Cottons

Use this programme for your durable whites and colourfast cotton clothes. This programme is suggested for washing heavily soiled items.

• Synthetics

Use to wash your synthetic clothes (shirts, blouses, synthetic/cotton blends, etc.). It washes with a gentle action and has a shorter washing cycle compared to the Cottons programme.

For curtains and tulle, use the Synthetic 40°C programme with prewash and anti-creasing functions selected. As their meshed texture causes excessive foaming, wash the veils/tulle by putting little amount of detergent into the main wash compartment. Do not put detergent in the prewash compartment.

• Wool

Use to wash your woolen clothes. Select the appropriate temperature complying with the tags of your clothes. Use appropriate detergents for woolens.



WOOLMARK
APPROVED CARE

"The wool wash cycle of this machine has been approved by The Woolmark Company for the washing of machine washable wool products provided that the products are washed according to the instructions on the garment label and those issued by the manufacturer of this washing machine. M1403."

"In UK, Eire, Hong Kong and India the Woolmark trade mark is a Certification trade mark."

Operating the product

• Auto Program

Use to wash your frequently washable cotton, synthetic or blended (cotton+synthetic) clothes. Programme detects the type and quantity of the laundry to automatically adjust water consumption and programme time.



CAUTION: Do not wash your woolen and delicate clothes in this programme. Select a suitable temperature if the temperature shown on the temperature display is not compatible with the warnings on the garment label.

The maximum washing temperature in Automatic programme depending on the soiling level and laundry type is 60°C. Washing performance may not be at the desired level for heavily soiled whites and stubborn stains (collar, sock soil, perspiration stain, etc.). In this case, it is recommended to select Cottons programme with prewash and set the temperature to 50-60°C.

Many types of clothing are correctly detected and safely washed in Automatic programme.

Suitable clothes and the appropriate Automatic programme settings for washing them are shown in the table below.

Type of laundry	Laundry content	Selectable temperature levels	Max. laundry amount
Home textiles (duvet cover, bed sheet, pillowcase, coverlet, towel, bathrobe, table cloth, hand cloth, napkin, couch cover, beach towel, etc.).	Cotton, lycra	Cold - 60 °C	Full capacity
Underwear (undershirts, panties/slips, boxers, etc.), socks, pajamas	Cotton, lycra	Cold - 60 °C	Full capacity
Shirts	Cotton, polyester, linen	Cold - 60 °C	1/2 capacity
Knitted garments* (T-shirt, body, dress, lingerie, tights)	Cotton, polyamide (nylon), polyester, lycra	Cold - 40 °C	1/2 capacity
Sportswear (Sweatshirt, track suit, shorts, etc.)	Cotton, polyamide (nylon), polyester, microfiber, lycra	Cold - 40 °C	1/2 capacity
Jeans (trousers, jackets, vests, etc.)	Cotton, lycra	Cold - 40 °C	1/2 capacity
Corduroy and canvas clothes (trousers, shirts, etc.)	Cotton, lycra	Cold - 40 °C	1/2 capacity
Dark coloured clothes	Cotton, polyester, polyamide (nylon)	Cold - 40 °C	1/2 capacity

* Knitted clothes can easily shrink or stretch, crooked or pilled due to their elastic fabrics. Deformations on knitted fabrics are related with the quality of the cloth, and do not arise from washing programmes (Automatic or other washing programmes). Use "Sportswear" washing programme for knitted clothes.

Operating the product

Following table includes cloth types to be washed gently and some washing programmes suitable for some special clothes.

Special laundry type	Laundry content	Recommended washing programme
Blouse, dress, skirt, foulard	Viscose, modal, rayon, tencel, lyocell, angora	Hand Wash
Knitted, dress	Wool, acrylic	Woolens

Operating the product

• Cottons Eco

Use to wash your normally soiled, durable cotton and linen laundry. Although it washes longer than all other programmes, it provides high energy and water savings. Actual water temperature may be different from the stated wash temperature. When you load the machine with less laundry (e.g. ½ capacity or less), programme time may automatically get shorter. In this case, energy and water consumption will decrease more, providing a more economic wash. This programme is available in the models with the remaining time indicator.

• Anti-Allergy +

Use to wash baby laundry, and the laundry that belongs to allergic persons. Longer heating time and an additional rinsing step provide a higher level of hygiene.

• Anti-Allergy + 60°C programme is tested and approved by "The British Allergy Foundation" (Allergy UK) in United Kingdom.

• Delicates

Use to wash your delicate clothes. It washes with more gentle washing action compared to the Synthetics programme.

• Hand Wash

Use to wash your woolen/delicate clothes that bear "not machine-washable" tags and for which hand wash is recommended. It washes laundry with a very gentle washing action to not to damage clothes.

• Daily/Quick

Use to wash your lightly soiled and unstained cotton laundry in a short time.

• Quick 14

Use to wash your lightly soiled and unstained cotton laundry in a short time.

• Steam Therapy

Reduces creasing in dry garments and shortens ironing duration with its anti-wrinkle effect.

C Load only half of the capacity stated for the selected programme. When this programme is selected, it is normal to hear boiling noises since the steam generator boils water to produce steam.

• Shirts

Use to wash the shirts made of cotton, synthetic and synthetic blended fabrics together.

• Sports+Outdoor

Use this programme to wash your garments that are worn for a short time such as sportswear. It is suitable to wash little amount of cotton / synthetic blended garments.

• Bedding+Blanket

Use this programme to wash your fiber duvets that bear "machine washable" tag. Make sure that you have loaded the duvet correctly in order not to damage the machine and the duvet. Remove the duvet cover before loading the duvet into the machine. Fold the duvet into two and load it into the machine. Load the duvet into the machine paying attention to place it in a way that it will not contact the bellow.

C Do not load more than 1 double fibre duvet (200 x 200 cm).

C Do not wash your duvets, pillows and etc. that contain cotton in the machine.

A **CAUTION:** Do not wash the items apart from duvets such as carpets, rugs and etc. in the machine. Permanent damage occurs in the machine.

• Rinse

Use when you want to rinse or starch separately.

• Spin+Drain

Use to drain the water in the machine.

5.8 Temperature selection

Whenever a new programme is selected, the recommended temperature for the programme appears on the temperature indicator. It is possible that the recommended temperature value is not the maximum temperature that can be selected for the current programme.

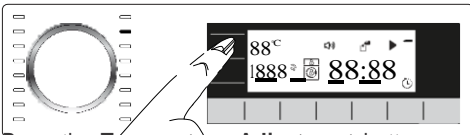

Press the **Temperature Adjustment** button to change the temperature. Temperature will decrease by steps of 10 °C.

C Temperature Adjustment button only serves for decreasing the temperature.

Finally, “-” symbol indicating the cold wash option appears on the display.

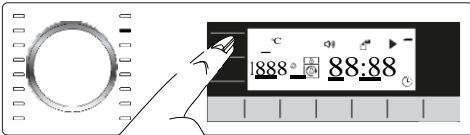

C No change can be made in programmes where temperature adjustment is not allowed.

You can also change the temperature after the washing starts. This change can be made if the washing steps allow it. Changes cannot be made if the steps do not allow it.

C If you scroll to cold wash option and press Temperature Adjustment button again, the recommended maximum temperature for the selected programme appears on the display. Press the Temperature Adjustment button again to decrease the temperature.

5.9 Spin speed selection

Whenever a new programme is selected, the recommended spin speed of the selected programme is displayed on the **Spin Speed** indicator.

C It is possible that the recommended spin speed value is not the maximum spin speed that can be selected for the current programme.

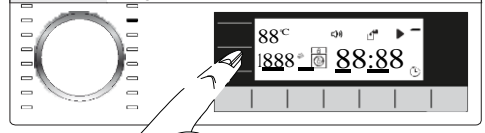

Press the **Spin Speed Adjustment** button to change the spin speed. Spin speed decreases gradually.

Then, depending on the model of the product, "Rinse Hold" and "No Spin" options appear on the display.

C **Spin Speed** Adjustment button only serves for decreasing the spin speed.

C Rinse Hold option is indicated with “|_” symbol and No Spin option is indicated with “_” symbol.

If you are not going to unload your laundry immediately after the programme completes, you can use **Rinse Hold** function in order to prevent them from getting wrinkled when there is no water

Operating the product

in the machine.

This function holds the laundry in the final rinsing water.

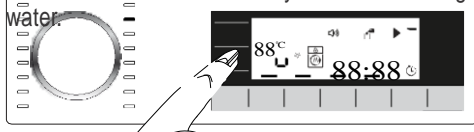

If you want to spin your laundry after the Rinse Hold function:

- Adjust the **Spin Speed**.
- Press **Start / Pause / Cancel** button. The programme resumes. Machine discharges the water and spins the laundry.

If you want to discharge the water at the end of the programme without spinning, use **No Spin**

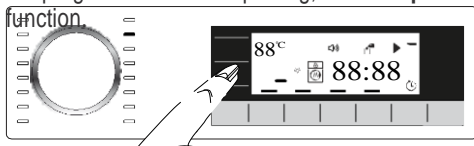

C

No change can be made in programmes where spin speed adjustment is not allowed.

You can change the spin speed after the washing starts if the washing steps allow it. Changes cannot be made if the steps do not allow it.

5.10 Programme and consumption table

EN	Programme	Max. Load (kg)	Water Consumption (l)	Energy Consumption (kWh)	Max. Speed**	Auxiliary functions			Selectable temperature range °C	
						Prewash	Quick	Extra Rinse		
	Cottons	90	8	58	2.60	1600	•	•	•	90-Cold
	Cottons	60	8	58	1.78	1600	•	•	•	90-Cold
	Cottons	40	8	58	0.97	1600	•	•	•	90-Cold
	Cottons Eco	40**	8	58	1.00	1600				40-Cold
	Bedding&Blanket	40	-	70	0.75	1000		•	•	60-Cold
	Anti-Allergy +	90	8	75	2.70	1600			*	90-30
	Auto Program	40	8	****	****	1600	•	•	•	Cold-60
	Quick 14	30	2	42	0.15	1400			•	30-Cold
	Daily/Quick	90	8	65	2.20	1400			•	90-Cold
	Daily/Quick	60	8	65	1.06	1400			•	90-Cold
	Daily/Quick	30	8	65	0.28	1400			•	90-Cold
	Synthetics	60	4	56	0.90	1000	•	•	•	60-Cold
	Synthetics	40	4	56	0.50	1000	•	•	•	60-Cold
	Sports&Outdoor	40	4	60	0.60	1000	•	•		40-Cold
	Shirts	60	4	65	1.15	800	•	•	•	60-Cold
	Delicates	40	3	54	0.44	1000	•	•	•	40-Cold
	Wool	40	2	45	0.31	1000		•	•	40-Cold
	Hand Wash	30	1.5	35	0.20	600				30-Cold
	Steam Therapy	-	1	1	0.17	-				-

- : Selectable.
- * : Automatically selected, no canceling.
- ** : Energy Label programme (AS/NZS 2040)
- **** : If maximum spin speed of the machine is lower then this value, you can only select up to the maximum spin speed.
- **** : Programme detects the type and quantity of the laundry to automatically adjust water and energy consumption and programme time.
- : See the programme description for maximum load.

C

The auxiliary functions in the table may vary according to the model of your machine.

Water and power consumption may vary subject to the changes in water pressure, water hardness and temperature, ambient temperature, type and amount of laundry, selection of auxiliary functions and spin speed, and changes in electric voltage.

You can see the washing time of the programme you have selected on the display of the machine. It is normal that small differences may occur between the time shown on the display and the real washing time.

Operating the product

“Selection patterns for auxiliary functions can be changed by the manufacturer company. New selection patterns can be added or removed.”

“The spin speed of your machine may vary according to the programme; this spin speed cannot exceed the max. spin speed of your machine.”

5.11 Auxiliary function selection

Select the desired auxiliary functions before starting the programme. Whenever a programme is selected, frames of the auxiliary function symbol that can be selected together with it illuminates. And when you select an auxiliary function, the interior area of the auxiliary function symbol also starts to illuminate.



C Frame of the auxiliary function symbol that cannot be selected with the current programme does not illuminate.

Also the frames of the auxiliary function suitable for the current programme after the washing has started remains illuminated. You can select or cancel the auxiliary functions whose frames are illuminated. If the wash cycle has reached a point where you cannot select the auxiliary function, the function's frame turns off.

C Some functions cannot be selected together. If a second auxiliary function conflicting with the first one is selected before starting the machine, the function selected first will be canceled and the second auxiliary function selection will remain active. For example, if you want to select Quick Wash after you have selected the Additional Water, Additional Water will be canceled and Quick Wash will remain active.

C An auxiliary function that is not compatible with the programme cannot be selected. (See, "Programme and consumption table")

C Some programmes have auxiliary functions that must be operated simultaneously. Those functions cannot be cancelled. The frame of the auxiliary function will not be illuminated, only inner area will be illuminated.

• Prewash

A Prewash is only worthwhile for heavily soiled laundry. Not using the Prewash will save energy, water, detergent and time.

• Quick

This function can be used in Cottons and Synthetics programmes. It decreases the washing times and also the number of rinsing steps for lightly soiled laundry.

C When you select this function, load your machine with half of the maximum laundry specified in the programme table.

• Extra Rinse

This function enables the machine to make another rinsing in addition to the one already made after the main wash. Thus, the risk for sensitive skins (babies, allergic skins, etc.) to be effected by the minimal detergent remnants on the laundry can be reduced.

• Rinse Hold

If you are not going to unload your clothes immediately after the programme completes, you can use rinse hold function to keep your laundry in the final rinsing water in order to prevent them from getting wrinkled when there is no water in the machine. Press Start / Pause button after this process if you want to drain the water without spinning your laundry. Programme will resume and complete after draining the water.

If you want to spin the laundry held in water, adjust the Spin Speed and press Start / Pause button.

The programme resumes. Water is drained, laundry is spun and the programme is completed.

Time display

Remaining time for the completion of the programme while it is running is displayed as "01:30" in hours and minutes format.

C Programme time may differ from the values in the "Programme and consumption table" depending on the water pressure, water hardness and temperature, ambient temperature, amount and the type of laundry, auxiliary functions selected and the changes at the mains voltage.

5.12 End Time

With the **End Time** function, the startup of the programme may be delayed up to 24 hours. **After pressing End Time** button, the programme's estimated ending time is displayed. **If the End Time** is adjusted, **End Time** indicator is illuminated.

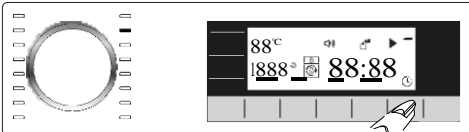

In order for the End Time function is activated and the programme is completed at the end of the specified time, you must press **Start / Pause** button after adjusting the time.

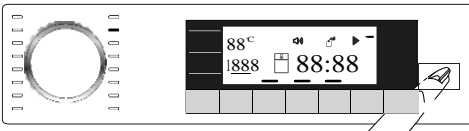

If you want to cancel End Time function, press **On / Off** button to turn off and on the machine.

C Do not use liquid detergents when you activate End Time function! There is the risk of staining of the clothes.

1 Open the loading door, place the laundry and put detergent, etc.

3 Set the end time of your choice by pressing the **End Time** button. **End Time** indicator illuminates.

4 Press **Start / Pause** button. Time countdown starts. ":" sign in the middle of the end time on the display starts flashing.

C **Additional laundry** may be loaded during the End Time countdown period. At the end of the countdown, End Time indicator turns off, washing cycle starts and the time of the selected programme appears on the display.

C **When the End Time** selection is completed, the time appears on the screen consists of end time plus the duration of the selected programme.

5.13 Starting the programme

1 Press **Start / Pause** button to start the programme.

2 The **Start / Pause** button which was off before starts to illuminate steadily now, indicating that the programme has started.

2 Select the washing programme, temperature, spin speed and, if required, the auxiliary functions.

Operating the product

8
8
c
1888
88:88

- 3 Loading door is locked. The door lock symbol appears on the display after the loading door is locked.

8
8
c
1888
88:88

- 4 Programme follow-up indicator lights on the display will show the current programme step.

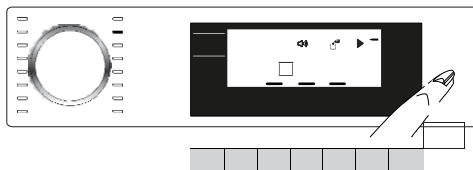
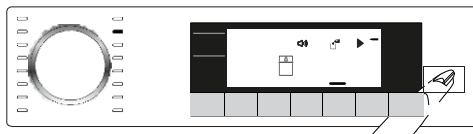

5.14 Loading door lock

There is a locking system on the loading door of the machine that prevents opening of the door in cases when the water level is unsuitable.

"Door Locked" symbol appears on the display when the loading door is locked.

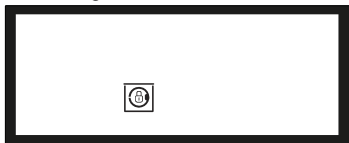

5.15 Changing the selections after the programme has started

Adding laundry after the programme has started:

If the water level in the machine is suitable when you press **Start / Pause** button, loading door symbol will flash on the display until the loading door is opened and will disappear when the loading door is opened.

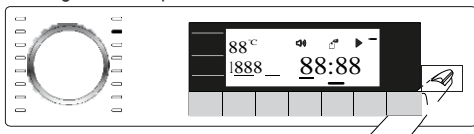

If the water level in the machine is not suitable when you press **Start / Pause** button, the loading door symbol remain lit on the display.

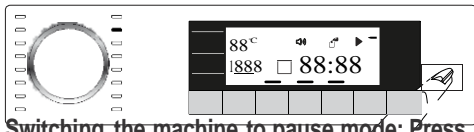

Switching the machine to pause mode: Press the **Start / Pause** button to switch the machine to pause mode. Pause symbol will flash on the display.

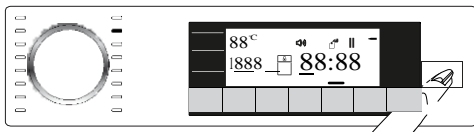

Changing the programme selection after programme has started:

The programme change is not allowed when the current programme is running.

You can select the new programme after switching the current programme to standby.

C The selected program starts anew.

Changing the auxiliary function, speed and temperature

Depending on the step the programme has reached, you can cancel or activate the auxiliary functions. See, "Auxiliary function selection".

You can also change the speed and temperature settings. See, "Spin speed selection" and "Temperature selection"

C The loading door will not open if the water temperature in the machine is high or the water level is above the door opening.

5.16 Child Lock

Use Child Lock function to prevent children from tampering with the machine. Thus you can avoid any changes in a running programme.

C You can switch on and off the machine with **On / Off** button when the Child Lock is active. When you switch on the machine again, programme will resume from where it has stopped.

C When the child lock is enabled, an audio warning will be given and buttons are disabled if the buttons are pressed 5 times consecutively.

To activate the Child Lock:

Press and hold Auxiliary Function button 2 for 3 seconds. After the countdown as "CL 3-2-1" on the display is over, "Child Lock Enabled" appears on the display. You can release **Auxiliary Function button 1** when this warning is displayed.

To deactivate the childproof lock:

Press and hold **Auxiliary Function** button 2 for 3 seconds. After the countdown as "CL 3-2-1" on the display is over, "Child Lock Enabled" disappears from the display.

5.17 Canceling the programme

The programme is cancelled when the machine is turned off and on again. Press and hold **On / Off** button for 3 seconds. After the countdown as "3-2-1" on the display is over, the machine turns off.

C If you press **On / Off** button when the Child Lock is enabled, the programme will not be cancelled. You should cancel the Child Lock first.

C If you want to open the loading door after you have cancelled the programme but it is not possible to open the loading door since the water level in the machine is above the loading door opening, then turn the **Programme Selection** knob to **Pump+Spin** programme and discharge the water in the machine.

5.18 End of programme

End symbol appears on the display when the programme is completed.

If you do not press any button for 10 minutes, the machine will switch to OFF mode. Display and all indicators are turned off.

Completed programme steps will be displayed if you press **On / Off** button.

5.19 Adjusting the VOLUME level

Low volume and high volume

Press and hold **Auxiliary Function** button 3 for 3 seconds to adjust the volume level. After the countdown as "3-2-1" on the display is over, the volume level symbol will appear and the new volume level will be displayed.

5.20 Memory program setting

You can create a favourite programme by saving frequently used programme and other settings. Use this function when you want to select quickly the same settings you use for the laundry that you wash regularly.

Memory programme will remain at the factory set programme until you make a new favourite programme setting.

To store a new Memory programme:

- 1 Select the desired programme, temperature, spin speed, soiling degree and auxiliary function.
- 2 Keep the **Memory** button pressed for 3 seconds.
- 3 Countdown as "3-2-1" appears on the display.

To select a Memory programme:

- 1 Press **Memory** button. The "Memory" selection field will be activated on the display.
- 2 Programme and other settings saved as Memory appear on the display.
- 3 Press **Start / Pause** button to start the Memory programme.

Maintenance and cleaning

Service life of product extends and frequently experienced problems will be reduced if it is cleaned at regular intervals.

6.1 Cleaning the detergent drawer

Clean the detergent drawer at regular intervals (every 4-5 washing cycles) as shown below in order to prevent accumulation of powder detergent in time.

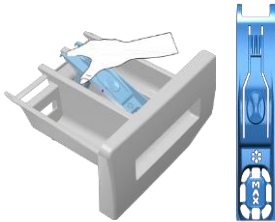

Lift the rear part of the siphon to remove it as illustrated.

C If water and softener more than a normal amount start to accumulate on the softener compartment, perform siphon cleaning.

2. Wash the detergent drawer and the siphon with plenty of lukewarm water in a washbasin. In order to prevent the residues to contact your skin, clean it with an appropriate brush by wearing a pair of gloves.
- 3 After cleaning, replace the siphon back to its seating and push its front section downwards to make sure that the locking tab engages.

6.2 Cleaning the loading door and the drum

For products with drum cleaning programme, please see Operating the product - Programmes. For products without drum cleaning, follow the below steps to **clean the drum**:

Select **Additional Water** or **Extra Rinse** auxiliary functions. Use a **Cottons programme** without pre-wash. Set the **temperature to the level recommended on the drum cleaning agent which can be provided from authorized services**. Apply this procedure **without any laundry in the product**. Before starting the programme, put 1 pouch of special drum cleaning agent (if the special agent could not be supplied, put max. 100 g of powder anti-limescale) into the main wash detergent compartment (compartment no. „2“). If the anti-limescale is in tablet form, put only one tablet into the main wash compartment no. „2“. Dry the inside of the bellow with a clean piece of cloth after the programme has come to an end.

C Repeat the drum cleaning work at every 2 months.
Use an anti-limescale suitable for the washing machines.

Check and make sure that there is not any foreign bodies left inside the drum after each wash.

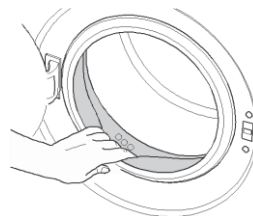

If the holes in the bellows shown in the Figure are clogged, open the holes by means of a toothpick.

C Rust stains may form inside the drum due to the metal objects. Clean the stains on the surface of the boiler with stainless

Maintenance and cleaning

steel cleaning agents. Never use steel wool or wire wool.

A

CAUTION: Never use sponge or scrub materials. These will damage the painted and plastic surfaces.

6.3 Cleaning the body and control panel

Wipe the body of the machine with soapy water or non-corrosive mild gel detergents as necessary, and dry with a soft cloth.

Use only a soft and damp cloth to clean the control panel.

6.4 Cleaning the water intake filters

There is a filter at the end of each water intake valve at the rear of the machine and also at the end of each water intake hose where they are connected to the tap. These filters prevent the foreign substances and dirt in the supply water to enter into the machine. Filters should be cleaned when they become dirty.

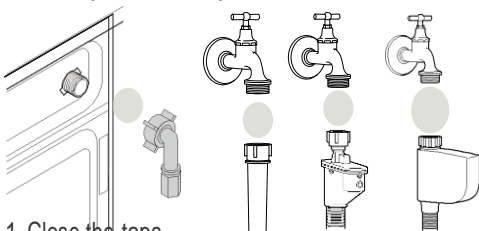

1. Close the taps.
2. Remove the nuts of the water intake hoses to access the filters on the water intake valves. Clean them with an appropriate brush. If the filters are too dirty, remove them from their places with a pliers and clean in this way.
3. Take out the filters on the flat ends of the water intake hoses together with the gaskets and

- clean thoroughly under running water.
4. Replace the seals and filters carefully and tighten their nuts by hand.

6.5 Draining remaining water and cleaning the pump filter

The filter system in your machine prevents solid items such as buttons, coins and fabric fibers clogging the pump impeller during discharge of washing water. Therefore the waste water is discharged without any problems and the service life of the pump is increased.

If the machine does not drain the water, pump filter may have been clogged. Filter should be cleaned when clogged or once in 3 months. In order to clean the pump filter, first the water should be drained.

Also, before transporting the machine (for example when moving to new house) and when the water has the risk of freezing, water may have to be fully drained.

A

CAUTION: Foreign objects which stay inside the pump filter may damage your machine or cause noise problem.

CAUTION: If the product is not being used, shut the tap shut, remove mains pipe and drain the water inside the machine against any likely freezing.

CAUTION: Shut the tap which the mains pipe of the product is connected to after each use.

In order to clean the dirty filter and discharge the water:

- 1 Unplug the machine to cut off the supply power.

A

CAUTION: Temperature of the water inside the machine may rise up to 90 °C. To avoid the burning risk, clean the filter after the water inside the machine is cooled down.

2. Open the filter cover.



3. While some of our products are equipped with an emergency water drain hose, some are not. Follow the below procedures in order to drain water.

If the product has an emergency water draining hose, in order to drain the water:

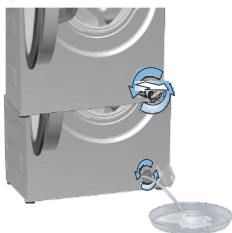

- a Pull away the emergency water draining hose from its housing.
- b Put the larger end of the hose into a large vessel. Pull and remove the plug at the end of the hose and drain the water into a vessel. When the vessel is full, shut the nozzle of the hose by inserting the plug into it. After you empty the vessel, repeat above procedures and drain the water inside the machine fully.
- c When the water drainage is complete, block its nozzle again with the plug and secure the hose into its place.
- d Turn and remove the pump filter.

If the product does not have an emergency water drain hose, in order to drain the water:

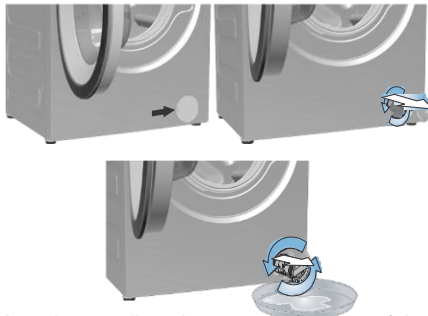

- a. In order to collect the water to flow out of the filter, place a large vessel in front of the filter.
 - b. Turn and loosen the pump filter until water starts to flow (counterclockwise). Fill the flowing water into the vessel which you put in front of the filter. Always keep a piece of cloth handy to absorb any spilled water.
 - c. When the water in the machine ceases, turn the pump filter and remove it fully.
- Clean any residues inside the filter as well as fibers, if any, around the pump impeller region.
5. Replace the filter.
 6. If the filter cap is composed of two pieces, close the filter cap by pressing on the tab. If it is one piece, seat the tabs in the lower part into their places first, and then press the upper part to close.

Troubleshooting

Problem	Reason	Solution
Program does not start after closing the door.	Start / Pause / Cancel button was not pressed.	§ <i>Press the Start / Pause / Cancel button.</i>
Programme cannot be started or selected.	Washing machine has switched to self protection mode due to a supply problem (line voltage, water pressure, etc.).	§ <i>Press and hold Start / Pause / Cancel button for 3 seconds to reset the machine to factory settings. (see. "Cancellation of program")</i>
Water in the machine.	Some water might have remained in the product due to the quality control processes in the production.	§ <i>This is not a failure; water is not harmful to the machine.</i>
Machine does not fill with water.	Tap is turned off.	§ <i>Turn on the taps.</i>
	Water inlet hose is bent.	§ <i>Flatten the hose.</i>
	§ <i>Water inlet filter is clogged.</i>	§ <i>Clean the filter.</i>
	Loading door may be open.	§ <i>Close the door.</i>
Machine does not drain water.	Water drain hose might be clogged or twisted.	§ <i>Clean or flatten the hose.</i>
	Pump filter is clogged.	§ <i>Clean the pump filter.</i>
Machine vibrates or makes noise.	Machine might be standing unbalanced.	§ <i>Adjust the feet to level the machine.</i>
	A hard substance might have entered into the pump filter.	§ <i>Clean the pump filter.</i>
	Transportation safety bolts are not removed.	§ <i>Remove the transportation safety bolts.</i>
	Laundry quantity in the machine might be too little.	§ <i>Add more laundry to the machine.</i>
	Machine might be overloaded with laundry.	§ <i>Take out some of the laundry from the machine or distribute the load by hand to balance it homogenously in the machine.</i>
	Machine might be leaning on a rigid item.	§ <i>Make sure that the machine is not leaning on anything.</i>
There is water leaking from the bottom of the washing machine.	Water drain hose might be clogged or twisted.	§ <i>Clean or flatten the hose.</i>
	Pump filter is clogged.	§ <i>Clean the pump filter.</i>
Machine stopped shortly after the programme started.	Machine might have stopped temporarily due to low voltage.	§ <i>It will resume running when the voltage restores to the normal level.</i>
Machine directly discharges the water it takes in.	Draining hose might not be at adequate height.	§ <i>Connect the water draining hose as described in the operation manual.</i>

Troubleshooting

No water can be seen in the machine during washing.

The water level is not visible from outside of the washing machine.

§ *This is not a failure.*

Troubleshooting

Problem	Reason	Solution
Loading door cannot be opened.	Door lock is activated because of the water level in the machine.	§ Drain the water by running the Pump or Spin programme.
	Machine is heating up the water or it is at the spinning cycle.	§ Wait until the programme completes.
	Child lock is engaged. Door lock will be deactivated a couple of minutes after the programme has come to an end.	§ Wait for a couple of minutes for deactivation of the door lock.
Washing takes longer time than specified in the manual.(*)	Water pressure is low.	§ Machine waits until taking in adequate amount of water to prevent poor washing quality due to the decreased amount of water. Therefore, the washing time extends.
	Voltage might be low.	§ Washing time is prolonged to avoid poor washing results when the supply voltage is low.
	Input temperature of water might be low.	§ Required time to heat up the water extends in cold seasons. Also, washing time can be lengthened to avoid poor washing results.
	Number of rinses and/or amount of rinse water might have increased.	§ Machine increases the amount of rinse water when good rinsing is needed and adds an extra rinsing step if necessary.
	Excessive foam might have occurred and automatic foam absorption system might have been activated due to too much detergent usage.	§ Use recommended amount of detergent.
Programme time does not countdown. (On models with display) (*)	Timer may stop during water intake.	§ Timer indicator will not countdown until the machine takes in adequate amount of water. The machine will wait until there is sufficient amount of water to avoid poor washing results due to lack of water. Timer indicator will resume countdown after this.
	Timer may stop during heating step.	§ Timer indicator will not countdown until the machine reaches the selected temperature.
	Timer may stop during spinning step.	§ Automatic unbalanced load detection system might be activated due to the unbalanced distribution of the laundry in the drum.
Programme time does not countdown. (*)	There might be unbalanced load in the machine.	§ Automatic unbalanced load detection system might be activated due to the unbalanced distribution of the laundry in the drum.

Troubleshooting

Problem	Reason	Solution
Machine does not switch to spinning step. (*)	There might be unbalanced load in the machine.	§ Automatic unbalanced load detection system might be activated due to the unbalanced distribution of the laundry in the drum.
	The machine will not spin if water is not drained completely.	§ Check the filter and the draining hose.
	Excessive foam might have occurred and automatic foam absorption system might have been activated due to too much detergent usage.	§ Use recommended amount of detergent.
Washing performance is poor: Laundry turns gray. (**)	Insufficient amount of detergent has been used over a long period of time.	§ Use the recommended amount of detergent appropriate for water hardness and the laundry.
	Washing was made at low temperatures for a long time.	§ Select the proper temperature for the laundry to be washed.
	Insufficient amount of detergent is used with hard water.	§ Using insufficient amount of detergent with hard water causes the soil to stick on the cloth and this turns the cloth into gray in time. It is difficult to eliminate graying once it happens. Use the recommended amount of detergent appropriate for water hardness and the laundry.
	Too much detergent is used.	§ Use the recommended amount of detergent appropriate for water hardness and the laundry.
Washing performance is poor: Stains persist or the laundry is not whitened. (**)	Insufficient amount of detergent is used.	§ Use the recommended amount of detergent appropriate for water hardness and the laundry.
	Excessive laundry was loaded in.	§ Do not load the machine in excess. Load with amounts recommended in the "Programme and consumption table".
	Wrong programme and temperature were selected.	§ Select the proper programme and temperature for the laundry to be washed.
	Wrong type of detergent is used.	§ Use original detergent appropriate for the machine.
	Too much detergent is used.	§ Put the detergent in the correct compartment. Do not mix the bleaching agent and the detergent with each other.
Washing performance is poor: Oily stains appeared on the laundry. (**)	Regular drum cleaning is not applied.	§ Clean the drum regularly. For this, please see 6.2.

Troubleshooting

Problem	Reason	Solution
Washing performance is poor: Clothes smell unpleasantly. (**)	Odours and bacteria layers are formed on the drum as a result of continuous washing at lower temperatures and/or in short programmes.	§ Leave the detergent drawer as well as the loading door of the machine ajar after each washing. Thus, a humid environment favorable for bacteria cannot occur in the machine.
Colour of the clothes faded. (**)	Excessive laundry was loaded in.	§ Do not load the machine in excess.
	Detergent in use is damp.	§ Keep detergents closed in an environment free of humidity and do not expose them to excessive temperatures.
	A higher temperature is selected.	§ Select the proper programme and temperature according to the type and soiling degree of the laundry.
It does not rinse well.	The amount, brand and storage conditions of the detergent used are inappropriate.	§ Use a detergent appropriate for the washing machine and your laundry. Keep detergents closed in an environment free of humidity and do not expose them to excessive temperatures.
	Detergent is put in the wrong compartment.	§ If detergent is put in the prewash compartment although prewash cycle is not selected, machine can take this detergent during rinsing or softener step. Put the detergent in the correct compartment.
	Pump filter is clogged.	§ Check the filter.
	Drain hose is folded.	§ Check the drain hose.
Laundry became stiff after washing. (**)	Insufficient amount of detergent is used.	§ Using insufficient amount of detergent for the water hardness can cause the laundry to become stiff in time. Use appropriate amount of detergent according to the water hardness.
	Detergent is put in the wrong compartment.	§ If detergent is put in the prewash compartment although prewash cycle is not selected, machine can take this detergent during rinsing or softener step. Put the detergent in the correct compartment.
	Detergent might be mixed with the softener.	§ Do not mix the softener with detergent. Wash and clean the dispenser with hot water.

Troubleshooting

Problem	Reason	Solution
Laundry does not smell like the softener. (**)	Detergent is put in the wrong compartment.	§ If detergent is put in the prewash compartment although prewash cycle is not selected, machine can take this detergent during rinsing or softener step. Wash and clean the dispenser with hot water. Put the detergent in the correct compartment.
	Detergent might be mixed with the softener.	§ Do not mix the softener with detergent. Wash and clean the dispenser with hot water.
Detergent residue in the detergent drawer. (**)	Detergent is put in wet drawer.	§ Dry the detergent drawer before putting in detergent.
	Detergent has gotten damp.	§ Keep detergents closed in an environment free of humidity and do not expose them to excessive temperatures.
	Water pressure is low.	§ Check the water pressure.
	The detergent in the main wash compartment got wet while taking in the prewash water. Holes of the detergent compartment are blocked.	§ Check the holes and clean if they are clogged.
	There is a problem with the detergent drawer valves.	§ Call the Authorized Service Agent.
	Detergent might be mixed with the softener.	§ Do not mix the softener with detergent. Wash and clean the dispenser with hot water.
	Regular drum cleaning is not applied.	§ Clean the drum regularly. For this, please see 6.2.
Too much foam forms in the machine. (**)	Improper detergents for the washing machine are being used.	§ Use detergents appropriate for the washing machine.
	Excessive amount of detergent is used.	§ Use only sufficient amount of detergent.
	Detergent was stored under improper conditions.	§ Store detergent in a closed and dry location. Do not store in excessively hot places.
	Some meshed laundry such as tulle may foam too much because of their texture.	§ Use smaller amounts of detergent for this type of item.
	Detergent is put in the wrong compartment.	§ Put the detergent in the correct compartment.
	Softener is being taken early.	§ There may be problem in the valves or in the detergent dispenser. Call the Authorized Service Agent.

Troubleshooting

Problem	Reason	Solution
Foam is overflowing from the detergent drawer.	Too much detergent is used.	§ Mix 1 tablespoonful softener and ½ l water and pour into the main wash compartment of the detergent drawer.
		§ Put detergent into the machine suitable for the programmes and maximum loads indicated in the "Programme and consumption table". When you use additional chemicals (stain removers, bleaches and etc), reduce the amount of detergent.
Laundry remains wet at the end of the programme. (*)	Excessive foam might have occurred and automatic foam absorption system might have been activated due to too much detergent usage.	§ Use recommended amount of detergent.

(*) Machine does not switch to spinning step when the laundry is not evenly distributed in the drum to prevent any damage to the machine and to its surrounding environment. Laundry should be rearranged and re-spun.

(**) Regular drum cleaning is not applied. Clean the drum regularly. See 6.2

A

CAUTION: If you cannot eliminate the problem although you follow the instructions in this section, consult your dealer or the Authorized Service Agent. Never try to repair a nonfunctional product yourself.

