

FR GUIDE D'INSTALLATION & D'UTILISATION
EN INSTRUCTIONS FOR USE
IT MANUALE DI INSTALLAZIONE & DI USO
DE GEBRAUCHSANWEISUNG
NL HANDLEIDING VOOR HET INSTALLEREN
EN HET GEBRUIK

Brandt

Lave-Linge
Washing machine
Lavabiancheria
Waschmaschine
Wasmachine



FR Page 3

Dans le souci d'une amélioration constante de nos produits, nous nous réservons le droit d'apporter à leurs caractéristiques techniques, fonctionnelles ou esthétiques toutes modifications liées à leur évolution.

Important :

Avant de mettre votre appareil en route, veuillez lire attentivement ce guide d'installation et d'utilisation afin de vous familiariser plus rapidement avec son fonctionnement

EN Page 13

As part of our commitment to constantly improving our products, we reserve the right to make changes to them based on technical advances to their technical and functional features and appearance.

Warning :

Before installing and using your appliance, please carefully read this Guide to Installation and Use, which will allow you to quickly familiarise yourself with its operation.

IT Pagina 23

Con il costante scrupolo di migliorare i nostri prodotti, ci riserviamo il diritto di apportare modifiche alle loro caratteristiche tecniche, funzionali o estetiche, parallelamente all'evoluzione tecnica.

Importante :

Prima di avviare l'apparecchio, leggere attentamente questa guida d'installazione e di utilizzo al fine di conoscerne rapidamente il funzionamento.

DE Seite 33

Da wir unsere Produkte ständig verbessern möchten, behalten wir uns das Recht vor, ihre technischen, funktionellen und ästhetischen Merkmale zu verändern, damit sie mit der technischen Weiterentwicklung Schritt halten.

Wichtig:

Bitte lesen Sie vor der Inbetriebnahme des Gerätes diese Einbau- und Gebrauchsanleitung aufmerksam durch, damit Sie sich rasch mit seinem Betrieb vertraut machen können.

NL Pagina 43

Wij streven voortdurend naar verbetering van onze producten. Daarom behouden we ons het recht voor om aan de technische, functionele of esthetische kenmerken van onze producten wijzigingen aan te brengen die in verband staan met technische ontwikkelingen.

Belangrijk:

Vóór installatie en gebruik van uw apparaat deze installatie- en gebruiksgids aandachtig lezen. U zult snel gewend raken aan de werking.

• CONTENTS

	Page		Page
Removing the transport packing	14	Programming	16
Moving your machine	14	Children's safety system	18
Connecting to the cold water supply	14	Details of the programmes and options	18
Draining away the waste water	14	Modifying a washing programme	20
Connecting to the electricity supply	15	Automatic safety systems	20
Installing your machine	15	Cleaning the pump filter	21
Loading your washing	15	Maintaining your machine	21
Loading the washing products	15	Incidents that may arise	22
		Messages shown on the display	22

Dear Customer,

You have just acquired a **BRANDT** washing machine and we would like to thank you.

We have invested all our dedication and know-how in this appliance so that it would best meet your needs. With innovation and performance, we designed it to be always easy to use.

In the **BRANDT** product range, you will also find a wide choice of ovens, microwaves, cooking hobs, ventilation hoods, cookers, dishwashers, driers, fridges and freezers, that you can coordinate with your new **BRANDT** washing machine.

Visit our website www.brandt.com where you will find all of our products, as well as useful and complementary information.

www.brandt.com

BRANDT

• SAFETY ADVICE

! Important :

This machine is only for domestic use and is designed to wash, rinse and spin machine-washable textiles.

You must observe the following instructions. We refuse to accept any liability and the guarantee if you do not observe these recommendations since this could result in damage to equipment or physical injury.

– This appliance is not intended for use by persons (including children) with reduced physical, sensory or mental capabilities, or lack of experience and knowledge, unless they have been given supervision or instruction concerning use of the appliance by a person responsible for their safety.

– The machine must only be used in accordance with its normal method of operation in order to avoid damaging your washing and your machine. Only use washing and maintenance products certified for use in domestic washing machines.

– If you pre-treat your washing with stain removers, solvents or, in general, any inflammable or potentially highly explosive product, do not insert them into the machine immediately.

Furthermore, you are also recommended not to use solvents or products in aerosol cans near to your washing machine or any electrical appliance in general in a poorly ventilated room (risk of fire and explosion).

– If any incidents occur and you cannot resolve them using the remedies we recommend (see the section "INCIDENTS THAT MAY ARISE"), call in a qualified professional.

– If you have to open your machine during a cycle (for example, to add or remove washing), depending on the stage the programme is at (during washing essentially), be careful of the temperature inside the machine, which may be very high (risk of severe burns).

– When making a new installation, the machine must be connected to the water supply with a new hose: the old hose must not be re-used.

– Do not let children play with the machine and keep your pets away from it.

– You must immediately make any obsolete machine unusable. Disconnect and cut off the power cable flush with the machine. Close the water tap and remove the hose. Disable the door lock.

– If there is a risk of frost, disconnect the water hose and drain off any water that may remain in the drain hose by placing this as low as possible in a bowl.

• SAVING ENERGY

– Only programme a prewash when it is absolutely necessary: for example, for very dirty sports or working clothes, etc.

– A low temperature programme is sufficient for impeccable washing results when your washing is only slightly or moderately dirty.

– For washing that is only slightly dirty, select a short washing cycle .

– Use the right amount of washing products for the hardness of the water, the amount of washing and how dirty it is and follow the instructions on the detergent packs.

• ENVIRONMENTAL PROTECTION

This appliance's packaging material is recyclable. Help recycle it and protect the environment by dropping it off in the municipal receptacles provided for this purpose.

 Your appliance also contains a great amount of recyclable material. It is marked with this label to indicate that in countries that are a members of the European Union the used appliances should not be mixed with other waste.

This way, the appliance recycling organised by your manufacturer will be done under the best possible conditions, in compliance with European Directive 2002/96/EC on Waste Electrical and Electronic Equipment. Contact your town hall or your retailer for the used appliance collection points closest to your home.

We thank you doing your part to protect the environment.

• DESCRIPTION OF YOUR MACHINE

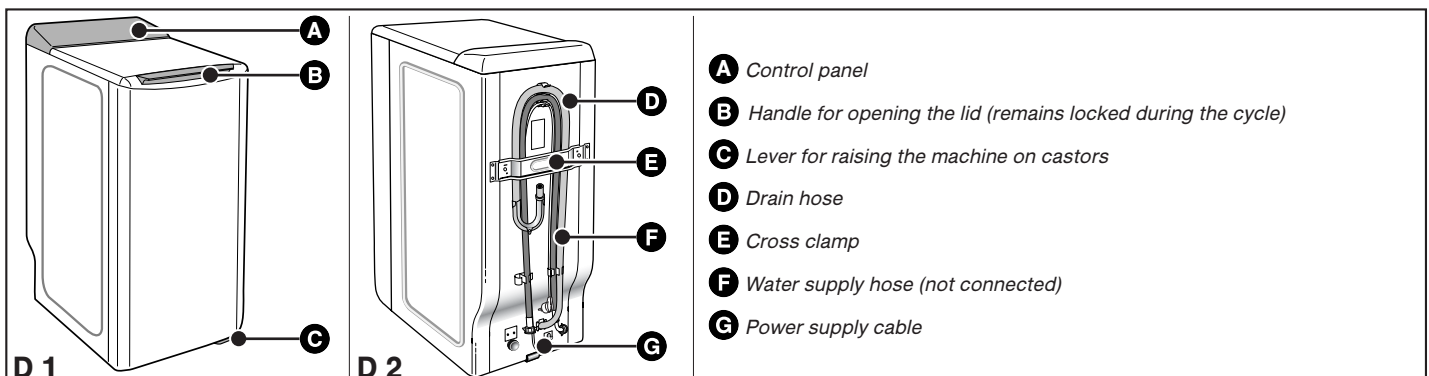

- A** Control panel
- B** Handle for opening the lid (remains locked during the cycle)
- C** Lever for raising the machine on castors
- D** Drain hose
- E** Cross clamp
- F** Water supply hose (not connected)
- G** Power supply cable

• REMOVING THE TRANSPORT CLAMPS

⚠ Important :
 Before using the machine in any way, you must first perform the following operations.

These comprise removing all the components designed to immobilise the drum in your machine during transport.

These so-called “releasing” operations are necessary for your machine to operate correctly and to conform to the prevailing safety standards. If they are not carried out completely, this could cause severe damage to your machine while it is operating.

– Remove the washing machine from its plinth (check that the wedge **A** supporting the motor is not still inserted in the machine) (Diagram D3)

– Remove the 4 screws **B** with a screwdriver (Diagram D4)

– Remove the cross clamp **C** by removing the 2 screws **D** (Diagram D5) using a 10 or 13mm spanner (depending on the model). (Ensure that you remove the two plastic braces fixed on the cross clamp at the same time as the clamp itself).

– Replace the screws **B** in their initial positions.

⚡ Warning:
 You must block off the two holes using the hole covers provided **E** (supplied in the accessories bag) (Diagram D6)

– Remove the drum-tank assembly locking wedge (Diagram D7).

To do this:

- Lift the lid on the machine
- Remove wedge **F**
- Remove wedge **G**
- Release the drum doors, locked in the lower position, by pressing down on both eaves simultaneously.

⚡ Warning:
 Remove the pipe support collars **H** You must block off the holes revealed with the hole covers **I** supplied in the accessories bag (Diagram D8).

🔍 Advice:
 We would recommend that you keep all the locking components since these must be refitted if you must subsequently transport your machine again.

🔍 Information:
 Your machine has been scrupulously checked before it left the factory. You may therefore notice a little water still remaining in the tank or the products box.

• MOVING YOUR MACHINE

• Mounting it on castors

If your machine is equipped with removable castors, you will be able to move it quite easily.

To mount it on castors, swivel the lever on the bottom of the machine from the right to the far left (Diagram D9).

⚠ Important:
 The machine must not rest on the “front” castors while it is operating: remember to return the lever to its initial position.

• CONNECTING TO THE COLD WATER SUPPLY

Connect the supply hose (Diagram D10) :

– At one end to the connection on the back of the machine

– On the other end to a tap fitted with a threaded end 20mm dia. x 27 (3/4 BSP).

If you use a self-piercing tap, the useful aperture must have a minimum diameter of 6mm.

Water supply:

- Minimum water pressure: 0.1 MPa or 1 bar

- Maximum water pressure: 1 MPa or 10 bars

• Replacing a water supply hose

When replacing the hose, ensure that the hose is tightly fastened and that there is a seal at both ends.

• DRAINING AWAY THE WASTE WATER

Fit the hose bracket provided inside your machine to the end of the drain hose and then connect the hose (Diagram D11) :

– Either, temporarily, over a sink or a bathtub.

– Or permanently to a ventilated U-bend.

If your installation does not have a ventilated U-bend, check that the connection is not sealed. In fact, to avoid any waste water flowing back into the machine, you are strongly recommended to leave an air gap between the machine’s drain hose and the drainpipe.

In any case, the drain hose bracket must be placed at a height of 65 to 90 cm higher than the base of the machine.

⚠ Important:
 Ensure that the drain hose is tied firmly in place with cord to avoid the bracket coming loose during draining and causing a flood. For correct draining of the waste water, make sure that the drain hose is as straight as possible. In fact, the more bends the less effective the drain pump.

The waste water can be drained away to the ground provided that the drain hose passes through a point 65 to 90 cm higher than the base of the machine (Diagram D12).

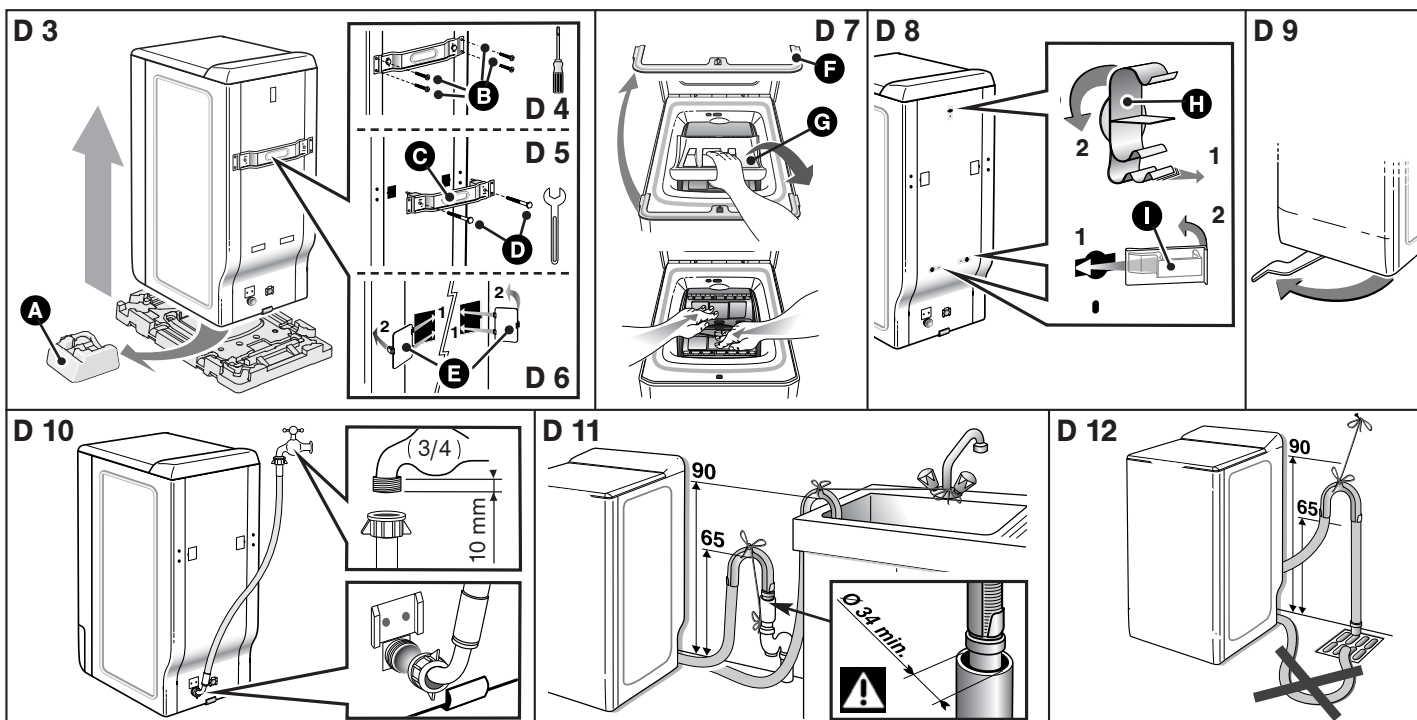

• CONNECTING TO THE ELECTRICITY SUPPLY

⚠ Important:

For your safety, you must comply with the instructions below.
– Before connecting your machine, you must ensure that your installation's electrical characteristics match those of your machine (see the details provided on the information plate affixed to the back of the machine).

The electrical installation must comply with the prevailing standards and the Electricity Board's regulations in the country concerned, **particularly as regards Earthing** and installation in shower rooms.

We cannot be held responsible for any incident caused by the machine being incorrectly earthed.

🔍 Advice:

Advice on the electrical installation of your machine

- Do not use an extension lead, adapter or multiple socket.
- **Never** cut out the Earth wire.
- The socket must be readily accessible but out of the reach of children.

If in any doubt, please contact your installer.

⚠ Important:

Your machine conforms to European Directives 2006/95/CE (Low Voltage Directive) and 2004/108/CE (Electromagnetic Compatibility).

• INSTALLING YOUR MACHINE

⚠ Important:

If you are installing your machine next to another machine or a unit, we recommend that you leave a gap between them to allow for air circulation.

🔍 Advice:

We also strongly recommend that you do NOT:

- Install your machine in a damp, poorly ventilated room.
- Install your machine in an area where it could be subject to water splashes.

– Install your machine on a carpeted floor.

If you cannot avoid doing this, please take every precaution to avoid blocking air circulation at the bottom of the machine in order to ensure that the internal components are well ventilated.

• Levelling the machine:

Use a spirit level to check that the floor is horizontal: maximum slope 2°, i.e. a discrepancy of approximately 1cm over the width and of 1.5cm over the depth of the machine.

• Adjustable feet

Some machines are fitted with two adjustable feet at the front to enable you to compensate for any unevenness in the floor. Proceed as follows to adjust the feet to level and stabilize your machine:

- Set the machine on its castors (or tilt it slightly backwards if it does not have retractable castors)
- Screw in or unscrew the feet to adjust the height to suit the shape of the floor (Diagram D13)
- Set the machine back on its feet and check that it is stable.

• TEXTILE MAINTENANCE CODES

– **Washing** : Never exceed the indicated temperatures

– **Use of cold diluted bleach possible:**

– **Iron:** Low Medium High

– **Dry clean:** mineral spirit perchlorethylene
all solvents

– **NB: A crossed-out code indicates that it is forbidden**

• LOADING YOUR WASHING

Perform these actions in the following order:

• Open the machine

- Check that the Programme selector is correctly positioned on "0".
- Lift the opening handle on the front of the machine. The lid will open.
- Open the drum by pressing the button on the front door.

• Insert your washing

For optimum washing performance, place your washing, preferably sorted and folded, in the drum, distributing it evenly without heaping it up. Mix large and small items to obtain an optimum, well-balanced spin.

• Close the drum

Ensure that the drum is correctly closed.

⚠ Important:

Check that the three hooks and the border of the button are fully visible.

• LOADING THE WASHING PRODUCTS

⚠ Important: (Diagram D14)

– The "WASH" container may contain powder or liquid but liquid detergent should not be used for programmes WITH Prewash and/or WITH "Delayed Start" (depending on the model).

- Concentrated softener should be diluted with warm water.
- Concentrated bleach must be diluted.
- To fill the product containers correctly, place the lid fully open.
- Do not exceed the **MAX** level.

• Dispensing the detergent

The amount of detergent to be used depends on the hardness of the water, the extent to which your washing is soiled and the amount of washing to be washed.

Please refer to the dosing instructions on your pack of detergent.

Warning: in most cases, the detergent manufacturer's recommendations apply to the drum filled to the maximum. Adjust the dosage correctly to the weight of the washing you have placed in the machine.

These recommendations will help you to avoid using too much detergent, which causes foam to be produced. Too much foam can reduce your machine's performance and increase the length of the washing cycle and the consumption of water.

• Detergents for woollens and delicate fabrics

You are recommended to use an appropriate detergent for washing these fabrics (avoid placing such detergents directly on the drum because they have an aggressive action on the metal).

• Before your first wash

Before making your first wash, we recommend that you carry out a "COTTON 90 wash without pre-wash" and with no washing in the drum, using a 1/2 measure of your usual detergent in order to eliminate any residues from manufacturing that may remain in your machine.

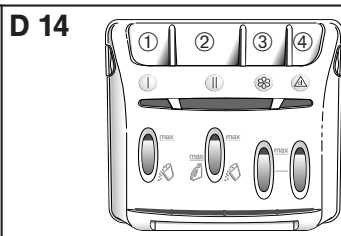
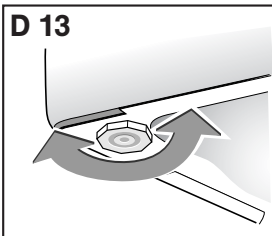

- ① | Pre-wash container (powder)
- ② || Wash container (powder or liquid)
- ③ Softener
- ④ Bleach

: POWDERED DETERGENT

: LIQUID DETERGENT

• DESCRIPTION OF THE CONTROL PANEL

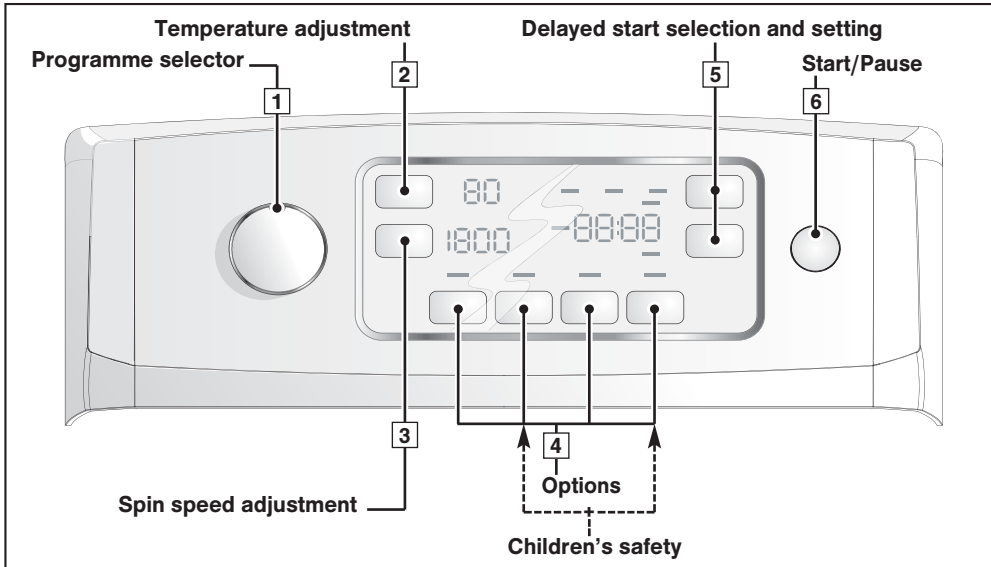

Information:
All the buttons are touch-sensitive and therefore do not push in. In any case, the "Start/Pause" button cannot cancel a programme.

Important:
Before starting your machine, check that the power cable is plugged in and the water tap is open. Also ensure that the drum doors are closed correctly and the machine's lid is shut.

During the "End of Cycle" phase, when "StOP" is lit, any action on one of the controls (the selector or the buttons) returns you to "Programming" mode. As a safety measure, when the cycle is over, we recommend that you unplug the power cable and turn off the water tap.

• CONFIRM, CANCELLING, PAUSE

• Confirm your choice:

– The "Start/Pause" button [6] is used to confirm the program you have chosen.

NB: After programming a delayed start wash cycle, there is no need to press "Start/Pause". The selection will be registered after a few seconds.

• Cancelling:

– You can cancel your selections at any time by turning the selector [1] to "0".

This operation can be performed during programming, during the waiting period before the cycle actually starts and throughout the whole washing cycle. It also cancels the "Children's Safety" system.

• Pause:

– You can also temporarily stop the cycle by briefly pressing the button "Start/Pause" [6].

Important:
This action is not possible during the spin cycle.

For more details on this function, please refer to the section «PROGRAMMING : Adding or removing an item...».

• ACTIVE MEMORY FUNCTION

Your washing machine memorises your washing habits. Every time you start a programme, it records the temperature, the speed and the options you generally use and suggests these when you switch on.

Important:
When you start your machine for the first time, it proposes the manufacturer's recommended programme but it will learn your habits after a few cycles.

• PROGRAMMING

• Programming a washing cycle:

– Turn the selector [1] to choose the most suitable programme for the type of fabric to be washed.

NB: Turning the selector to any position other than "0" provides power to the machine.

– If you wish, the suggested wash temperature can be changed using button [2].

NB: For a cold wash, change the temperature to "0".

– You can also use button [3] to:
- modify the suggested spin speed.

- programme drainage for the end of the cycle.
The cycle will finish with a gentle spin at 110 rpm.

- or even select a full drum stop.
Your machine will stop with the tub full of water before the final spin.

– Use the buttons [4] to select any options you wish.

Display

The machine displays the most suitable temperature and spin speed for the programme selected as well as the length of this programme.



Light(s) for the option(s) selected

Information:
For each of the selections above, the machine will only allow you to select values or options that are compatible with the programme selected.

• PROGRAMMING

• Programming a washing cycle (continued) :

– Select immediate start by pressing "Start/Pause" **6** ...

Display

The phase of the cycle the machine is in is displayed throughout the cycle...



... along with the remaining cycle time.

Remaining time
1:20

– ... or select a start delayed using buttons **5** (for how to do this, see the section "DETAILS OF THE OPTIONS • Delayed start").



An animation (four small elements turning on themselves) shows the waiting period before the start of the cycle.

• Adding or removing an item during the cycle (impossible during spin):

– Press the "Start/Pause" button **6** to interrupt the cycle.

– Add or remove the items of laundry

The time the lid remains locked depends on the temperature inside the machine and, for safety reasons, may take several minutes if you are interrupting a cycle at more than 40 °C.

– Press the "Start/Pause" button **6** to restart the cycle.

NB: If you have selected a delayed start, you can access the drum instantly at any time in the period before the washing cycle starts without having to interrupt and restart the cycle.

Countdown of the time is stopped and cycle progress and "Remaining time" lights flashing alternately.



Resumption of the countdown and lights stop flashing and remain lit.



• Cancelling while programming, washing or during a pause:

– Set the selector **1** to the "0" position.

NB :

- In all cases, after cancelling you must reprogramme everything from the start.

- If you have cancelled during the washing phase, remember to empty the water, if necessary. To do this, select a "Spin" programme by setting the speed to "1:00".

All displays are off.

• End of the cycle:

NB: After spinning, your machine automatically position the drum opening at the top to provide easy access to the washing. This operation lasts at most 3 minutes.

– The machine then displays "STOP", indicating that the cycle has finished.

Set the selector **1** to the "0" position.

You can now open the lid and remove your washing.

STOP
Delayed start

• Maintaining your machine's performance (Maintaining the pump filter):

You must clean the drain pump filter regularly (for how to do this, see the section "CLEANING THE PUMP FILTER").

Important :

Your machine's performance can be affected if you do not clean the pump filter regularly.

For more details on the various functions, please refer to the sections "DETAILS OF THE PROGRAMMES" and "DETAILS OF THE OPTIONS".















Information:

After a power failure, when the power is restored, the washing cycle automatically resumes at the point where it was interrupted.

• SOME EXAMPLES OF PROGRAMMES

To select the most suitable programme for your type of washing, follow the instructions on the labels that most textiles bear.

Programmes table									
Type of textile		Temperature (°C)	Maximum weight of dry clothes	Prewash	Save time	Rinse plus	Easy ironing	Drip-dry	Full drum stop
	COTTON	0 - 90°	6,0 kg	●	●	●	●	●	●
	MIXED	0 - 60°	2,5 kg	●	●	●	●	●	●
	DELICATES	0 - 40°	1,5 kg			●		●	●
	WOOL	0 - 40°	1,5 kg			●		●	●
Special programmes									
	OptiA 45 min	0 - 40°	3,0 kg			●		●	●
	Flash 30 min	0 - 40°	2,5 kg					●	●
	Hand wash	0°	1,0 kg			●		●	●
Additional programmes									
	Rinsing	-	-					●	●
	Spinning	-	-					●	

● : These functions can be used alone or in combinations: **no illogical combinations can be made.**

• TEST PROGRAMMES ACCORDING TO DELEGATED REGULATION (EU) No. 1061/2010

- Standard cotton programme at 60°C : Cotton - 60°C - no option - max spin.
- Standard cotton programme at 40°C : Cotton - 40°C - no option - max spin.

• CHILDREN'S SAFETY SYSTEM

- To protect your programming, activate the "Children's Safety" system by simultaneously pressing the 2nd and 4th option buttons **4**.

When the safety lock is on, the light by the  symbol is lit.

- To deactivate the "Children's Safety" system, press both buttons again simultaneously.

NB: You can activate or deactivate the "Children's Safety" system at any time. Of course, we recommend that you only activate it after you have programmed and started the cycle.

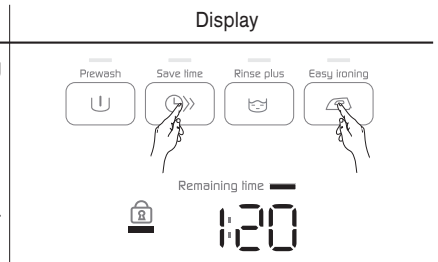

• DETAILS OF THE PROGRAMMES

The main programmes provided by the machine are as follows:

• OptiA 45 min

This 40°C cycle washes a normal 3 kg load of cotton and mixed fabrics in 45 minutes, ensuring perfect washing results and maximum energy saving.

• Cotton 

If your washing comprises hard-wearing white or coloured COTTONS.

Important: When washing coloureds do not exceed a maximum temperature of 60°C.

NB : During the first few minutes of the programme, your machine automatically evaluates the washing load you have introduced and adapts the water consumption and the length of the programme accordingly to provide a perfect wash.

• Mixed 

If your washing comprises of DELICATE COLOURS, HARD-WEARING SYNTHETICS or MIXED FIBRES.

• Delicates 

If your washing comprises NETTING, DELICATE FABRICS or FRAGILE TEXTILES

NB : A programme with agitation and spin phases specially adapted to these types of fabrics

• Wool 

If your washing comprises WOOLLENS or MACHINE-WASHABLE WOOLLENS"

NB : A programme with agitation and spin phases specially adapted to these types of fabrics

• Hand wash 

If your washing comprises SILK or PARTICULARLY DELICATE FABRICS **NB :** A programme with a very gentle mechanical action and no intermediate spins between rinses.

The cycle ends with a very gentle, progressive spin restricted to 600 rpm.

• DETAILS OF THE PROGRAMMES (continued)

• Rinsing

A separate rinse followed by a choice of:

- Either spin and drain
- Or drain only ("Drip-dry" option)
- Or a stop with the drum full of water.

• Spinning

This allows a separate spin and drain.

Important:
In the case of "Rinse only" followed by a spin or "Spin only", ensure that you select a suitable spin speed for the type of washing in the machine.

• Flash 30 min

This programme enables you to refresh a small load of 2.5 kg of lightly soiled washing composed of WHITES, COTTONS, COLOURED or HARD-WEARING SYNTHETICS.

The cycle time is restricted to around 30 minutes

In this programme, the washing temperature is automatically programmed at 40°C.

Important:
For this programme, the doses of detergent should be reduced by half.

• DETAILS OF THE OPTIONS

• Prewash

Specially designed for heavily soiled washing (mud, blood, etc.).

A specific initial agitation in cold water precedes a phase of heating to 30°C.

This agitation phase in cold water enables the particles soiling the washing to be removed before the water is heated.

Important:
Detergent must be placed in the "I" container in the products box (see the section "LOADING THE WASHING PRODUCTS").

• Save time

Allows for a reduction in the cycle time according to 2 levels that can be accessed by pressing on the button several times. Level 1, reduces the average time by 20%. Level 2 reduces the average time by 40% for laundry that is only lightly soiled.

• Rinse plus

"Especially for sensitive and allergic skin": adds an extra rinse to the washing cycle.

• Easy ironing

This option washes your laundry more gently, but with an identical washing performance. The spin speed is slower so that your laundry creases less.

• Drip dry

This function, for very delicate linen, enables you to remove spinning and to pass directly to the draining of the washing machine.

• Full drum stop (L D)

This function enables you to remove the washing from your machine before the spin phase or to delay this phase with you washing remaining in water to prevent creasing.

NB: When the machine stops with the drum full of water, the "Spin" cycle progress light  flashes and the remaining time displayed is "00:00".

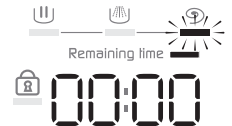

Then:

– **Either you want to drain after spinning.**

In this case, use the button  [3] to choose a suitable spin speed for your type of washing.

The programme will end automatically.

– **Or you just want to drain.**

In this case, use the button [3] to select the "Drip Dry" function (spin speed "I D").

• Delayed start

You can delay the start of your programme to use off-peak electricity or to avoid your washing standing in the drum for too long at the end of the cycle.

To do this, press the button "+" [5].

By repeatedly pressing the (+) button, select the time by which you wish to delay the cycle start (in increments of 1 hour).

NB:

- The "-" button can be used to go backwards.

- The time remaining before the cycle start is counted down by the hour until 1 hour and then by minutes from 59 minutes to 1 minute.

Information:
Throughout the whole waiting period, four elements light up in succession



At the end of the waiting period, the programme starts and the machine counts down the time remaining before the end of the cycle.

• MODIFYING A WASHING PROGRAMME

• During programming:

Anything can be changed before the "Start/Pause" button **6** is pressed.

• After the cycle has started:

If you want to change the type of fabric (e.g. from "COTTON" to "MIXED") after you have pressed the "Start/Pause" button **6**, you have to cancel the current programme. To do this, turn the selector **1** to "0".

Then programme your new selection remembering to confirm it by pressing the "Start/Pause" button **6**.

NB: If you change the programme without first cancelling it, the machine displays:

This indicates that the new selection has not been registered.

On the other hand, the current cycle is not cancelled and if you turn the selector switch **1** back to its original position, this cycle will resume.



• Throughout the cycle:

The following changes are possible without pressing the "Start/Pause" button **6**.

- You can change the temperature for the same type of textile.

NB: If the temperature achieved by the washing cycle is higher than your new selection, heating the water stops immediately and the cycle continues.

- You can alter the spin speed throughout the cycle.

- You can select "Drip Dry" and "Full drum stop" throughout the washing phase.

- You can activate the "Rinse plus" (☹) option until rinsing starts (until the cycle progress light "☹" illuminates).

- You can deactivate all the options throughout the cycle provided that their action has not already finished.

• During the period before the cycle actually starts (if you have chosen to delay the time your washing starts):

- Any kind of programme modification is accepted during a delayed start's waiting period.

- You can alter the length of a delayed start throughout the waiting period before the cycle effectively starts. To do this, press the (+) or (-) buttons **5** to select a new value.

NB:

- During this period, selecting a new time cancels out the previous selection. The new period selected is accepted based on the last selection made.

- If, during this time, you wish to completely cancel the "delayed start", press either the (+) button or the (-) button until the "Delayed start" light goes out and the "Remaining time" light comes on.

Then briefly press "Start/Pause" **6**.

The cycle will start immediately.

• When the cycle is over:

When the machine shows "StOP", you can programme a new cycle without having to reset the selector **1** to the "0" position.

For this, all you have to do is turn the selector or press one of the buttons **2**, **3** or **4**.

The machine displays the time of the previously selected programme.

The machine is then ready to be reprogrammed.

• AUTOMATIC SAFETY SYSTEMS

• Lid opening safety system:

As soon as washing commences, the lid on your machine is locked.

When the cycle is finished or when the machine has stopped with the drum full of water, the lid unlocks.

If you have selected a delayed wash, the lid remains unlocked throughout the waiting period until the cycle actually starts.

If you wish to open the lid during the cycle, press button "Start/Pause" **6** briefly and wait 1-2 minutes for the safety system to unlock the lid.



Important:

Depending on when you wish to open the lid during the cycle, this time delay may be a little longer because a cooling down period may also have to be included.

In fact, to avoid your being severely burnt, the lid safety system will not open during the cycle unless the temperature inside the machine is below a certain threshold.

• Water safety system:

During operation, constant control of the water prevents any overflows.

• Spin safety system:

Your washing machine is fitted with a safety system that restricts the spin when poor load distribution is detected.

In this case, your washing may be insufficiently spun. Redistribute your washing in the drum and programme a new spin.

• Anti-foam system:

Your machine can detect when too much foam is being produced during spinning.

At such times, spinning stops and the machine drains.

The cycle then restarts, adapting the spin rates and possibly adding an extra rinse.

• CLEANING THE PUMP FILTER

This filter collects the small objects you may have inadvertently left in your clothes and prevents them from disrupting the pump's operation. To clean the filter, proceed as follows:

- Open the drum doors. At the back of the drum, you will see a plastic component **A** (Diagram D15)
- Release this (Diagram D16).

To do this:

- Insert a rod (a pencil or a screwdriver, for example) into the hole in the component **A**
- Press down vertically with the rod, while pushing the component **A** over to the right until it is released from its housing
- Remove the component **A**
- Turn the drum slightly towards the front of the machine, with the doors open (Diagram D17)

You can access the pump filter **B** through the openings freed by removing the plastic component **A**

- Remove the filter from its housing (Diagram D17)
- Remove the various objects it may have in it
- Rinse it under the tap (Diagram D18)
- Re-insert it, pushing it firmly into its housing after checking that the housing is clean
- Re-insert the plastic component **A**, ensuring that it is positioned correctly in the openings at the bottom of the drum and pushing it to the left until it is fully engaged (Diagram D19).

• CLEANING THE MACHINE

⚠ Important :
To clean the casing, the control panel and all the plastic parts in general, use a sponge or a soft cloth dampened only with water and liquid soap.

In all cases, do not use:

- Abrasive powders
- Metal or plastic sponges
- Alcohol-based products (alcohol, thinners, etc.)

• CARE OF THE INTERNAL COMPONENTS

To ensure better hygiene, we recommend that you:

- Leave the lid open for a short time after washing.
- Clean the plastic and rubber access components to the tank approximately once a month using a slightly chlorinated product. Run a rinsing cycle to remove any residue of this product.
- Run a washing cycle at 90°C at least once a month.

• CLEANING THE PRODUCTS' BOX

Clean the products' box regularly.

To do this:

- Press the bosses **C** on each side of the box simultaneously to extract it from its housing (Diagram D20).
- Remove the siphons **D** from the rear of the box **E** and separate the box from its front cover **F** (Diagram D21)
- Rinse everything under the tap (taking care to empty any excess water remaining inside the box).
- Refit all the box' components, ensuring that the box section itself is properly clipped into the cover and then re-insert the complete assembly into its location under the machine's lid.

• PERIODIC CHECKS

To avoid any water damage, we recommend that you regularly check the condition of the water and drain hoses. If you notice the slightest cracking, do not hesitate to replace the hoses with identical ones available from the manufacturer or his After-Sales Service. For how to replace the water supply hose, please refer to the section "CONNECTING TO THE COLD WATER SUPPLY"

• REPLACING THE POWER SUPPLY CABLE

⚡ Warning:
For your safety, the power cable and, depending on the model, the complete electric box and its associated cable must only be replaced by the manufacturer's After-Sales Service or a qualified electrician.

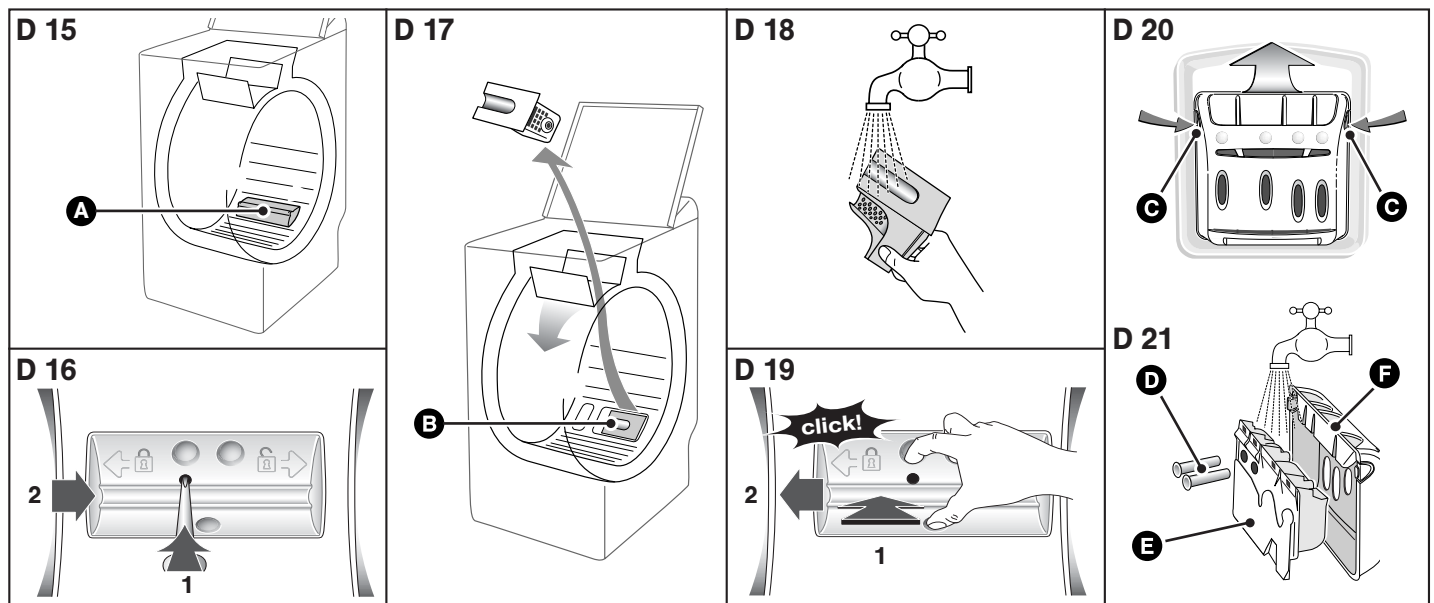

• **INCIDENTS THAT MAY OCCUR**

• **The cycle does not start**

- You have not pressed the "Start/Pause" button
- There is no power to the machine:
 - Check that the plug is correctly in the socket
 - Check the circuit breaker and the fuses.
- The water tap is closed
- The machine's lid is not closed properly

• **A puddle of water forms around the machine**

 **Warning:**
First of all remove the plug and the fuse and shut off the water supply tap.

While the machine is operating, the permanent level control prevents the water from overflowing. If, despite this, water comes out of your machine, it may be that:

- The drain hook is wrongly positioned in the drain pipe.
- The water supply hose is not sealed tightly at the machine or tap end:
 - Check that the seals are in place and the connections are tight.

• **Heavy vibration during spin**

- All the transport materials have not been removed correctly from the machine:
 - Check that all the transport wedges have been removed (see "REMOVING THE TRANSPORT CLAMPS").
- The floor is not level.
- Your machine is resting on its two "front" castors (depending on the model):
 - Reset your machine on its feet by pushing the castor engagement lever to the right.

• **The washing is not spun or not spun enough**

- You have selected a programme with no spin, for example "Drip-dry"
- The spin safety system has detected poor distribution of the washing in the drum:
 - Untangle the washing and programme a new spin.

• **The machine does not drain**

- You have programmed "Full drum stop"
- The pump filter is blocked:
 - Clean it (see "CLEANING THE PUMP FILTER" for the relevant procedure)
- The drain hose is kinked or squashed

• **The lid does not open**

- The programme has not yet finished
- The lid remains locked throughout the programme.

• **The drum doors open very slowly**
 (On machines fitted with gently opening doors)

- Your machine has not operated for a long time
- It is located in too cold a position.
- Detergent residue (powder) is blocking the hinges
 - In all cases, everything returns to normal after the doors have opened initially

 **Important :**
As a general rule, whatever the anomaly detected, you should stop the machine, unplug the power cable and shut off the water tap

• **NOTE ON OPERATION - THIS IS NOT AN INCIDENT:**

• **The programme time decreases or increases during the wash**



This is not a fault. The length of time displayed at the start of the programme is updated according to the load in the machine (automatic weighing). This guarantees perfect washing results and water and energy consumption appropriate to the load. **This is normal.** The spin safety and anti-foam systems may extend the initial programme time displayed.

• **MESSAGES SHOWN ON THE DISPLAY**

• **Incidents indicated, which you can rectify yourself**

In this section, we explain how you can rectify these incidents very easily yourself.

Your machine automatically detects some operating incidents and indicates these by particular messages shown on the screen.

Messages	Causes / Remedies
	The water tap is closed. Check that the water tap is open and then press the "Start/Pause" button again to restart the cycle. This incident may also be caused by the drain hose being poorly connected (see the section "DRAINING AWAY THE WASTE WATER").
	The pump filter is clogged. Clean the pump filter (for how to do this, see the section "CLEANING THE PUMP FILTER") and then press the "Start/Pause" button again to restart the cycle. Also check the drain hose's position in the drain: the connection must not be airtight (see the section "DRAINING AWAY THE WASTE WATER").
	Lid not closed properly. Check that the lid is closed and then press the "Start/Pause" button again to restart the cycle. Drum blocked. Check that a small item of laundry (e.g. a handkerchief or a sock, etc.) has not slipped down between the tub and the drum and is stopping the drum from turning. To access the bottom of the tub, please refer to the section "CLEANING THE PUMP FILTER".

NB:
 If you have experienced an operating incident which is not mentioned above, we recommend proceeding as follows before calling a breakdown engineer:

- Set the Programme selector to the "0" position and remove the electrical plug for at least 10 seconds
 - Reconnect the plug and restart a washing cycle.
- If the fault persists, call your breakdown engineer .

 **Important:**
Do not restart a washing cycle if the drum remains locked or if you notice water around your machine or if you notice a burning smell.

• **AFTER-SALES SERVICE :**

Possible maintenance on your washing machine should be undertaken by :

- either your dealer,
- or another qualified mechanic who is an authorized agent for the brand appliances.

When making an appointment, state the complete reference of your equipment (model, type and serial number). This information appears on the manufacturer's nameplate attached to the rear of the equipment.

To keep your appliance in good working order, we recommend that you use **Clearit** household products.



Professional expertise for the general public

Clearit offers you professional products and adapted solutions for the daily upkeep of your household and kitchen appliances. You may find them in conventional retail outlets, along with a complete line of by-products and consumables.