

Pinguino 25 single

caleido®
design radiators

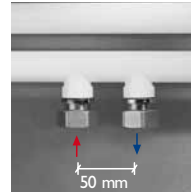

Interasse 50 mm **a richiesta.**
50 mm centre distance **on request.**
Entraxe 50 mm **sur demande.**
Achsstabnd 50 mm **auf Anfrage.**
Distancia entre centros 50 mm **bajo pedido.**

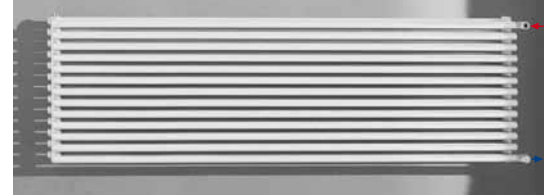

Allacciamento laterale destro oppure sinistro **a richiesta,**
ideale per sostituire un vecchio radiatore.

Lateral connection right or left **on request,**
ideal when replacing an old radiator.

Raccordement latéral droite ou gauche **sur demande,**
idéal pour remplacer un radiateur précédent.

Seitlicher Anschluss links oder rechts **auf Anfrage,**
ideal zum Austauschen eines alten Heizkörpers.

Conexión lateral derecha o izquierda **bajo pedido,**
ideal para reemplazar un radiador antiguo.

· I radiatori sono completi di kit di fissaggio a parete e valvola di sfianto.
La versione cromata NON è disponibile.

~ Pressione di collaudo: 10,5 bar ~ Pressione di esercizio: 7 bar

· The radiators are equipped with a kit for fixing them to the wall and with an exhaust valve.

Chromate radiators NOT available.

~ Testing pressure: 10,5 bar ~ Working pressure: 7 bar

· Les radiateurs sont munis d'un kit de fixation murale et d'une soupape de décompression.

La version chromée N'est PAS disponible.

~ Pression d'essai: 10,5 bars ~ Pression d'exercice: 7 bars

· Die Heizkörper sind mit Wandbefestigungsset und Luftventil ausgerüstet.

Die verchromte Version ist nicht verfügbar.

~ Prüfungsdruck: 10,5 bar ~ Betriebsdruck: 7 bar

· Los radiadores están provistos de kit de fijación a la pared y de válvula de desahogo.

La versión cromada NO está disponible.

~ Presión de ensayo: 10,5 bar ~ Presión de trabajo: 7 bar

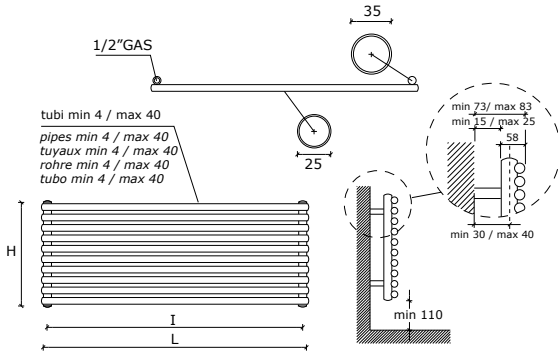

interasse dal centro foro al muro min 30 / max 40 mm
distance between hole center and wall min 30 / max 40 mm
distance du centre du trou au mur min 30 / max 40 mm
Abstand zwischen Lochmitte und Wand min 30 / max 40 mm
distancia entre el centro del agujero y el muro min 30 / max 40 mm

Materiale: acciaio al carbonio
Material: carbon-steel
Matière: Acier au charbon
Stoff: Kohlenstoffstahl
Material: Acero de carbono

Esempio per la compilazione del codice da indicare sull'ordine:

Example for the filling in of the code to be indicated in the order:

Exemple pour la compilation du code à indiquer dans la commande:

Beispiel für die Zusammenstellung von in der Bestellung anzugeben Kode:

Ejemplo para la cumplimentación del código a indicar en el pedido:

P	04	S	...	P04S810
↓	↓	↓	↓	↓
Pinguino	N° elementi	single	altezza radiatore	esempio di codice completo: Radiatore Pinguino 4 elementi single altezza 810
Pinguino	N° of elements	single	height of radiator	example of complete code: Pinguino radiator 4 elements single height 810
Pinguino	Nombre éléments	single	hauteur radiateur	Exemple de code complet Radiateur Pinguino 4 éléments single hauteur 810
Pinguino	Anzahl von Elementen	single	Höhe von Heizkörper	Beispiel von kompletten Kode- Heizkörper Pinguino 4 Elemente Single Höhe 810
Pinguino	N° de elementos	single	altura del radiador	Ejemplo de código completo Radiador Pinguino 4 elementos single altura 810

Pinguino 25 double

caleido®
design radiators

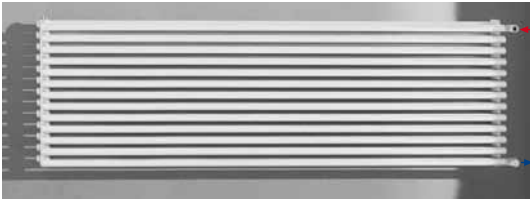

Allacciamento laterale destro oppure sinistro **a richiesta**, ideale per sostituire un vecchio radiatore.

Lateral connection right or left **on request**, ideal when replacing an old radiator.

Raccordement latéral droite ou gauche **sur demande**, idéal pour remplacer un radiateur précédent.

Seitlicher Anschluss links oder rechts **auf Anfrage**, ideal zum Austauschen eines alten Heizkörpers.

Conexión lateral derecha o izquierda **bajo pedido**, ideal para reemplazar un radiador antiguo.

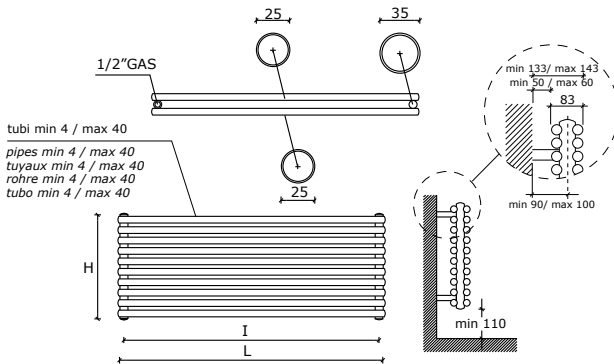

interasse dal centro foro al muro min 90 / max 100 mm
distance between hole center and wall min 90 / max 100 mm
distance du centre du trou au mur min 90 / max 100 mm
Abstand zwischen Lochmitte und Wand min 90 / max 100 mm
distancia entre el centro del agujero y el muro min 90 / máx 100 mm

Materiale: acciaio al carbonio
Material: carbon-steel
Matière: Acier au charbon
Stoff: Kohlenstoffstahl
Material: Acero de carbono

· I radiatori sono completi di kit di fissaggio a parete e valvola di sfianto. La versione cromata NON è disponibile.
~ Pressione di collaudo: 10,5 bar ~ Pressione di esercizio: 7 bar

· The radiators are equipped with a kit for fixing them to the wall and with an exhaust valve.
Chromate radiators NOT available.
~ Testing pressure: 10,5 bar ~ Working pressure: 7 bar

· Les radiateurs sont munis d'un kit de fixation murale et d'une soupape de décompression.
La version chromée N'est PAS disponible.
~ Pression d'essai: 10,5 bars ~ Pression d'exercice: 7 bars

· Die Heizkörper sind mit Wandbefestigungsset und Luftventil ausgerüstet.
Die verchromte Version ist nicht verfügbar.
~ Prüfungsdruck: 10,5 bar ~ Betriebsdruck: 7 bar

· Los radiadores están provistos de kit de fijación a la pared y de válvula de desahogo.
La versión cromada NO está disponible.
~ Presión de ensayo: 10,5 bar ~ Presión de trabajo: 7 bar

Esempio per la compilazione del codice da indicare sull'ordine:

Example for the filling in of the code to be indicated in the order:

Exemple pour la compilation du code à indiquer dans la commande:

Beispiel für die Zusammenstellung von in der Bestellung anzugeben Kode:

Ejemplo para la cumplimentación del código a indicar en el pedido:

P	04	D	...	P04D810
Pinguino	N° elementi	double	larghezza radiatore	esempio di codice completo: Radiatore Pinguino 4 elementi double larghezza 810
Pinguino	N° of elements	double	width of radiator	example of complete code: Pinguino radiator 4 elements double width 810
Pinguino	Nombre éléments	double	largeur radiateur	Exemple de code complet Radiateur Pinguino 4 éléments double largeur 810
Pinguino	Anzahl von Elementen	double	Breite von Heizkörper	Beispiel von kompletten Kode- Heizkörper Pinguino 4 Elemente Double Breite 810
Pinguino	N° de elementos	double	longitud del radiador	Ejemplo de código completo Radiador Pinguino 4 elementos double longitud 810

Pinguino 25 triple

caleido®
design radiators

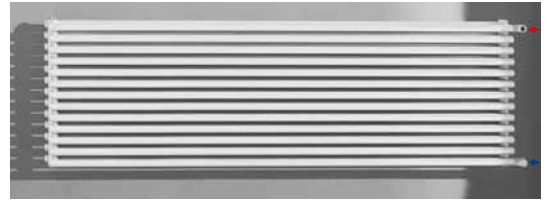

Allacciamento laterale destro oppure sinistro **a richiesta**, ideale per sostituire un vecchio radiatore.

Lateral connection right or left **on request**, ideal when replacing an old radiator.

Raccordement latéral droite ou gauche **sur demande**, idéal pour remplacer un radiateur précédent.

Seitlicher Anschluss links oder rechts **auf Anfrage**, ideal zum Austauschen eines alten Heizkörpers.

Conexión lateral derecha o izquierda **bajo pedido**, ideal para reemplazar un radiador antiguo.

· I radiatori sono completi di kit di fissaggio a parete e valvola di sfriato.

~ Pressione di collaudo: 10,5 bar ~ Pressione di esercizio: 7 bar

· La versione cromata NON è disponibile.

* I watt hanno valori provvisori in attesa di certificazione $\Delta t50$.

· The radiators are equipped with a kit for fixing them to the wall and with an exhaust valve.

~ Testing pressure: 10,5 bar ~ Working pressure: 7 bar

- Chromate radiators NOT available.

* The watt values are not definitive awaiting for $\Delta t50$ certification.

· Les radiateurs sont munis d'un kit de fixation murale et d'une soupape de décompression.

~ Pression d'essai: 10,5 bars ~ Pression d'exercice: 7 bars

· La version chromée N'est PAS disponible.

* Le nombre de Watts est une valeur indiquée à titre provisoire dans l'attente de la certification $\Delta t50$.

· Die Heizkörper sind mit Wandbefestigungsset und Luftventil ausgerüstet.

~ Prüfungsdruck: 10,5 bar ~ Betriebsdruck: 7 bar

· Die verchromte Version ist nicht verfügbar.

* Die Wattwerte sind noch provisorisch in Erwartung von $\Delta t50$ Zertifizierung.

· Los radiadores están provistos de kit de fijación a la pared y de válvula de desahogo.

~ Presión de ensayo: 10,5 bar ~ Presión de trabajo: 7 bar

· La versión cromada NO está disponible.

* Los Vatios tienen valores provisionales en espera de la certificación $\Delta t50$.

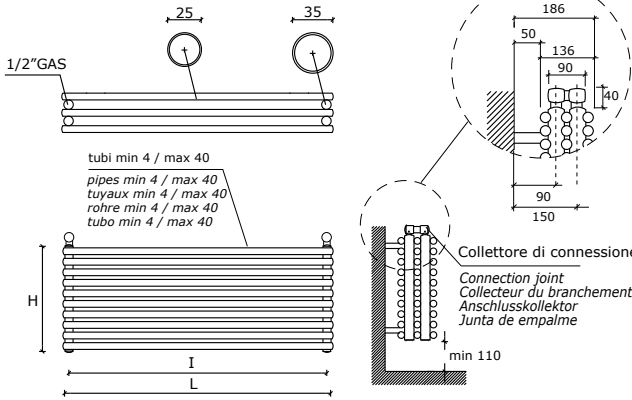

Interasse dal centro foro al muro: ↑ mandata 90 mm - ↓ ritorno 150 mm
 OPPURE ↑ mandata 150 mm - ↓ ritorno 90 mm
 Distance between hole centre and wall: ↑ inlet 90 mm - ↓ outlet 150 mm
 OR ↑ inlet 150 mm - ↓ outlet 90 mm
 distance du centre du trou au mur: ↑ entrée 90 mm - ↓ sortie 150 mm
 OU ↑ entrée 150 mm - ↓ sortie 90 mm
 Abstand zwischen Lochmitte und Wand: ↑ Vorlauf 90 mm - ↓ Rücklauf 150 mm
 ODER ↑ Vorlauf 150 mm - ↓ Rücklauf 90 mm
 distancia entre el centro del agujero y el muro: ↑ entrada 90 mm - ↓ salida 150 mm
 O ↑ entrada 150 mm - ↓ salida 90 mm

Materiale: acciaio al carbonio
 Material: carbon-steel
 Matière: Acier au charbon
 Stoff: Kohlenstoffstahl
 Material: Acero de carbono

Esempio per la compilazione del codice da indicare sull'ordine:
 Example for the filling in of the code to be indicated in the order:
 Exemple pour la compilation du code à indiquer dans la commande:
 Beispiel für die Zusammenstellung von in der Bestellung anzugeben Kode:
 Ejemplo para la cumplimentación del código a indicar en el pedido:

P	04	T	...	P04T810
Pinguino	N° elementi	triple	altezza radiatore	esempio di codice completo: Radiatore Pinguino 4 elementi triple altezza 810
Pinguino	N° of elements	triple	height of radiator	example of complete code: Pinguino radiator 4 elements triple height 810
Pinguino	Nombre éléments	triple	hauteur radiateur	Exemple de code complet Radiateur Pinguino 4 éléments triple hauteur 810
Pinguino	Anzahl von Elementen	triple	Höhe von Heizkörper	Beispiel von kompletten Kode- Heizkörper Pinguino 4 Elemente Triple Höhe 810
Pinguino	N° de elementos	triple	altura del radiador	Ejemplo de código completo Radiador Pinguino 4 elementos triple altura 810

COLORI . COLOURS . COULEURS . FARBEN . COLORES

STANDARD



9010 RAL bianco puro opaco / pure white matt / blanc pur mat / mattes reines Weiß / Blanco puro mate
di serie Fine Design e Metacrilati / Standard for Fine Design and Metacrilati / de série pour Fine Design et Metacrilati
serienmäßig Fine Design und Metacrilati / de serie por Fine Design y Metacrilati

GRUPPO A - GROUP A - GROUPE A - GRUPPE A - GRUPO A

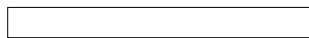

bianco B7 ruvido / rough white B7 / blanc B7 rugueux / grobes Weiß B7 / Blanco B7 rugoso

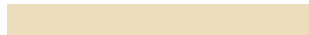

9001 RAL pergamon bianco / pergamon white / blanc pergamon / Pergamon-Weiß / Blanco pergamon

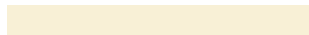

1013 RAL bianco perla opaco / pearl white matt / blanc perle mat / mattes Perlweiß / Blanco perla mate



1015 RAL avorio chiaro opaco / light ivory matt / ivoire clair mat / mattes helles Elfenbein / Marfil claro mate



1014 RAL avorio opaco / ivory matt / ivoire mat / mattes Eifenbein / Marfil mate



1001 RAL beige opaco / beige matt / blanc mat / mattes Beige / Beige mate



3000 RAL rosso / red / rouge / rot / Rojo



3002 RAL rosso carminio opaco / red chrome matt / rouge carmin mat / mattes Karminrot / Rojo carmin mate



3003 RAL rosso rubino opaco / ruby red matt / rouge rubis mat / mattes Rubinrot / Rojo rubí mate



3004 RAL rosso porpora opaco / purple red matt / rouge pourpre mat / mattes Purpurrot / Rojo púrpura mate



1021 RAL giallo / yellow / jaune / gelb / Amarillo



6019 RAL verde / green / vert / grün / Verde



6016 RAL verde / green / vert / grün / Verde



calypso



5014 RAL colomba opaco / blue pigeon matt / blue pigeon mat / mattes taubenblau / Azul colomblano



5015 RAL blu / blue / bleu / blau / Azul celeste



azzurro toscana / light blue Tuscany sky / bleu ciel Toscane / toscanablau / Azul celeste Toscana



royal blue semiopaco / royal blue half-matt / royal blue semi-mat / halbmattes königsblau / Azul real semimate



manhattan



7011 RAL grigio ferro opaco / iron grey matt / gris fer mat / mattes Eisengrau / Gris hierro mate



7015 RAL grigio ardesia opaco / slate grey matt / gris ardoise mat / mattes Schiefergrau / Gris pizarra mate



7016 RAL grigio antracite opaco / anthracite grey matt / gris anthracite mat / mattes Anthrazitgrau / Gris antracita mate



7021 RAL grigio nerastro opaco / blackish grey matt / gris foncé mat / mattes Schwarzgrau / Gris negruzco mate



nero N4 ruvido / rough black N4 / noir N4 rugueux / grobes Schwarz N4 / Negro N4 rugoso



9005 RAL nero intenso / deep black / noir profond / sattes Schwarz / Negro intenso



9011 RAL nero grafite / black lead / noir graphite / Graphitschwarz / Negro grafito

GRUPPO B - GROUP B - GROUPE B - GRUPPE B - GRUPO B



4005 RAL lilla ruvido / lilac rough / lilas rugueux / Lila groß/ lila rugoso



met iron BD RAG ruvido / met iron BD RAG rough / fer métallisé BD RAG rugueux
met iron BD RAG grob / hierro metalizado BD RAG rugoso

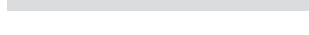

met grigio 3 RAG ruvido opaco / met grey 3 RAG rough matt / gris métallisé 3RAG rugueux mat
met grau 3 RAG grob / gris metalizado BD RAG rugoso mate

GRUPPO C - GROUP C - GROUPE C - GRUPPE C - GRUPO C



marrone satinato / satined brown / marron satiné / Braun satiniert / marrón satinado



1036 RAL oro perla / pearl gold / or perle / perle gold / oro perlado



verniciato satinato / painted satined / peint satiné / lackiert satiniert / pintado satinado