

# Zigolo 25 single

caleido®  
design radiators

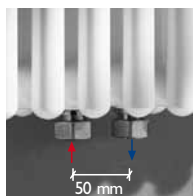

Interasse 50 mm **a richiesta.**  
50 mm centre distance **on request.**  
Entraxe 50 mm **sur demande.**  
Achsabstand 50 mm **auf Anfrage.**  
Distancia entre centros 50 mm **bajo pedido.**

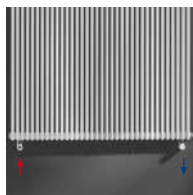

Allacciamento dal basso **a richiesta.**  
Bottom connection **on request.**  
Raccordement par le bas **sur demande.**  
Anschluss von unten **auf Anfrage.**  
Conexión por abajo **bajo pedido.**

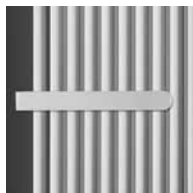

Barra portasciugamani short **a richiesta.**  
Short towel rail **on request.**  
Barre sèche-serviettes short **sur demande.**  
Handtuchtrockenstange Short **auf Anfrage.**  
Barra calentatoallas short **bajo pedido.**

\*\*\*  
EURO NORM  
**EN 442**

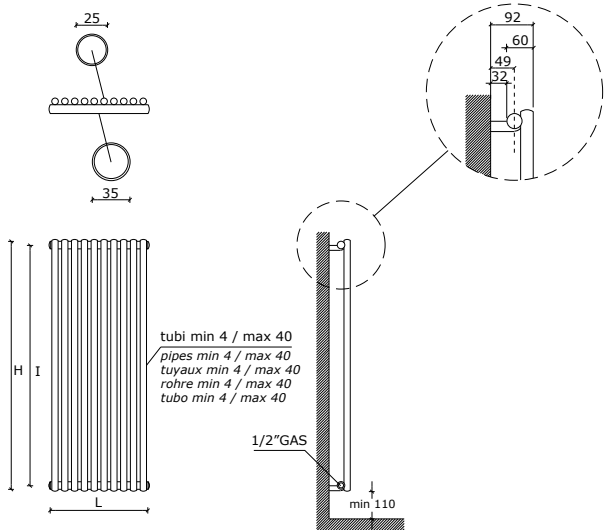

interasse dal centro foro al muro 49 mm  
distance between hole center and wall 49 mm  
distance du centre du trou au mur 49 mm  
Abstand zwischen Lochmitte und Wand 49 mm distancia  
entre el centro del agujero y el muro 49 mm

- I radiatori sono completi di kit di fissaggio a parete e valvola di sfogo.
- ~ Pressione di collaudo: 10,5 bar ~ Pressione di esercizio: 7 bar
- The radiators are equipped with a kit for fixing them to the wall and with an exhaust valve.
- ~ Testing pressure: 10,5 bar ~ Working pressure: 7 bar
- ~ Les radiateurs sont munis d'un kit de fixation murale et d'une soupape de décompression.
- ~ Pression d'essai: 10,5 bars ~ Pression d'exercice: 7 bars
- Die Heizkörper sind mit Wandbefestigungsset und Luftventil ausgerüstet.
- ~ Prüfungsdruck: 10,5 bar ~ Betriebsdruck: 7 bar
- Los radiadores están provistos de kit de fijación a la pared y de válvula de desahogo.
- ~ Presión de ensayo: 10,5 bar ~ Presión de trabajo: 7 bar

Esempio per la compilazione del codice da indicare sull'ordine:  
Example for the filling in of the code to be indicated in the order:  
Exemple pour la compilation du code à indiquer dans la commande:  
Beispiel für die Zusammenstellung von in der Bestellung anzugeben Kode:  
Ejemplo para la cumplimentación del código a indicar en el pedido:

|        |                      |        |                     |   |
|--------|----------------------|--------|---------------------|---|
| Z      | 04                   | S      | ...                 | Z04S810   |
| Zigolo | N° elementi          | single | altezza radiatore   | esempio di codice completo:<br>Radiatore Zigolo<br>4 elementi<br>single altezza 810 |
| Zigolo | N° of elements       | single | height of radiator  | example of complete code:<br>Zigolo radiator<br>4 elements<br>single height 810     |
| Zigolo | Nombre éléments      | single | hauteur radiateur   | Exemple de code complet<br>Radiateur Zigolo<br>4 éléments<br>single hauteur 810     |
| Zigolo | Anzahl von Elementen | single | Höhe von Heizkörper | Beispiel von kompletten Kode:<br>Zigolo<br>4 Elemente<br>Single Höhe 810            |
| Zigolo | N° de elementos      | single | altura del radiador | Ejemplo de código completo<br>Radiador Zigolo<br>4 elementos<br>single altura 810   |



Zigolo single è disponibile anche nelle versioni **solo elettrica** o in **versione mista**.  
Per informazioni vedi listino elettrici o tel. 0039 030 2530054

Zigolo Single is available also in all **electric version** or in **dual energy version**.

For information please see Electric pricelist or contact phone number 0039 030 2530054

Zigolo Single est disponible aussi in version **seulement électrique** ou en **version mixte**.

Voir la liste des prix radiateurs électriques ou contacter le numéro téléphonique 0039 030 2530054

Zigolo Single ist in **elektrischer Ausführung** oder in **gemischter Ausführung** lieferbar.

Bitte sehen Sie die elektrische Preisliste oder rufen Sie die Nr. 0039 030 2530054 an

Zigolo Single es disponible también en **version eléctrica** o en **version mixta**.

Por información ver la lista de precios electricos o ponerse en contact con 0039 030 2530054

**Materiale: acciaio al carbonio**

Material: carbon-steel

Matière: Acier au charbon

Stoff: Kohlenstoffstahl

Material: Acero de carbono



# Zigolo 25 double

caleido®  
design radiators

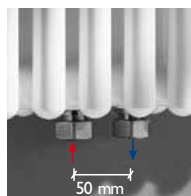

Interasse 50 mm **a richiesta.**  
50 mm centre distance **on request.**  
Entraxe 50 mm **sur demande.**  
Achsabstand 50 mm **auf Anfrage.**  
Distancia entre centros 50 mm **bajo pedido.**

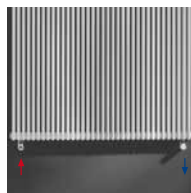

Allacciamento dal basso **a richiesta.**  
Bottom connection **on request.**  
Raccordement par le bas **sur demande.**  
Anschluss von unten **auf Anfrage.**  
Conexión por abajo **bajo pedido.**



Barra portasciugamani short **a richiesta.**  
Short towel rail **on request.**  
Barre sèche-serviettes short **sur demande.**  
Handtuchtrockenstange Short **auf Anfrage.**  
Barra calentatoallas short **bajo pedido.**

EN 442

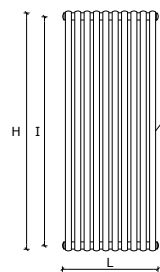
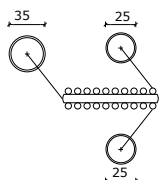

tubi min 4 / max 40  
pipes min 4 / max 40  
tuyaux min 4 / max 40  
röhre min 4 / max 40  
tubo min 4 / max 40

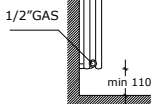

interasse dal centro foro al muro 55 mm  
distance between hole center and wall 55 mm  
distance du centre du trou au mur 55 mm  
Abstand zwischen Lochmitte und Wand 55 mm distancia  
entre el centro del agujero y el muro 55 mm

**Materiale: acciaio al carbonio**  
Material: carbon-steel  
Matière: Acier au charbon  
Stoff: Kohlenstoffstahl  
Material: Acero de carbono

- I radiatori sono completi di kit di fissaggio a parete e valvola di sfianto.
- Pressione di collaudo: 10,5 bar ~ Pressione di esercizio: 7 bar
- La versione cromata NON è disponibile.
- The radiators are equipped with a kit for fixing them to the wall and with an exhaust valve.
- Testing pressure: 10,5 bar ~ Working pressure: 7 bar
- Chromate radiators NOT available.
- Les radiateurs sont munis d'un kit de fixation murale et d'une soupape de décompression.
- Pression d'essai: 10,5 bars ~ Pression d'exercice: 7 bars
- La version chromée N'est PAS disponible.
- Die Heizkörper sind mit Wandbefestigungsset und Luftventil ausgerüstet.
- Prüfungsdruck: 10,5 bar ~ Betriebsdruck: 7 bar
- Die verchromte Version ist nicht verfügbar.
- Los radiadores están provistos de kit de fijación a la pared y de válvula de desahogo.
- Presión de ensayo: 10,5 bar ~ Presión de trabajo: 7 bar
- La versión cromada NO está disponible.

Esempio per la compilazione del codice da indicare sull'ordine:  
Example for the filling in of the code to be indicated in the order:  
Exemple pour la compilation du code à indiquer dans la commande:  
Beispiel für die Zusammenstellung von in der Bestellung anzugeben Kode:  
Ejemplo para la cumplimentación del código a indicar en el pedido:

| Z      | 04                   | D      | ...                 | Z04D810   |
|--------|----------------------|--------|---------------------|---|
| Zigolo | N° elementi          | double | altezza radiatore   | esempio di codice completo:<br>Radiatore Zigolo<br>4 elementi<br>double altezza 810 |
| Zigolo | N° of elements       | double | height of radiator  | example of complete code:<br>Zigolo radiator<br>4 elements<br>double height 810     |
| Zigolo | Nombre éléments      | double | hauteur radiateur   | Exemple de code complet<br>Radiateur Zigolo<br>4 éléments<br>double hauteur 810     |
| Zigolo | Anzahl von Elementen | double | Höhe von Heizkörper | Beispiel von kompletten Kode-<br>Heizkörper Zigolo<br>4 Elemente<br>Double Höhe 810 |
| Zigolo | N° de elementos      | double | altura del radiador | Ejemplo de código completo<br>Radiador Zigolo<br>4 elementos<br>double altura 810   |



# Zigolo 25 triple

caleido®  
design radiators

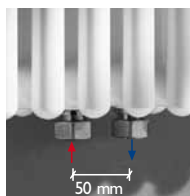

Interasse 50 mm **a richiesta.**  
50 mm centre distance **on request.**  
Entraxe 50 mm **sur demande.**  
Achsabstand 50 mm **auf Anfrage.**  
Distancia entre centros 50 mm **bajo pedido.**

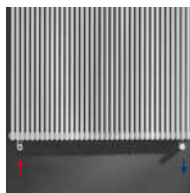

Allacciamento dal basso **a richiesta.**  
Bottom connection **on request.**  
Raccordement par le bas **sur demande.**  
Anschluss von unten **auf Anfrage.**  
Conexión por abajo **bajo pedido.**

Interasse dal centro foro al muro: mandata e ritorno 115 mm  
Distance between hole centre and wall: inlet and outlet 115 mm  
Distance du centre du trou au mur: entrée et sortie 115 mm  
Abstand zwischen Lochmitte und Wand: Vorlauf und Rücklauf 115 mm  
Distancia entre el centro del agujero y el muro: entrada y salida 115 mm

· I radiatori sono completi di kit di fissaggio a parete e valvola di sfogo.  
~ Pressione di collaudo: 10,5 bar ~ Pressione di esercizio: 7 bar  
· La versione cromata NON è disponibile.

· The radiators are equipped with a kit for fixing them to the wall and with an exhaust valve.  
~ Testing pressure: 10,5 bar ~ Working pressure: 7 bar  
~ Chromate radiators NOT available.

· Les radiateurs sont munis d'un kit de fixation murale et d'une soupape de décompression.  
~ Pression d'essai: 10,5 bars ~ Pression d'exercice: 7 bars  
· La version chromée N'est PAS disponible.

· Die Heizkörper sind mit Wandbefestigungsset und Luftventil ausgerüstet.  
~ Prüfungsdruck: 10,5 bar ~ Betriebsdruck: 7 bar  
· Die verchromte Version ist nicht verfügbar.

· Los radiadores están provistos de kit de fijación a la pared y de válvula de desahogo.  
~ Presión de ensayo: 10,5 bar ~ Presión de trabajo: 7 bar  
· La versión cromada NO está disponible.

\*\*\*  
EURO NORM  
**EN 442**

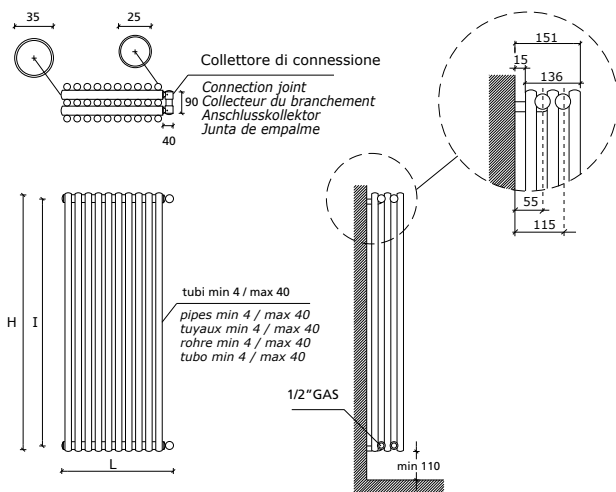

Interasse dal centro foro al muro: ↑ mandata 55 mm - ↓ ritorno 115 mm  
OPPURE ↑ mandata 115 mm - ↓ ritorno 55 mm  
Distance between hole centre and wall: ↑ inlet 55 mm - ↓ outlet 115 mm  
OR ↑ inlet 115 mm - ↓ outlet 55 mm  
distance du centre du trou au mur: ↑ entrée 55 mm - ↓ sortie 115 mm  
OU ↑ entrée 115 mm - ↓ sortie 55 mm  
Abstand zwischen Lochmitte und Wand: ↑ Vorlauf 55 mm - ↓ Rücklauf 115 mm  
ODER ↑ Vorlauf 115 mm - ↓ Rücklauf 55 mm  
distancia entre el centro del agujero y el muro: ↑ entrada 55 mm - ↓ salida 115 mm  
O ↑ entrada 115 mm - ↓ salida 55 mm

Materiale: acciaio al carbonio  
Material: carbon-steel  
Matière: Acier au charbon  
Stoff: Kohlenstoffstahl  
Material: Acero de carbono

Esempio per la compilazione del codice da indicare sull'ordine:  
Example for the filling in of the code to be indicated in the order:  
Exemple pour la compilation du code à indiquer dans la commande:  
Beispiel für die Zusammenstellung von in der Bestellung anzugeben Kode:  
Ejemplo para la cumplimentación del código a indicar en el pedido:

|        |                      |        |                     |   |
|--------|----------------------|--------|---------------------|---|
| Z      | 04                   | T      | ...                 | <b>Z04T810</b>  |
| Zigolo | N° elementi          | triple | altezza radiatore   | esempio di codice completo:<br>Radiatore Zigolo<br>4 elementi<br>triple altezza 810 |
| Zigolo | N° of elements       | triple | height of radiator  | example of complete code:<br>Zigolo radiator<br>4 elements<br>triple height 810     |
| Zigolo | Nombre éléments      | triple | hauteur radiateur   | Exemple de code complet<br>Radiateur Zigolo<br>4 éléments<br>triple hauteur 810     |
| Zigolo | Anzahl von Elementen | triple | Höhe von Heizkörper | Beispiel von kompletten Kode-<br>Heizkörper Zigolo<br>4 Elemente<br>Triple Höhe 810 |
| Zigolo | N° de elementos      | triple | altura del radiador | Ejemplo de código completo<br>Radiador Zigolo<br>4 elementos<br>triple altura 810   |



# Zigolo 25 single cromo

caleido®  
design radiators

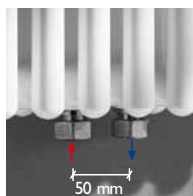

Interasse 50 mm **a richiesta.**  
50 mm centre distance **on request.**  
Entraxe 50 mm **sur demande.**  
Achsabstand 50 mm **auf Anfrage.**  
Distancia entre centros 50 mm **bajo pedido.**

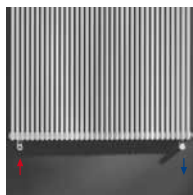

Allacciamento dal basso **a richiesta.**  
Bottom connection **on request.**  
Raccordement par le bas **sur demande.**  
Anschluss von unten **auf Anfrage.**  
Conexión por abajo **bajo pedido.**



Barra portasciugamani short **a richiesta.**  
Short towel rail **on request.**  
Barre sèche-serviettes short **sur demande.**  
Handtuchtrockenstange Short **auf Anfrage.**  
Barra calentatoallas short **bajo pedido.**

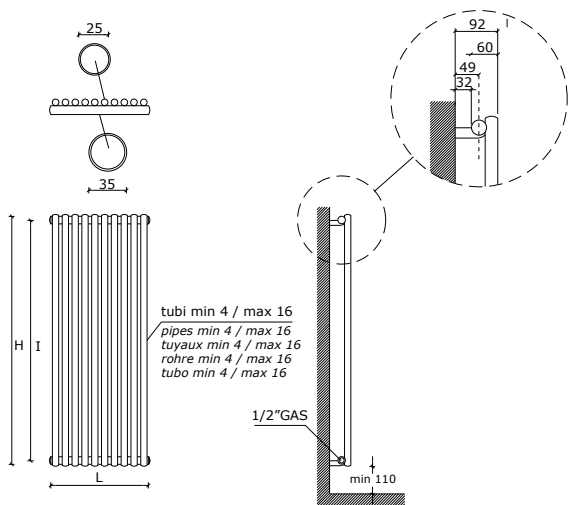

tubi min 4 / max 16  
pipes min 4 / max 16  
tuyaux min 4 / max 16  
rohre min 4 / max 16  
tubo min 4 / max 16

1/2" GAS

min 110

interasse dal centro foro al muro 49 mm  
distance between hole center and wall 49 mm  
distance du centre du trou au mur 49 mm  
Abstand zwischen Lochmitte und Wand 49 mm  
distancia entre el centro del agujero y el muro 49 mm

**Materiale: acciaio al carbonio**  
Material: carbon-steel  
Matière: Acier au charbon  
Stoff: Kohlenstoffstahl  
Material: Acero de carbono

Esempio per la compilazione del codice da indicare sull'ordine:  
Example for the filling in of the code to be indicated in the order:  
Exemple pour la compilation du code à indiquer dans la commande:  
Beispiel für die Zusammenstellung von in der Bestellung anzugeben Kode:  
Ejemplo para la cumplimentación del código a indicar en el pedido:

|        |                      |        |                     |   |
|--------|----------------------|--------|---------------------|---|
| Z      | 04                   | S      | ...                 | <b>Z04S810CR</b>  |
| Zigolo | N° elementi          | single | altezza radiatore   | esempio di codice completo:<br>Radiatore Zigolo<br>4 elementi<br>single altezza 810 cromo     |
| Zigolo | N° of elements       | single | height of radiator  | example of complete code:<br>Zigolo radiator<br>4 elements<br>single height 810 chrome        |
| Zigolo | Nombre éléments      | single | hauteur radiateur   | Exemple de code complet<br>Radiateur Zigolo<br>4 éléments<br>single hauteur 810 chrome        |
| Zigolo | Anzahl von Elementen | single | Höhe von Heizkörper | Beispiel von kompletten Kode-<br>Heizkörper Zigolo<br>4 Elemente<br>Single Höhe 810 verchromt |
| Zigolo | N° de elementos      | single | altura del radiador | Ejemplo de código completo<br>Radiador Zigolo<br>4 elementos<br>single altura 810 cromada     |

| Codice<br>Code<br>Code<br>Kode<br>Codigo | N°elementi<br>N° of elements | L<br>Larghezza<br>Width<br>Largeur<br>Breite<br>Longitud<br>mm | Interasse<br>Distance<br>between bars<br>Entraxe<br>Achsabstand<br>Centros<br>mm | H Altezza . Height . Hauteur . Hoehe . Altura / mm |     |     |     |     |     |      |      |      |      |   |
|--|------------------------------|--|--|--|-----|-----|-----|-----|-----|------|------|------|------|---|
|  |                              |  |  | 410  | 510 | 610 | 710 | 810 | 910 | 1010 | 1210 | 1510 | 1810 |   |
|  |                              |  |  | 360  | 460 | 560 | 660 | 760 | 860 | 960  | 1160 | 1460 | 1760 |   |
| OUTPUT                                   |                              |  |  | W  | W   | W   | W   | W   | W   | W    | W    | W    | W    | W |
| Z04S...CR                                | 4                            | 154  | (75/65/20) wΔt50   | 70   | 84  | 97  | 111 | 124 | 137 | 150  | 176  | 215  | 254  |   |
|  |                              |  | (55/45/20) wΔt30   | 37   | 44  | 51  | 58  | 65  | 72  | 79   | 92   | 111  | 131  |   |
|  |                              |  | (55/45/24) wΔt26   | 31   | 37  | 43  | 49  | 54  | 60  | 66   | 76   | 93   | 109  |   |
| Z05S...CR                                | 5                            | 193  | (75/65/20) wΔt50   | 87   | 104 | 121 | 138 | 155 | 171 | 188  | 220  | 269  | 318  |   |
|  |                              |  | (55/45/20) wΔt30   | 46   | 55  | 64  | 73  | 81  | 90  | 98   | 115  | 139  | 164  |   |
|  |                              |  | (55/45/24) wΔt26   | 39   | 46  | 54  | 61  | 68  | 75  | 82   | 96   | 116  | 136  |   |
| Z06S...CR                                | 6                            | 232  | (75/65/20) wΔt50   | 104  | 125 | 146 | 166 | 186 | 206 | 225  | 264  | 323  | 381  |   |
|  |                              |  | (55/45/20) wΔt30   | 56   | 67  | 77  | 87  | 98  | 108 | 118  | 138  | 167  | 196  |   |
|  |                              |  | (55/45/24) wΔt26   | 47   | 56  | 64  | 73  | 82  | 90  | 98   | 115  | 139  | 163  |   |
| Z07S...CR                                | 7                            | 271  | (75/65/20) wΔt50   | 122  | 146 | 170 | 193 | 217 | 240 | 263  | 308  | 377  | 445  |   |
|  |                              |  | (55/45/20) wΔt30   | 65   | 78  | 90  | 102 | 114 | 126 | 137  | 161  | 195  | 229  |   |
|  |                              |  | (55/45/24) wΔt26   | 54   | 65  | 75  | 85  | 95  | 105 | 115  | 134  | 162  | 190  |   |
| Z08S...CR                                | 8                            | 310  | (75/65/20) wΔt50   | 139  | 167 | 194 | 221 | 248 | 274 | 301  | 353  | 431  | 509  |   |
|  |                              |  | (55/45/20) wΔt30   | 74   | 89  | 103 | 117 | 130 | 144 | 157  | 184  | 223  | 262  |   |
|  |                              |  | (55/45/24) wΔt26   | 62   | 74  | 86  | 97  | 109 | 120 | 131  | 153  | 185  | 217  |   |
| Z09S...CR                                | 9                            | 349  | (75/65/20) wΔt50   | 156  | 188 | 218 | 249 | 279 | 308 | 338  | 397  | 484  | 572  |   |
|  |                              |  | (55/45/20) wΔt30   | 83   | 100 | 116 | 131 | 147 | 162 | 177  | 207  | 251  | 294  |   |
|  |                              |  | (55/45/24) wΔt26   | 70   | 84  | 97  | 110 | 122 | 135 | 147  | 172  | 209  | 244  |   |
| Z10S...CR                                | 10                           | 388  | (75/65/20) wΔt50   | 174  | 209 | 243 | 276 | 310 | 343 | 376  | 441  | 538  | 636  |   |
|  |                              |  | (55/45/20) wΔt30   | 93   | 111 | 128 | 146 | 163 | 179 | 196  | 230  | 279  | 327  |   |
|  |                              |  | (55/45/24) wΔt26   | 78   | 93  | 107 | 122 | 136 | 150 | 164  | 191  | 232  | 272  |   |
| Z11S...CR                                | 11                           | 427  | (75/65/20) wΔt50   | 191  | 230 | 267 | 304 | 341 | 377 | 413  | 485  | 592  | 699  |   |
|  |                              |  | (55/45/20) wΔt30   | 102  | 122 | 141 | 160 | 179 | 197 | 216  | 252  | 307  | 360  |   |
|  |                              |  | (55/45/24) wΔt26   | 85   | 102 | 118 | 134 | 150 | 165 | 180  | 210  | 255  | 299  |   |
| Z12S...CR                                | 12                           | 466  | (75/65/20) wΔt50   | 209  | 251 | 291 | 332 | 372 | 411 | 451  | 529  | 646  | 763  |   |
|  |                              |  | (55/45/20) wΔt30   | 111  | 133 | 154 | 175 | 196 | 215 | 236  | 275  | 334  | 393  |   |
|  |                              |  | (55/45/24) wΔt26   | 93   | 111 | 129 | 146 | 163 | 180 | 197  | 229  | 278  | 326  |   |
| Z13S...CR                                | 13                           | 505  | (75/65/20) wΔt50   | 226  | 271 | 315 | 359 | 403 | 445 | 488  | 573  | 700  | 826  |   |
|  |                              |  | (55/45/20) wΔt30   | 120  | 144 | 167 | 189 | 212 | 233 | 255  | 298  | 362  | 425  |   |
|  |                              |  | (55/45/24) wΔt26   | 101  | 121 | 140 | 158 | 177 | 195 | 213  | 249  | 301  | 353  |   |
| Z14S...CR                                | 14                           | 544  | (75/65/20) wΔt50   | 243  | 292 | 340 | 387 | 434 | 480 | 526  | 617  | 753  | 890  |   |
|  |                              |  | (55/45/20) wΔt30   | 130  | 155 | 180 | 204 | 228 | 251 | 275  | 321  | 390  | 458  |   |
|  |                              |  | (55/45/24) wΔt26   | 109  | 130 | 150 | 171 | 191 | 210 | 229  | 268  | 324  | 380  |   |
| Z15S...CR                                | 15                           | 583  | (75/65/20) wΔt50   | 261  | 313 | 364 | 414 | 465 | 514 | 563  | 661  | 807  | 953  |   |
|  |                              |  | (55/45/20) wΔt30   | 139  | 166 | 193 | 219 | 244 | 269 | 295  | 344  | 418  | 491  |   |
|  |                              |  | (55/45/24) wΔt26   | 116  | 139 | 161 | 183 | 204 | 225 | 246  | 287  | 348  | 407  |   |
| Z16S...CR                                | 16                           | 622  | (75/65/20) wΔt50   | 278  | 334 | 388 | 442 | 496 | 548 | 601  | 705  | 861  | 1017 |   |
|  |                              |  | (55/45/20) wΔt30   | 148  | 177 | 205 | 233 | 261 | 287 | 314  | 367  | 446  | 524  |   |
|  |                              |  | (55/45/24) wΔt26   | 124  | 149 | 172 | 195 | 218 | 240 | 262  | 306  | 371  | 435  |   |

· I radiatori sono completi di kit di fissaggio a parete e valvola di sfogo.

~ Pressione di collaudo: 10,5 bar ~ Pressione di esercizio: 7 bar

\* I watt hanno valori provvisori in attesa di certificazione Δt50.

· The radiators are equipped with a kit for fixing them to the wall and with an exhaust valve.

~ Testing pressure: 10,5 bar ~ Working pressure: 7 bar

\* The watt values are not definitive awaiting for Δt50 certification.

· Les radiateurs sont munis d'un kit de fixation murale et d'une soupape de décompression.

~ Pression d'essai: 10,5 bars ~ Pression d'exercice: 7 bars

\* Le nombre de Watts est une valeur indiquée à titre provisoire dans l'attente de la certification Δt50.

· Die Heizkörper sind mit Wandbefestigungsset und Luftventil ausgerüstet.

~ Prüfungsdruck: 10,5 bar ~ Betriebsdruck: 7 bar

\* Die Wattwerte sind noch provisorisch in Erwartung von Δt50 Zertifizierung.

· Los radiadores están provistos de kit de fijación a la pared y de válvula de desahogo.

~ Presión de ensayo: 10,5 bar ~ Presión de trabajo: 7 bar

\* Los Vatios tienen valores provisionales en espera de la certificación Δt50.



# COLORI . COLOURS . COULEURS . FARBEN . COLORES

## STANDARD



9010 RAL bianco puro opaco / pure white matt / blanc pur mat / mattes reines Weiß / Blanco puro mate  
di serie Fine Design e Metacrilati / Standard for Fine Design and Metacrilati / de série pour Fine Design et Metacrilati  
serienmäßig Fine Design und Metacrilati / de serie por Fine Design y Metacrilati

## GRUPPO A - GROUP A - GROUPE A - GRUPPE A - GRUPO A



bianco B7 ruvido / rough white B7 / blanc B7 rugueux / grobes Weiß B7 / Blanco B7 rugoso



9001 RAL pergamon bianco / pergamon white / blanc pergamon / Pergamon-Weiß / Blanco pergamon

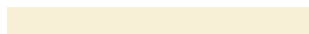

1013 RAL bianco perla opaco / pearl white matt / blanc perle mat / mattes Perlweiß / Blanco perla mate



1015 RAL avorio chiaro opaco / light ivory matt / ivoire clair mat / mattes helles Elfenbein / Marfil claro mate



1014 RAL avorio opaco / ivory matt / ivoire mat / mattes Eifenbein / Marfil mate



1001 RAL beige opaco / beige matt / blanc mat / mattes Beige / Beige mate



3000 RAL rosso / red / rouge / rot / Rojo



3002 RAL rosso carminio opaco / red chrome matt / rouge carmin mat / mattes Karminrot / Rojo carmin mate



3003 RAL rosso rubino opaco / ruby red matt / rouge rubis mat / mattes Rubinrot / Rojo rubí mate



3004 RAL rosso porpora opaco / purple red matt / rouge pourpre mat / mattes Purpurrot / Rojo púrpura mate



1021 RAL giallo / yellow / jaune / gelb / Amarillo



6019 RAL verde / green / vert / grün / Verde



6016 RAL verde / green / vert / grün / Verde



calypso



5014 RAL colomba opaco / blue pigeon matt / blue pigeon mat / mattes taubenblau / Azul colomblano



5015 RAL blu / blue / bleu / blau / Azul celeste



azzurro toscana / light blue Tuscany sky / bleu ciel Toscane / toscanablau / Azul celeste Toscana



royal blue semiopaco / royal blue half-matt / royal blue semi-mat / halbmattes königsblau / Azul real semimate

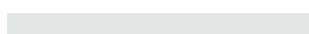

manhattan



7011 RAL grigio ferro opaco / iron grey matt / gris fer mat / mattes Eisengrau / Gris hierro mate



7015 RAL grigio ardesia opaco / slate grey matt / gris ardoise mat / mattes Schiefergrau / Gris pizarra mate



7016 RAL grigio antracite opaco / anthracite grey matt / gris anthracite mat / mattes Anthrazitgrau / Gris antracita mate



7021 RAL grigio nerastro opaco / blackish grey matt / gris foncé mat / mattes Schwarzgrau / Gris negruzco mate



nero N4 ruvido / rough black N4 / noir N4 rugueux / grobes Schwarz N4 / Negro N4 rugoso



9005 RAL nero intenso / deep black / noir profond / sattes Schwarz / Negro intenso



9011 RAL nero grafite / black lead / noir graphite / Graphitschwarz / Negro grafito

## GRUPPO B - GROUP B - GROUPE B - GRUPPE B - GRUPO B



4005 RAL lilla ruvido / lilac rough / lilas rugueux / Lila groß / lila rugoso

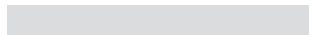

met iron BD RAG ruvido / met iron BD RAG rough / fer métallisé BD RAG rugueux  
met iron BD RAG grob / hierro metalizado BD RAG rugoso



met grigio 3 RAG ruvido opaco / met grey 3 RAG rough matt / gris métallisé 3RAG rugueux mat  
met grau 3 RAG grob / gris metalizado BD RAG rugoso mate

## GRUPPO C - GROUP C - GROUPE C - GRUPPE C - GRUPO C



marrone satinato / satined brown / marron satiné / Braun satiniert / marrón satinado



1036 RAL oro perla / pearl gold / or perle / perle gold / oro perlado



verniciato satinato / painted satined / peint satiné / lackiert satiniert / pintado satinado