

CATALOGO

CATALOGUE



FECIS
GROUP

Tutte le fotografie, le finiture, i dati e le caratteristiche tecniche sono indicative e Radiatori 2000 può applicare modifiche senza preavviso.

Pictures, finishes, data and technical specifications are indicative. Radiatori 2000 reserves the right to change or modify them at any time without notice.

SOMMARIO / SUMMARY

IL GRUPPO FECS / <i>FECS GROUP</i>	5
RADIATORI 2000 NEL MONDO / <i>In the world</i>	6
I NOSTRI VALORI / <i>Our values</i>	7
PERCHÈ L'ALLUMINIO / <i>Aluminium: why?</i>	8
I NOSTRI VANTAGGI / <i>Our advantages</i>	9
OTTIMO	11
HELYOS EVO	15
PLUS EVO	17
KALDO	19
OTTIMO+	21
KALDUS	23
KALIS	25
KALIS BATH	27
COVER	29
VULKANO	31
INSTALLAZIONE / <i>Installation</i>	33
VERSATILITÀ ED ENERGIA / <i>Versatility and energy</i>	34
QUALITÀ E CERTIFICAZIONI / <i>Quality & certifications</i>	35
ALLACCIAMENTI / <i>Connections</i>	36
ACCESSORI / <i>Accessories</i>	37
RESE TERMICHE / <i>Thermal output</i>	38
FINITURE DISPONIBILI / <i>Available finishes</i>	40



IL GRUPPO FECS / FECS GROUP

Radiatori 2000 Spa fa parte del **GRUPPO FECS**, realtà industriale in grado di **garantire al suo interno l'intera filiera produttiva e la completa tracciabilità dell'alluminio**: dal recupero del rottame proveniente dalla raccolta differenziata, ma anche dai componenti di automobili e di elettrodomestici, alla produzione di semilavorati fino alla realizzazione del prodotto finito, pronto per essere installato. Un laboratorio scientifico in cui la materia prima viene trasformata in radiatori.

Così Radiatori 2000 Spa **recupera l'alluminio di scarto, lo ricicla e lo rimette sul mercato sotto forma di radiatori dalle altissime prestazioni termiche.**

Radiatori 2000 Spa is a member of the FECS INDUSTRIAL GROUP, that has given life to a verticalized industrial system, which is self-sufficient and can handle most effectively each and every stage of radiator production and the full traceability: from the salvage of scrap metal obtained from the separate collection of waste materials or the dismantling of end-of-life vehicles and appliances, up to the realization of the finished product, ready to be installed. A scientific laboratory, where the raw material is converted into a work of art. Radiatori 2000 Spa recovers aluminum waste, recycles it and puts it on the market again as high-performance thermal radiators.

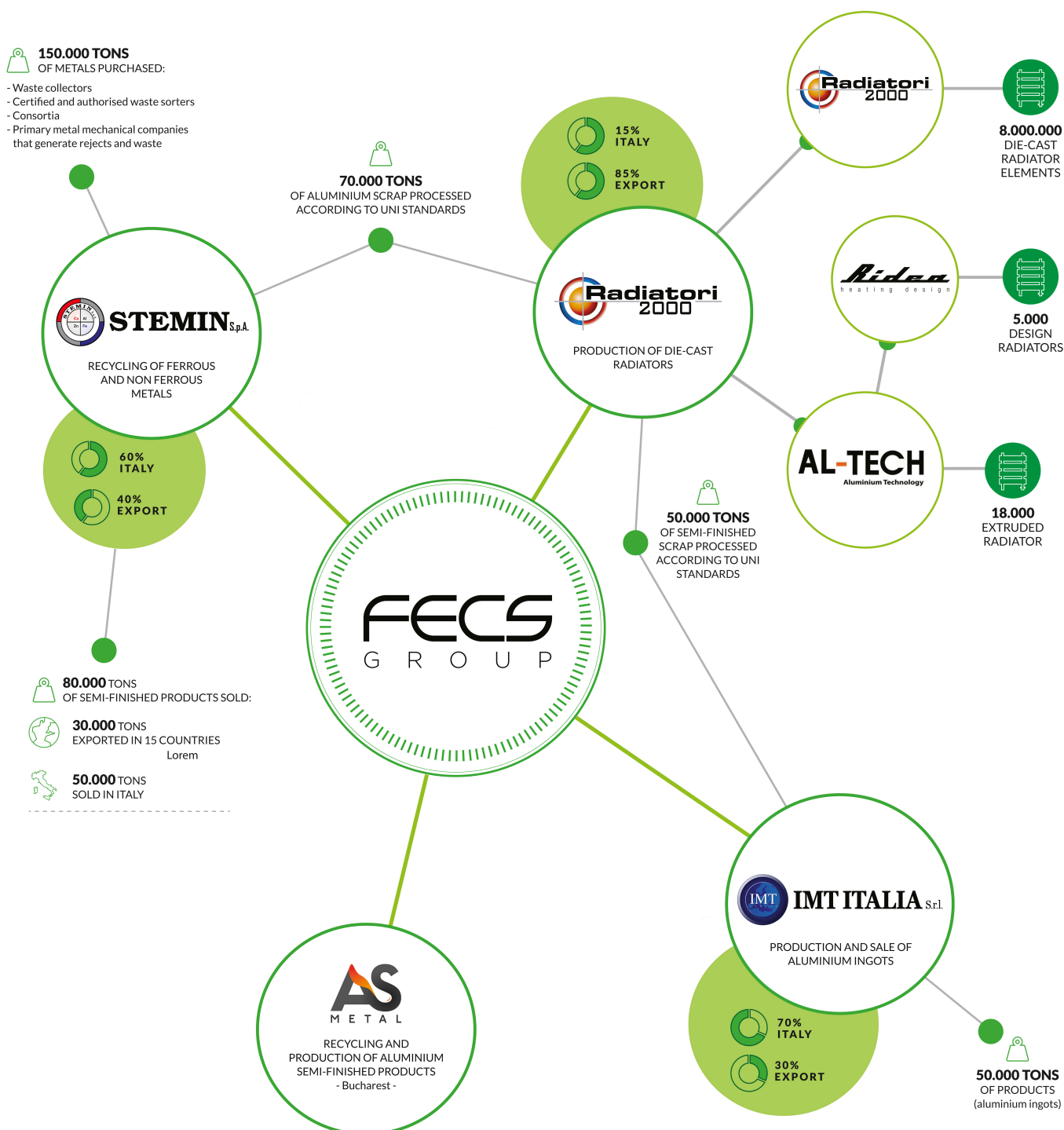

RADIATORI 2000 NEL MONDO / IN THE WORLD

Radiatori 2000 Spa, azienda bergamasca che da anni opera con successo nel settore dei radiatori in **alluminio pressofuso**, diventandone uno dei leader mondiali, con i suoi marchi Radiatori 2000, Ridea e Al-Tech offre una **vasta gamma di soluzioni termo idrauliche molto performanti** in grado di soddisfare i desideri degli utenti più esigenti dal punto di vista dell'efficienza energetica e attenti alle tendenze dell'interior design.

Radiatori 2000 Spa vanta la collaborazione dei principali centri di ricerca tecnica e tecnologica italiani (tra cui il Dipartimento di Energetica del Politecnico di Milano, che ha certificato le rese termiche), oltre che il supporto di importanti studi di architettura e design italiani come Giulio Cappellini e Meneghello Paoletti Associati.

Radiatori 2000 Spa during the last decade has worked successfully in the field of die-cast and extruded aluminium radiators and has become a world leader in this sector, with its Radiatori 2000, Ridea and Al-Tech brands offers a wide range of thermo-hydraulic solutions designed to meet the requirements of the most demanding customers, who seek maximum energy efficiency and are aware of the latest interior design trends.

Radiatori 2000 Spa also includes the collaboration of the Italian leading research centers of technical and technological (including the Energy Department of the Politecnico di Milano, which certified their thermal output), as well as the support of major architecture and italian designers as Giulio Cappellini and Meneghello Paoletti Associati.



Radiatori 2000 Spa opera in più di 50 paesi nel mondo.

Radiatori 2000 Spa operates in more than 50 different countries.

Radiatori 2000 Spa si sviluppa su una superficie di 40.000 mq e rappresenta un'eccellenza d'avanguardia grazie all'elevata tecnologia degli impianti e dei macchinari.

The industrial complex of RADIATORI 2000 Spa extends over an area of 40,000 mq and is at the leading edge of technology with its automated systems and machinery.



I NOSTRI VALORI / OUR VALUES

Responsabilità ambientale

La cultura sostenibile è il vero caposaldo della filosofia di Radiatori 2000 Spa. Da sempre attenta e rispettosa dell'ambiente tanto da utilizzare solo alluminio riciclato, **in grado di ridurre le emissioni di CO₂ del 95%.**

In quest'ottica l'impresa ha ottenuto la prestigiosa **certificazione sul sistema di gestione ambientale** aziendale denominata **UNI EN ISO 14001.**

Innovazione

L'azienda è da sempre all'avanguardia per **l'innovazione, la qualità e la straordinaria affidabilità dei suoi prodotti.** I processi e macchinari di lavoro, oggetto di continui aggiornamenti grazie all'adozione di nuove tecnologie, rendono il **metodo di produzione unico**, come i suoi prodotti.

Efficienza

L'esperienza e le capacità che sono alla base della produzione sono state affiancate, nel corso degli anni, dalle più innovative **tecnologie** e dai macchinari più efficienti.

Made in Italy

L'intera produzione è rigorosamente Made in Italy e rappresenta il meglio della produzione italiana.

SUSTAINABLE CULTURE

The sustainable culture is the true cornerstone of the philosophy of Radiatori 2000 Spa. Always careful and respectful of the environment so as to use only recycled aluminum can reduce CO₂ emissions by 95%.

In this perspective, the company has obtained the prestigious UNI EN ISO 14001 certification for its environmental management system.

INNOVATION

Radiatori 2000 Spa has always been at the forefront as far as innovation, quality and the extraordinary reliability of its products are concerned. Processes and machinery, subject to continuous updates thanks to the adoption of new technologies, make the unique production method, as its products.

EFFICIENCY

Experience and capability are the basis of our production and have been combined, during the years, to the most innovative technologies and the most efficient machinery.

MADE IN ITALY

The entire production represent the best in Italian-made production.

 **150.000 t**

150.000 le tonnellate di alluminio che ricicliamo ogni anno.

is the quantity of aluminium that we recycle every year

 **-300.000 t**

300.000 le tonnellate di CO₂ equivalente risparmiate, cioè che non emettiamo in atmosfera.

is the reduction in equivalent CO₂ emission i.e., the quantity of carbon of dioxide that is not release into the atmosphere

 **+ 450.000**

450.000 il numero di alberi necessari per riconvertire questa quantità di anidride carbonica.

is the number of trees it would take to convert this quantity of carbon dioxide.

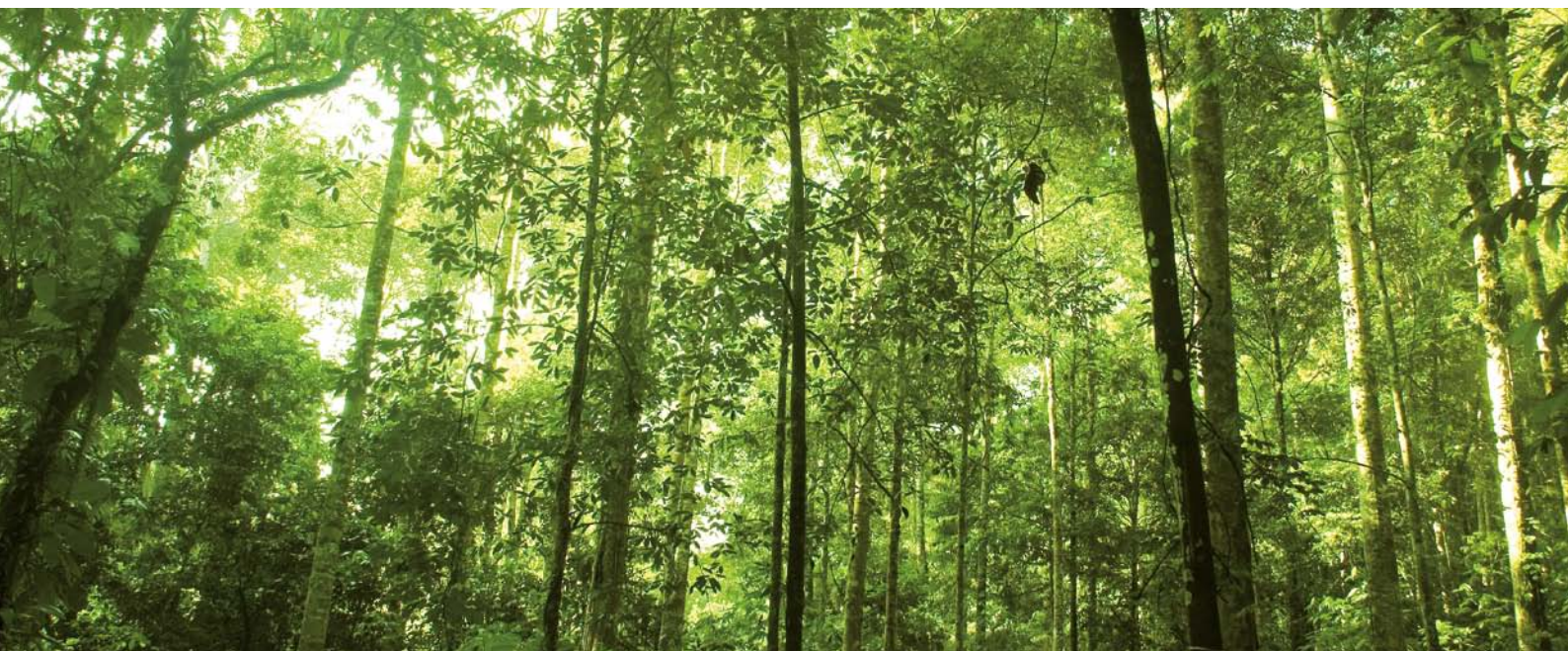

PERCHÈ L'ALLUMINIO / ALUMINIUM: WHY?

La totalità dei radiatori che produciamo è realizzata in alluminio riciclato. L'alluminio è il terzo elemento presente sulla Terra in una quota pari all'8% ed è **riciclabile all'infinito**. L'Italia è il terzo produttore al mondo di alluminio riciclato.

The entirety of our radiators produced is realized with recycled aluminium. Aluminium is the third element on the Earth with a percentage of about 8% and it's infinitely recyclable. Italy is the third largest producer of it.

Riduzione del peso / Weight reduction

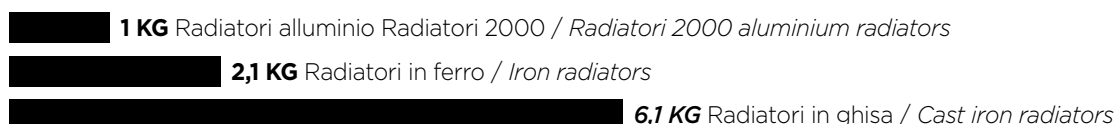

Peso a parità di resa termica / Weight at equal thermal efficiency

Minore consumo d'acqua / Lower usage of water

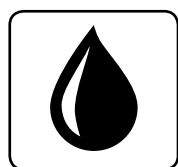

Quantità d'acqua a parità di resa termica / Quantity of water at equal thermal efficiency

Tempi di riscaldamento ridotti / Saving heating time



Messa a regime dei locali / Room heating capacity (5-21°C; Δt= 30°C)

Minori ingombri / Less space

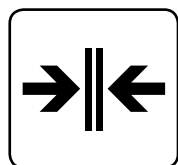

Resa termica a parità di ingombro / Thermal efficiency at equal dimensions

Maggiore flessibilità / Better flexibility

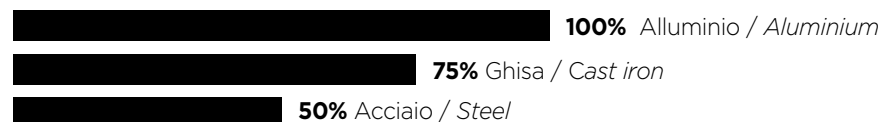
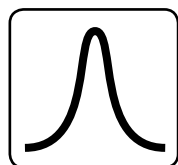

Flessibilità termica Δt= 50°C / Heating flexibility Δt= 50°C

I NOSTRI VANTAGGI / OUR ADVANTAGES

Elevato comfort ambientale

Maximum indoor comfort

Risparmio energetico

Energy saving

Utilizzabili con qualsiasi impianto anche a bassa temperatura

Compatible with low temperature and renewable energy sources

Facilità d'installazione

Easy installation

10 anni di garanzia

10 year product warranty

Risparmio economico nel bilancio familiare

Savings in the family budget



Ottimo: nasce il primo pressofuso di design!

Lo studio Meneghella&Paolelli Associati ha reinterpretato il classico modello di radiatore pressofuso donandogli una veste inedita e di forte connotazione di design.

Oltre che rinnovato esteticamente OTTIMO è tecnologicamente il miglior corpo scaldante grazie alle eccezionali prestazioni e alla resa superiori alla media.

**16
BAR**

The first die-casted radiators in aluminium!

Design studio Meneghella&Paolelli restyled the classic die-cast radiator to give it brand new looks, with strong design/artistic connotations.

Besides a refurbished appearance, OTTIMO stands out from the technological standpoint, with excellent than average thermal efficiency and performance.

MODELLO model	h (mm) altezza height	b (mm) larghezza width	i (mm) interasse center distance	p (mm) profondità depth	peso weight kg	contenuto d'acqua water content lt	resa termica / thermal output w		
							Δt 30°	Δt 50°	Δt 60°
500	598	80	500	103	1,4	0,5	54,1	103,2	129,9
600	698	80	600	103	1,6	0,5	62,1	118,6	149,4
800	898	80	800	103	2,1	0,7	76,8	149,2	189,1

dati tecnici completi a pag. 40 / full technical data on p. 40

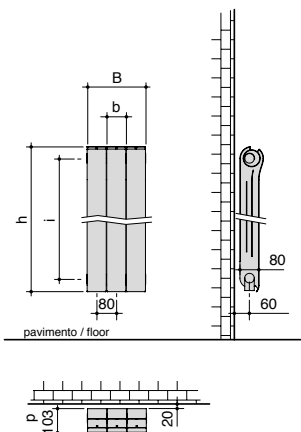

Finitura fotografata in queste pagine / Finish photographed on these pages:
Noir Sablè 200 - White 9016 Glossy



ACCESSORI / ACCESSORIES



Set Basic valvola e detentore
Basic valve and detentor set



4 tappi di design
4 design caps

accessori completi a pag. 39 / full accessories on p. 39

FINITURE DISPONIBILI / AVAILABLE FINISHES

Standard: RAL BIANCO LUCIDO 9016
RAL 9016 white glossy

Verniciature materiche
Textured paints



cartella colori completa a pag. 43 / full color chart on p. 43

ALLACCIAMENTI / CONNECTIONS

A B C D

allacciamenti a pag. 38 / connections on p. 38

OTTIMO

Il primo radiatore pressofuso di design al mondo!

The first design die-cast radiator in the world!



reddot award 2016
winner

PATENTED



Meneghello Paoelli Associati I designer

Sandro Meneghello e Marco Paoelli, entrambi classe 1979, si sono laureati con lode al Politecnico di Milano, Facoltà del Design, nel 2004, sotto la guida di eccelsi designer. Si riuniscono dopo diverse esperienze internazionali e dal 2005 collaborano con aziende italiane ed estere di fama internazionale. I loro prodotti sono stati esposti in tutto il mondo, e durante i loro dieci anni di attività hanno ricevuto vari riconoscimenti internazionali, tra cui 4 Red Dot Design Award (di cui 1 vinto nel 2014 con Ridea, marchio di Radiatori 2000 Spa), 2 Design Plus, 2 Good Design Award, un ADI Design Index, una menzione speciale per il German Design Award e sei menzioni allo Young&Design.

MENEGHELLO PAOLELLI ASSOCIATI The designers

Sandro Meneghello and Marco Paoelli, both born in 1979, graduated at the Politecnico di Milano, Faculty of Design, in 2004, under the guidance of influent designers. They separately gather different international experiences since 2005 they have collaborated with several Italian and foreign companies. During their ten years of collaboration, they have received several international recognitions, including four Red Dot Design Award (1 with Ridea, brand of Radiatori 2000 Spa), two Design Plus, two Good Design Award, one ADI Design Index, a special mention for the German Design Award and six mention to the Young&Design.



*... è un oggetto senza tempo
che trasmette sensazioni di novità e
gradevolezza per abitazioni
classiche o di design...*

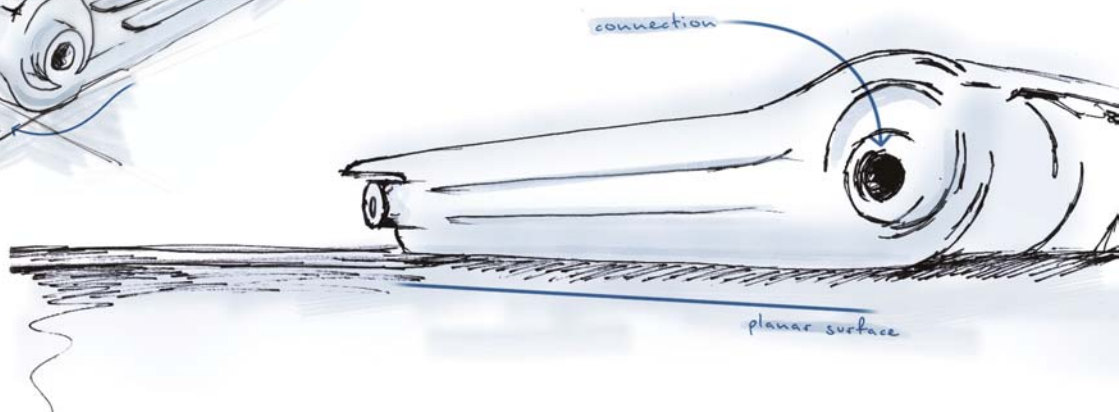
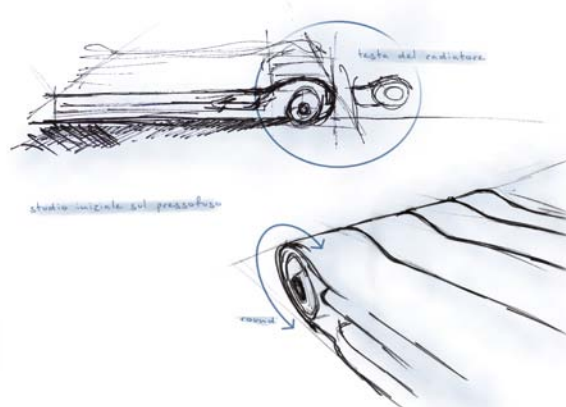
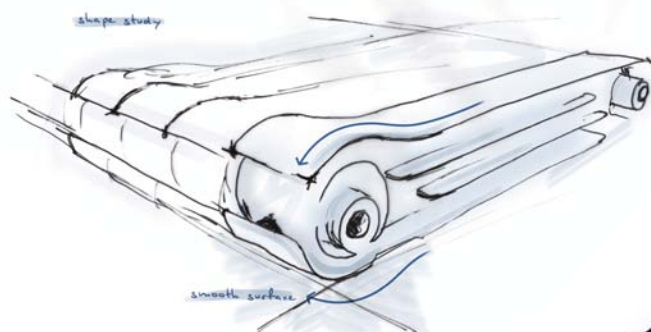

OTTIMO

Ottimo è un radiatore di design che reinterpreta in chiave contemporanea, con segni gentili, i tradizionali sistemi termoidraulici: è un oggetto senza tempo che trasmette sensazioni di novità e gradevolezza per abitazioni classiche o di design.

Gli accorgimenti estetici che alleggeriscono la linea di questo modello sono stati resi possibili grazie all'utilizzo dell'alluminio pressofuso che consente di ridurre al minimo gli spessori e il peso. I prodotti della linea Ottimo sono modulari e affiancabili".



reddot award 2016
winner



Radiatori 2000 rappresenta l'eccellenza italiana nel settore del riscaldamento. Grazie ad una produzione Made in Italy, una forte cultura sostenibile e una continua innovazione tecnologica è in grado di offrire una vasta gamma di radiatori molto efficienti e con un'estetica piacevole e curata: Helyos EVO è l'evoluzione del classico modello pressofuso: più leggero ed efficiente.

Radiatori 2000 represents the Italian excellence in the field of heating. Through an entire production Made in Italy, a very strong sustainable culture and a continuous technological innovation is able to offer a wide range of radiator very efficient and with a pleasing aesthetic: Helyos EVO, the evolution of the die-cast model: lighter and more efficient.

MODELLO model	h (mm) altezza height	b (mm) larghezza width	i (mm) interasse center distance	p (mm) profondità depth	peso weight kg	contenuto d'acqua water content lt	resa termica / thermal output w		
							Δt 30°	Δt 50°	Δt 60°
350	428	80	350	95	1,08	0,26	46,2	88,8	112,1
500	578	80	500	95	1,37	0,33	63,5	121,2	152,6
600	678	80	600	95	1,52	0,37	68,7	133,1	168,5
700	778	80	700	95	1,80	0,40	76,1	148,1	187,8
800	878	80	800	95	2,03	0,43	83,9	164,7	209,5



Pressione di Utilizzo / Operating Pressure **20 BAR**
 Massima Pressione / Explosion Pressure **> = 40 BAR**
 dati tecnici completi a pag. 40 / full technical data on p. 40

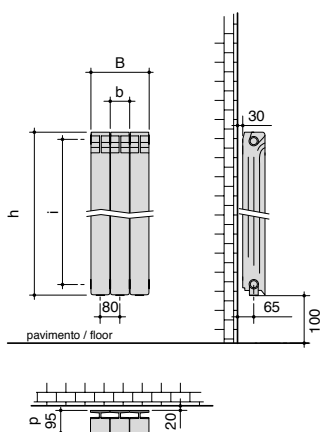

ACCESSORI / ACCESSORIES

Set Basic valvola e detentore
Basic valve and detentor set

Kit tappi, riduzioni e mensole
Caps, adaptors and brackets kit

accessori completi a pag. 39 / full accessories on p. 39



FINITURE DISPONIBILI / AVAILABLE FINISHES

Standard: RAL BIANCO LUCIDO 9016
RAL 9016 white glossy

Verniciature materiche
Textured paints

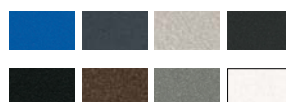

cartella colori completa a pag. 43 / full color chart on p. 43

ALLACCIAMENTI /



allacciamenti a pag. 38 / connections on p. 38

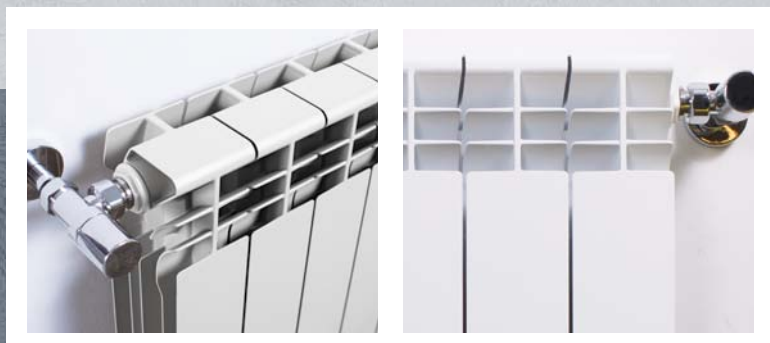

Efficienza e dinamismo

Efficiency and dynamism



HELLYOS EVO

Il modello PLUS EVO è il radiatore concepito per seguire l'evoluzione del design sempre più improntato su linee minimal e moderne, adatto a tutti gli ambienti.

PLUS EVO is the radiator specially conceived to follow the evolution of design, with a growing focus on minimal, contemporary lines, suitable for any home decor.

MODELLO model	h (mm) altezza height	b (mm) larghezza width	i (mm) interasse center distance	p (mm) profondità depth	peso weight kg	contenuto d'acqua water content lit	resa termica / thermal output w		
							Δt 30°	Δt 50°	Δt 60°
350	428	80	350	95	0,99	0,22	45,1	86,4	108,9
500	578	80	500	95	1,31	0,32	59,8	115,4	145,9
600	678	80	600	95	1,47	0,36	66,2	128,2	162,3
700	778	80	700	95	1,73	0,39	74,2	143,9	182,2
800	878	80	800	95	1,95	0,43	82,5	160,9	204,1

dati tecnici completi a pag. 40 / full technical data on p. 40

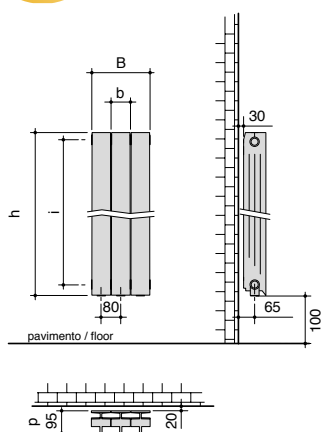

$B = (8 \times N) + 20$ mm
 $N = (\text{max } 14)$ n° elementi batteria
 (max 14) n° elements battery

Finitura fotografata in queste pagine / Finish photographed on these pages:
 Noir Sabliè 200 - White 9016 Glossy



ACCESSORI / ACCESSORIES



Set Basic valvola e detentore
Basic valve and detentor set



Kit tappi, riduzioni e mensole
Caps, adaptors and brackets kit



Coppia di fianchetti con tappi di design
Pair of sides with design caps

accessori completi a pag. 39 / full accessories on p. 39

FINITURE DISPONIBILI / AVAILABLE FINISHES

Standard: RAL BIANCO LUCIDO 9016
RAL 9016 white glossy

Verniciature materiche
Textured paints



cartella colori completa a pag. 43 / full color chart on p. 43

ALLACCIAMENTI / CONNECTIONS



allacciamenti a pag. 38 / connections on p. 38

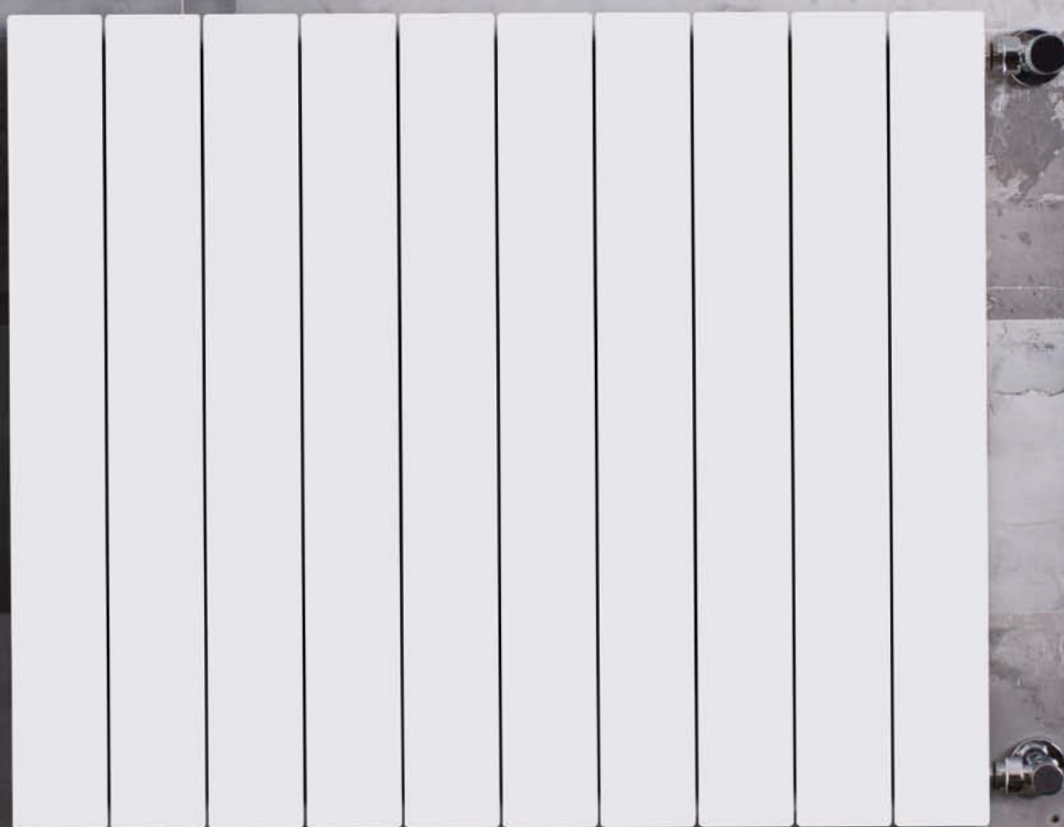

PLUS EVO

Eleganza contemporanea
Contemporary elegance

Il modello KALDO è il radiatore in alluminio pressofuso capace di creare un piacevole equilibrio estetico attraverso forme tondeggianti e una visione di insieme armoniosa.

KALDO, a radiator made of die-cast aluminium, creates an aesthetically pleasing balance with its rounded forms and harmonious overall appearance.

MODELLO model	h (mm) altezza height	b (mm) larghezza width	i (mm) interasse center distance	p (mm) profondità depth	peso weight kg	contenuto d'acqua water content lt	resa termica / thermal output w		
							Δt 30°	Δt 50°	Δt 60°
350	431	80	350	95	1,17	0,32	45,7	88,0	111,2
500	581	80	500	95	1,42	0,46	61,0	118,7	150,6
600	681	80	600	95	1,66	0,52	70,4	137,8	175,1
700	781	80	700	95	1,81	0,62	78,6	153,5	194,9
800	881	80	800	95	2,04	0,68	87,2	171,5	218,4

dati tecnici completi a pag. 40 / full technical data on p. 40

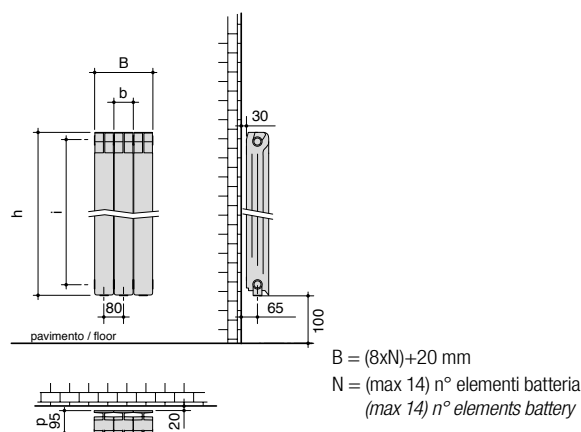

Finitura fotografata in queste pagine / Finish photographed on these pages:
Bronzo Scuro - White 9016 Glossy



ACCESSORI / ACCESSORIES



Set Basic valvola e detentore
Basic valve and detentor set



Kit tappi, riduzioni e mensole
Caps, adaptors and brackets kit

accessori completi a pag. 39 / full accessories on p. 39

FINITURE DISPONIBILI / AVAILABLE FINISHES

Standard: RAL BIANCO LUCIDO 9016
RAL 9016 white glossy

Verniciature materiche
Textured paints



cartella colori completa a pag. 43 / full color chart on p. 43

ALLACCIAMENTI / CONNECTIONS



allacciamenti a pag. 38 / connections on p. 38

Rigore armonioso
Pure, harmonious lines

KALDO

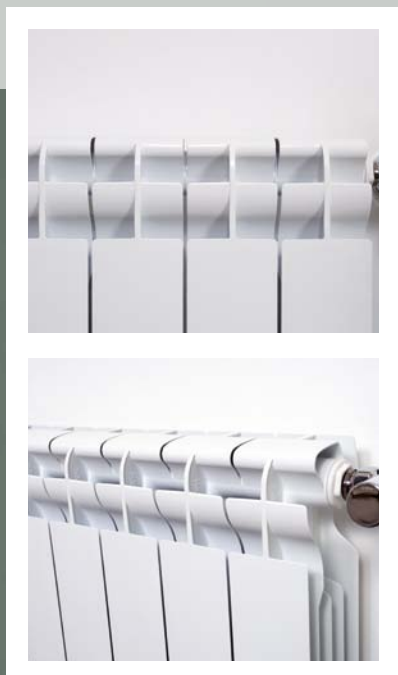

Quando il design incontra la potenza nasce il nuovo modello in estruso OTTIMO+. Disegnato dal team Meneghella Paoletti Associati e 100% Made in Italy.

When the design meets the power born the new extruded radiator OTTIMO+. Designed by team Meneghella Paoletti Associati and 100% Made in Italy.

MODELLO model	h (mm) altezza height	b (mm) larghezza width	i (mm) interasse center distance	p (mm) profondità depth	peso weight kg	contenuto d'acqua water content lt	resa termica / thermal output w		
							Δt 30°	Δt 50°	Δt 60°
900	980	80	900	106	1,9	0,40	86,4	168,1	213,1
1000	1080	80	1000	106	2,1	0,45	93,3	182,0	231,0
1200	1280	80	1200	106	2,4	0,50	106,7	209,1	265,8
1400	1480	80	1400	106	2,7	0,55	120,1	235,5	299,4
1600	1680	80	1600	106	3,0	0,60	133,2	261,3	332,3
1800	1880	80	1800	106	3,3	0,65	145,8	286,5	364,5
2000	2080	80	2000	106	3,6	0,70	158,2	311,3	396,3

dati tecnici completi a pag. 40 / full technical data on p. 40

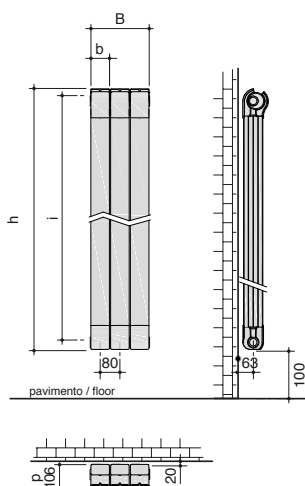

$B = (8 \times N) + 20$ mm
 $N = (\text{max } 6)$ n° elementi batteria
 (max 6) n° elements battery

ACCESSORI / ACCESSORIES



Set Basic valvola e detentore
Basic valve and detentor set



4 tappi di design
4 design caps

accessori completi a pag. 39 / full accessories on p. 39

ALLACCIAMENTI / CONNECTIONS



allacciamenti a pag. 38 / connections on p. 38

Finitura fotografata in queste pagine / Finish photographed on these pages: White 9016 Glossy

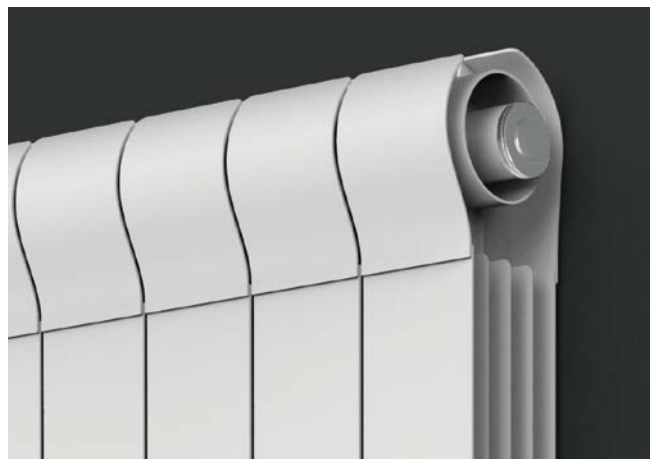

FINITURE DISPONIBILI / AVAILABLE FINISHES

Standard: RAL BIANCO LUCIDO 9016
RAL 9016 white glossy

Verniciature RAL / RAL paints



Verniciature materiche
Textured paints



Verniciature speciali
Special paints



cartella colori completa a pag. 43 / full color chart on p. 43



reddot award 2016
winner

**Possente ed
armonioso**

*Powerful and
harmonious*

OTTIMO+



Il modello KALDUS è il radiatore in alluminio estruso e pressofuso, nato dall'evoluzione del modello Kaldo, che si sviluppa in altezza donando anche ad ambienti ristretti un'ampia resa termica.

Made of extruded and die-cast aluminium, KALDUS is a new, taller version of the Kaldo model, specially designed to guarantee an excellent thermal yield, even in tight spaces.

MODELLO model	h (mm) altezza height	b (mm) larghezza width	i (mm) interasse center distance	p (mm) profondità depth	peso weight kg	contenuto d'acqua water content lt	resa termica / thermal output w		
							Δt 30°	Δt 50°	Δt 60°
900	970	80	900	100	1,87	0,38	86,5	170,3	216,9
1000	1070	80	1000	100	2,04	0,40	93,8	185,2	236,1
1200	1270	80	1200	100	2,30	0,45	108,1	214,0	273,1
1400	1470	80	1400	100	2,60	0,50	120,3	238,5	304,4
1600	1670	80	1600	100	2,90	0,60	132,3	262,6	335,4
1800	1870	80	1800	100	3,20	0,65	143,5	285,7	365,3
2000	2070	80	2000	100	3,50	0,70	154,6	308,6	394,9

dati tecnici completi a pag. 40 / full technical data on p. 40

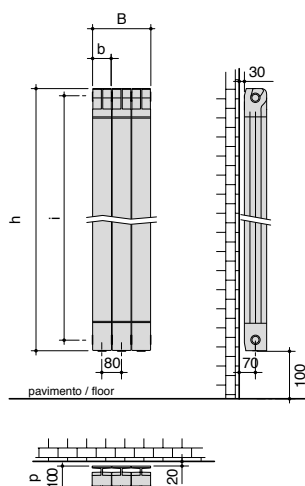

$B = (8 \times N) + 20$ mm
 $N = (\text{max } 6)$ n° elementi batteria
 (max 6) n° elements battery

ACCESSORI / ACCESSORIES



Set Basic valvola e detentore
Basic valve and detentor set



Kit tappi, riduzioni e mensole
Caps, adaptors and brackets kit

accessori completi a pag. 39 / full accessories on p. 39

ALLACCIAMENTI / CONNECTIONS



allacciamenti a pag. 38 / connections on p. 38

Finitura fotografata in queste pagine / Finish photographed on these pages:
 Bismuth - White 9016 Glossy



FINITURE DISPONIBILI / AVAILABLE FINISHES

Standard: RAL BIANCO LUCIDO 9016
 RAL 9016 white glossy

Verniciature RAL / RAL paints



Verniciature materiche
 Textured paints

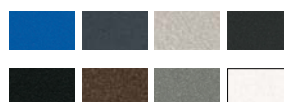

Verniciature speciali
 Special paints



cartella colori completa a pag. 43 / full color chart on p. 43

**Energia
e calore**

*Energy
and warmth*

KALDUS

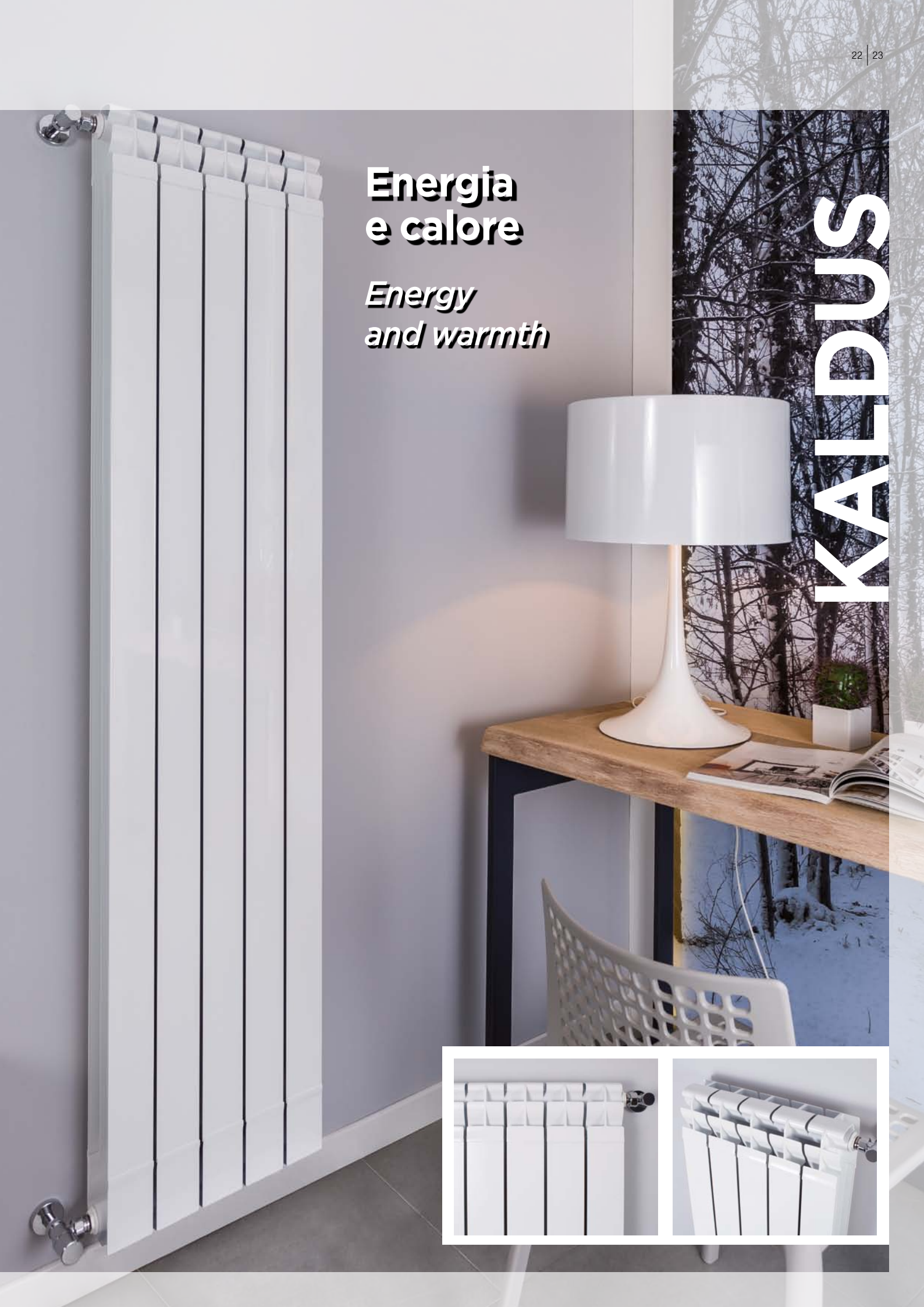
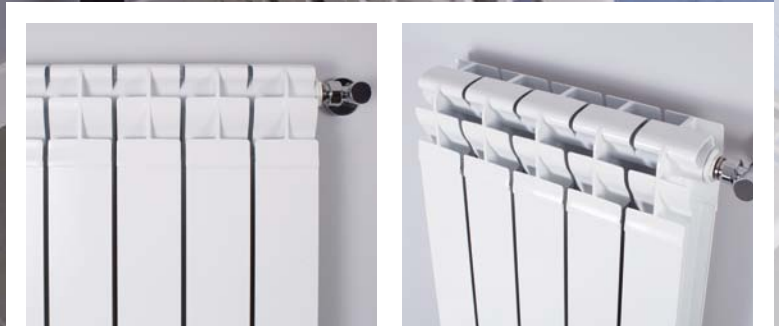

Il modello KALIS è il radiatore in alluminio estruso e pressofuso, il connubio perfetto tra praticità e potenza termica. Adatto per ogni spazio abitativo e per chi cerca un'ottima soluzione salva-spazio.

KALIS is the radiator model in extruded and die-cast aluminium that embodies the perfect combination of functionality and heating power. Suitable for any living space, ideal for those seeking an excellent space-saving solution.

MODELLO <i>model</i>	5 altezza <i>height</i>	b (mm) larghezza <i>width</i>	i (mm) interasse <i>center distance</i>	p (mm) profondità <i>depth</i>	peso <i>weight</i> kg	contenuto d'acqua <i>water content</i> lt	resa termica / <i>thermal output w</i>		
							Δt 30°	Δt 50°	Δt 60°
900	970	80	900	100	1,85	0,37	85,9	169,6	216,2
1000	1070	80	1000	100	2,00	0,38	93,7	184,6	235,2
1200	1270	80	1200	100	2,30	0,40	106,4	211,7	270,6
1400	1470	80	1400	100	2,60	0,50	119,3	237,1	303,0
1600	1670	80	1600	100	2,90	0,60	131,7	261,7	334,4
1800	1870	80	1800	100	3,20	0,65	143,0	284,6	363,8
2000	2070	80	2000	100	3,50	0,70	154,2	307,5	393,4

dati tecnici completi a pag. 40 / full technical data on p. 40

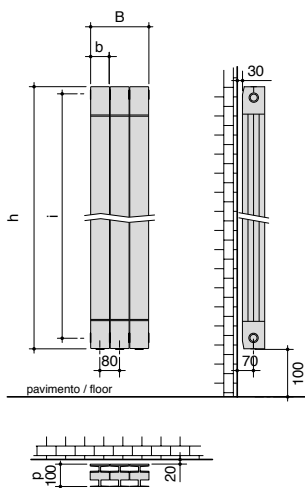

$B = (8 \times N) + 20 \text{ mm}$
 $N = (\text{max } 6) \text{ n}^\circ \text{ elementi batteria}$
(max 6) n° elements battery

ACCESSORI / ACCESSORIES



Set Basic valvola e detentore
Basic valve and detentor set



Kit tappi, riduzioni e mensole
Caps, adaptors and brackets kit

accessori completi a pag. 39 / full accessories on p. 39

ALLACCIAMENTI / CONNECTIONS



allacciamenti a pag. 38 / connections on p. 38

Finitura fotografata in queste pagine / Finish photographed on these pages:
 Noir Sablé 9000 - White 9016 Glossy



FINITURE DISPONIBILI / AVAILABLE FINISHES

Standard: RAL BIANCO LUCIDO 9016
RAL 9016 white glossy

Verniciature RAL / RAL paints



Verniciature materiche
Textured paints

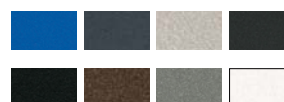

Verniciature speciali
Special paints



cartella colori completa a pag. 43 / full color chart on p. 43



**Praticità e
potenza**

*Functionality
and power*



KALIS



Il modello KALIS BATH è la versione bagno del modello Kalis. Adatto per chi necessita di un radiatore discreto, funzionale e di massima resa.

KALIS BATH is the towel warmer version of the Kalis model. The best choice for those seeking a discreet, functional and highly efficient radiator.

MODELLO model	h (mm) altezza height	b (mm) larghezza width	i (mm) interasse center distance	p (mm) profondità depth	peso weight kg	contenuto d'acqua water content lt	resa termica / thermal output w		
							Δt 30°	Δt 50°	Δt 70°
3.1 MODELLO A TRE ELEMENTI CON 1 BARRA / MODEL 3 ELEMENTS WITH 1 BAR									
900	970	80	900	126	6,1	1,1	257,8	508,8	796,2
1000	1070	80	1000	126	6,5	1,1	281,0	553,8	865,8
1200	1270	80	1200	126	7,5	1,2	319,2	635,1	999,3
1400	1470	80	1400	126	8,3	1,5	357,8	711,3	1118,4
1600	1670	80	1600	126	9,0	1,8	394,9	785,1	1234,0
1800	1870	80	1800	126	10,0	2,0	429,1	853,8	1343,4
2000	2070	80	2000	126	11,0	2,1	462,6	922,5	1453,4
3.2 MODELLO A TRE ELEMENTI CON 2 BARRE / MODEL 3 ELEMENTS WITH 2 BARS									
1600	1670	80	1600	126	9,2	1,8	394,9	785,1	1234,0
1800	1870	80	1800	126	10,2	2,0	429,1	853,8	1343,4
2000	2070	80	2000	126	11,3	2,1	462,6	922,5	1453,4
2.2 MODELLO A DUE ELEMENTI CON 2 BARRE / MODEL 2 ELEMENTS WITH 2 BARS									
1600	1670	80	1600	126	6,5	1,2	263,3	523,4	822,7
1800	1870	80	1800	126	7,1	1,4	286,0	569,2	895,6
2000	2070	80	2000	126	7,7	1,4	308,4	615,0	968,9

dati tecnici completi a pag. 40 / full technical data on p. 40

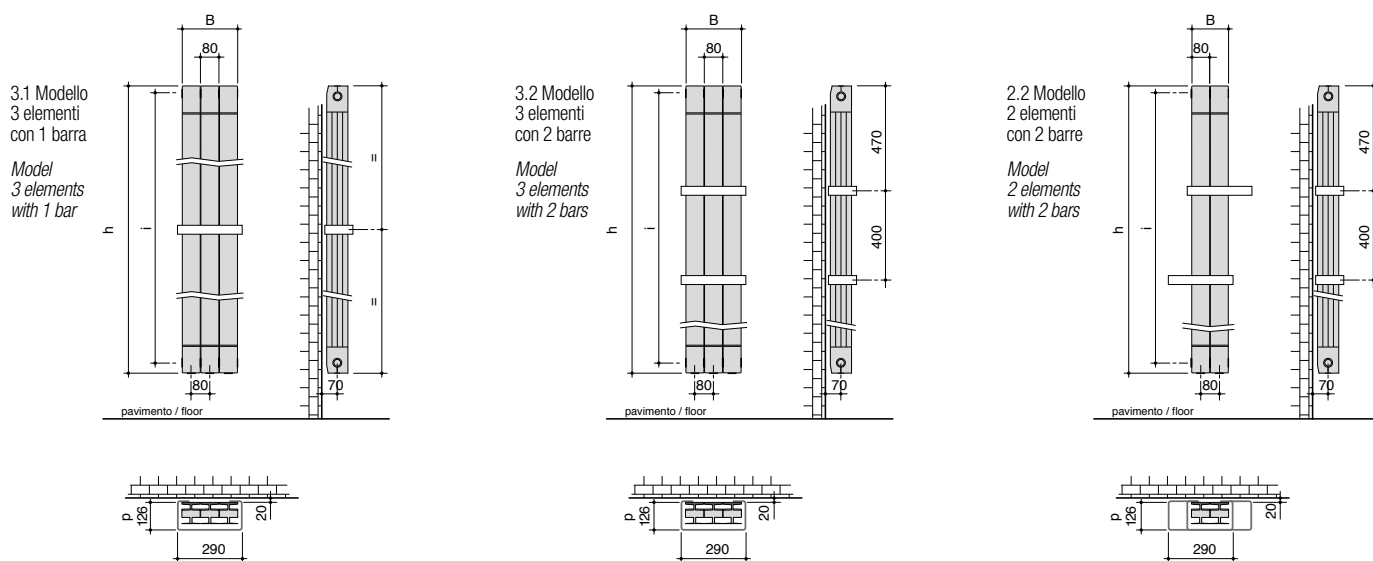

$$B = (8 \times N) + 20 \text{ mm} \quad N = (\text{max } 3) \text{ n}^\circ \text{ elementi batteria} / (\text{max } 3) \text{ n}^\circ \text{ elements battery}$$

FINITURE DISPONIBILI / AVAILABLE FINISHES

Standard: RAL BIANCO LUCIDO 9016
RAL 9016 white glossy

- Verniciature RAL / RAL paints
- Verniciature materiche / Textured paints
- Verniciature speciali / Special paints

cartella colori completa a pag. 43 / full color chart on p. 43

ALLACCIAMENTI / CONNECTIONS



allacciamenti a pag. 38 / connections on p. 38

Finitura fotografata in queste pagine / Finish photographed on these pages:
Bronzo Scuro - White 9016 Glossy

ACCESSORI / ACCESSORIES



Set Basic valvola e detentore
Basic valve and detentor set



Kit tappi, riduzioni e mensole
Caps, adaptors and brackets kit

accessori completi a pag. 39 / full accessories on p. 39

**Rigore e
funzionalità**

*Precision and
functionality*

KALIS BATH

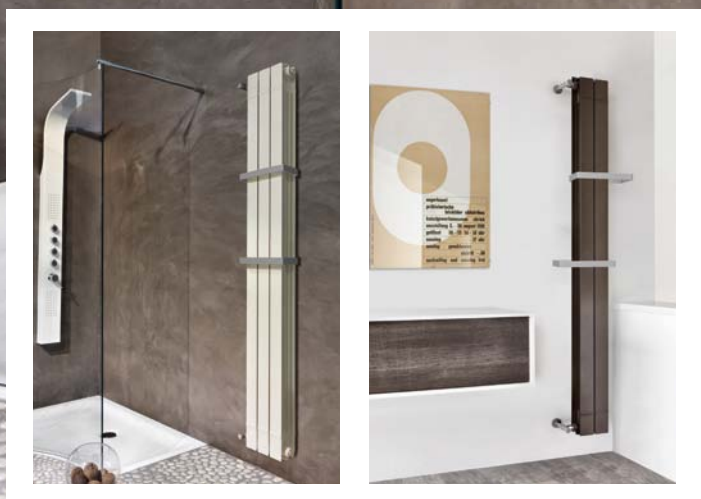

Il COVER è il capostipite di un nuovo concetto di radiatore pressofuso. Esprime un'eleganza senza compromessi, una piacevolezza estetica universale.

COVER introduces a new concept of die-cast radiator. Its uncompromising elegance has a truly universal aesthetic appeal.

MODELLO <i>model</i>	h (mm) altezza <i>height</i>	b (mm) larghezza <i>width</i>	i (mm) interasse <i>center distance</i>	p (mm) profondità <i>depth</i>	peso <i>weight</i> kg	contenuto d'acqua <i>water content</i> lt	resa termica / <i>thermal output w</i>		
							$\Delta t 30^\circ$	$\Delta t 50^\circ$	$\Delta t 70^\circ$
500	650	810	500	100	21,5	4,6	578,0	1133,0	1764,0
600	750	810	500	100	21,5	5,3	693,0	1385,0	2157,0

dati tecnici completi a pag. 40 / *full technical data on p. 40*

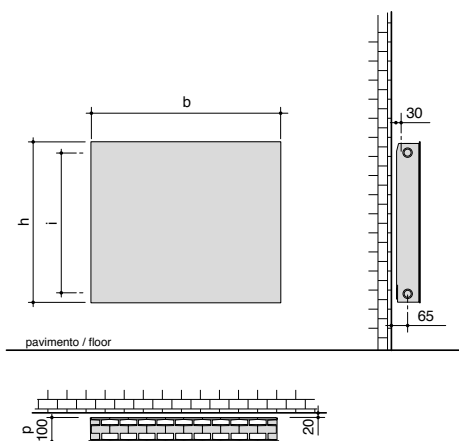

Finitura fotografata in queste pagine / *Finish photographed on these pages: White 9016 Glossy*



ACCESSORI / ACCESSORIES



Set Cromo, raccordo e rosetta
Chrome Set, connector and washer

accessori completi a pag. 39 / *full accessories on p. 39*

FINITURE DISPONIBILI / AVAILABLE FINISHES

- Standard: BIANCO LUCIDO
White glossy
- VERNICIATURE E VETRO TEMPERATO
NERO LUCIDO
Paintwork and glossy black tempered glass
- VERNICIATURE E VETRO TEMPERATO
GRIGIO LUCIDO
Paintwork and glossy grey tempered glass

cartella colori completa a pag. 43 / *full color chart on p. 43*

ALLACCIAMENTI / CONNECTIONS

A **B** **C*** **D***

* con sovrapprezzo
with extra charge

allacciamenti a pag. 38 / *connections on p. 38*

COVER

Minimal chic

Minimal chic



Vulkano è il primo ventil-radiatore interamente in alluminio riciclato.

VULKANO unisce le eccellenze del design made in Italy a concetti tecnici che lo rendono idoneo all'utilizzo in combinazione con i più performanti impianti di produzione termica, siano essi solari termici, caldaie a condensazione o pompe di calore, sia in riscaldamento che in raffrescamento. La sua elettronica intelligente permette di selezionare il livello di comfort termico ambiente per ambiente ed in base a questo gestisce la velocità delle ventole, portandole al livello minimo ed extra silenzioso una volta raggiunto.

VULKANO è dotato della funzione "SLEEP" da utilizzare per escludere il funzionamento della ventilazione nelle ore notturne (a differenza dei ventilconvettore scalda anche a ventilazione spenta) e funzione "BOOST" per massimizzare il rendimento per un tempo limitato ed avere comfort immediato.

Vulkano is the first ventil-radiator to be made entirely from recycled aluminium.

VULKANO combines the excellence of Italian design with cutting-edge technical contents that make it suitable for use in the most advanced thermal production systems, whether using solar panels, condensing boilers or heat pumps, whether for heating or for cooling purposes. Its intelligent electronics make it possible to select a different temperature for each room and once the desired thermal comfort has been reached it adjusts fan speed to the minimum, extra silent level.

VULKANO features a "SLEEP" mode that cuts off the ventilation at night (unlike fan coils, VULKANO keeps radiating heat with the ventilation off) and a "BOOST" mode that maximises efficiency for a limited time to provide immediate comfort.

MODELLO model	h (mm) altezza height	b (mm) larghezza width	i (mm) interasse center distance	p (mm) profondità depth	peso weight kg	cont. d'acqua water content lit	cons. elettrico electric consumption W	alimentazione power supply V/Hz	SLEEP BOOST
500	650	810	500	100	22,5	4,6	14,2	220/50	standard
600	750	810	500	100	26,5	5,3	14,2	220/50	standard

MODELLO model	capacità di raffrescamento (con T ambiente 25°C) cooling capacity (with ambient T = 25°C)			resa termica ¹ / thermal output w		
	resa termica (T H ₂ O 2°C) umidità (W) ² thermal output (TH ₂ O 2°C) humidity (W) ²	resa termica (T H ₂ O 13°C) umidità 20% (W) ³ thermal output (TH ₂ O 13°C) humidity 20% (W) ³	resa termica (T H ₂ O 15°C) umidità 34% (W) ³ thermal output (TH ₂ O 15°C) humidity 34% (W) ³	Δt 30°	Δt 50°	Δt 70°
500	944,0	457,0	373,0	1381,0	2442,0	3557,0
600	1151,0	558,0	455,0	1547,0	2733,0	3974,0

- (1) in funzione tasto BOOST / BOOST mode activated
- (2) aria ambiente da deumidificare / ambient air to be dehumidified
- (3) per valori di umidità superiori prevedere deumidificazione ambiente / for higher humidity values, ambient air dehumidification is required

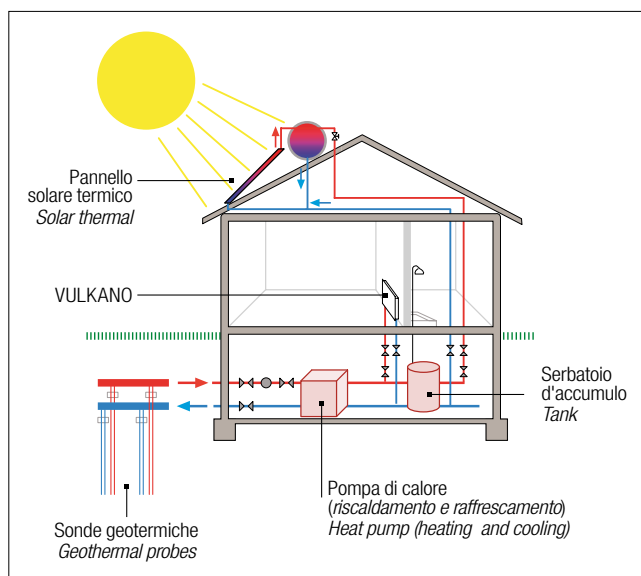
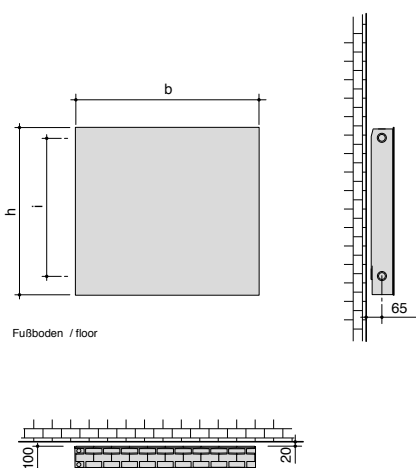

ALLACCIAMENTI / CONNECTIONS

- A** **B** **C*** **D***

* con sovrapprezzo
with extra charge

allacciamenti a pag. 38 / connections on p. 38

Finitura fotografata in queste pagine / Finish photographed on these pages: Black glossy

FINITURE DISPONIBILI / AVAILABLE FINISHES

Standard: BIANCO LUCIDO
White glossy

VERNICIATURE E VETRO TEMPERATO
Paintwork and glossy tempered glass

cartella colori completa a pag. 43 / full color chart on p. 43

Potente, elegante e versatile

*Powerful, elegant
and versatile*

VULKANO



INFORMAZIONI TECNICHE

TECHNICAL INFORMATION

INSTALLAZIONE / INSTALLATION

L'installazione dei radiatori Radiatori 2000 è facile e rapida in quanto vengono forniti in batterie preassemblate e possono essere composti in differenti lunghezze.

Per avere le massime prestazioni di prodotto si consiglia le seguenti modalità di installazione:

- Assicurarsi che il Ph dell'acqua nel circuito sia compreso tra i valori 7-8
- La pressione massima di funzionamento è di 6 bar (tranne che per i modelli russi)
- Temperatura acqua: $T_{in}=75^{\circ}\text{C}$; $T_{out}=65^{\circ}\text{C}$; $T_{media}=70^{\circ}\text{C}$; $T_{max}=90^{\circ}\text{C}$
- Temperatura aria locale di prova: 20°C
- Assicurarsi una distanza minima dalla parete di 3 cm e dal pavimento 12 cm. Nel caso in cui il radiatore sia installato in una nicchia, la distanza dal piano superiore deve essere almeno di 10 cm
- Posizionare le mensole di supporto equidistanti dal baricentro del radiatore e distanziate in base al numero di elementi
- Al fine di preservare gli impianti termici da processi corrosivi o di incrostazione, interessanti radiatori, tubazioni e caldaie, la normativa UNI-CTI 8065 prevede il trattamento delle acque di riempimento degli impianti senza distinzione fra alluminio, acciaio e ghisa. Fra i vari prodotti da additivare all'acqua degli impianti, secondo la citata Norma UNI, vi è una poliammina alifatica filmante in commercio con la denominazione Cillit-HS 23 Combi.
- Il radiatore dovrà essere dotato della valvola di sfiato (si consiglia il tipo automatico)
- Si garantisce la perfetta tenuta degli elementi e degli accessori solo utilizzando le apposite guarnizioni

In oltre per manutenzione si ricorda di non utilizzare prodotti abrasivi e solventi per la pulizia delle superfici.

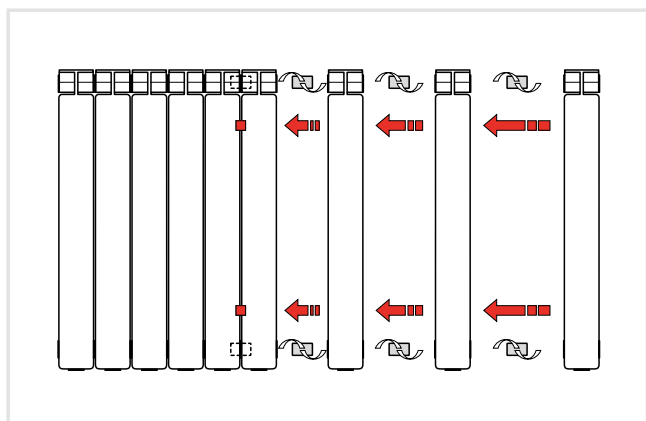

Installing Radiatori 2000 aluminium radiators is quick and easy, made up of individual sections the radiators can be made in different length and then supplied pre-assemble.

In order to obtain the best performances of product we suggest the following ways of installation:

- *The system water's pH must be between 7 and 8*
- *Maximum working pressure is 6 bar (a part for the Russian models)*
- *Water temperature: $T_{in}=75^{\circ}\text{C}$; $T_{out}=65^{\circ}\text{C}$; $T_{media}=70^{\circ}\text{C}$; $T_{max}=90^{\circ}\text{C}$*
- *Testing air room temperature: 20°C*
- *The minimum distance from the radiator to the wall must be 3 cm, the minimum distance from the floor must be 12 cm. if the radiator is installed in a niche, the distance from the upper level must be at least 10 cm*
- *Position the support brackets equidistant from the center of gravity of the radiator and spaced according to the number of elements.*
- *Standard UNI-CTI 8065 requires that the waters used to fill a heating system undergo a prior treatment to protect the heating system from corrosion and encrustation, without making any distinction between aluminium, steel and cast iron. Among the various additives used in the water there is a film-forming aliphatic polyamine-based product called Cillit-HS 23 Combi.*
- *Each radiator must be equipped with an air valve (if possible an automatic one)*
- *The perfect tightness of elements and accessories is guaranteed only using the proper own gaskets.*

In addition to the maintenance do not use abrasive products and solvent to clean the radiator's surfaces.

I radiatori vengono forniti in batterie pre-assemblate mediante il pratico sistema a nipples. È comunque possibile aggiungere o togliere il numero di elementi desiderati ad una batteria. Tale sistema rende i radiatori in alluminio estremamente versatili, con la possibilità di variare sempre il numero di elementi, sia nel caso di eventuali correzioni in fase di realizzazione di nuovi impianti, sia nel caso di modifiche di impianti esistenti.

Radiators are supplied as batteries assembled by means of nipples. With this system it is always possible to add or remove the desired number of elements from a battery. Hence aluminium radiators are extremely versatile and the number of elements assembled together can always be changed, whether to make adjustments when installing a new system or to adapt an existing one.

VERSATILITÀ ED ENERGIA / VERSATILITY AND ENERGY

Utilizzare un impianto con radiatori in alluminio consente di risparmiare sui costi di gestione e può essere utilizzato con qualsiasi ristrutturazioni energetiche, può essere abbinato a caldaie a condensazione, pompe di calore integrati a pannelli solari, sistemi geotermici e utilizzato con acqua a bassa temperatura. **Ideale per ristrutturazioni.**

A heating system that uses aluminium radiators makes for lower operating costs, it can be used with all types of energy generating system - condensing boilers, heat pumps combined with solar panels, geothermal systems -, and it can be used with water at low temperatures. Ideal for renovations.

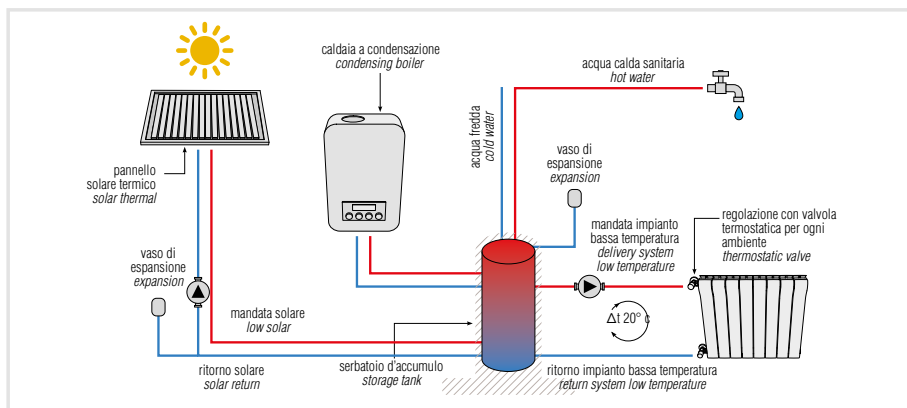

CALDAIA A CONDENSAZIONE ED INTEGRAZIONE SOLARE
Impianto di riscaldamento a bassa temperatura

CONDENSING BOILER AND SOLAR INTEGRATION
Heating system low temperature

POMPA DI CALORE ED INTEGRAZIONE SOLARE
Impianto di riscaldamento a bassa temperatura

HEATING PUMP AND INTEGRATION
Heating system low temperature

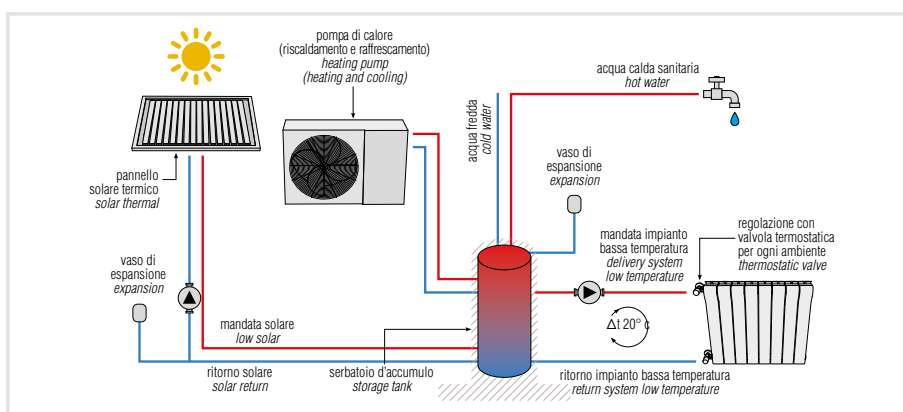

POMPA DI CALORE E CALDAIA A CONDENSAZIONE
Impianto di riscaldamento ibrido a bassa temperatura

HEATING PUMP AND CONDENSING BOILER
Heating system hybrid low temperature

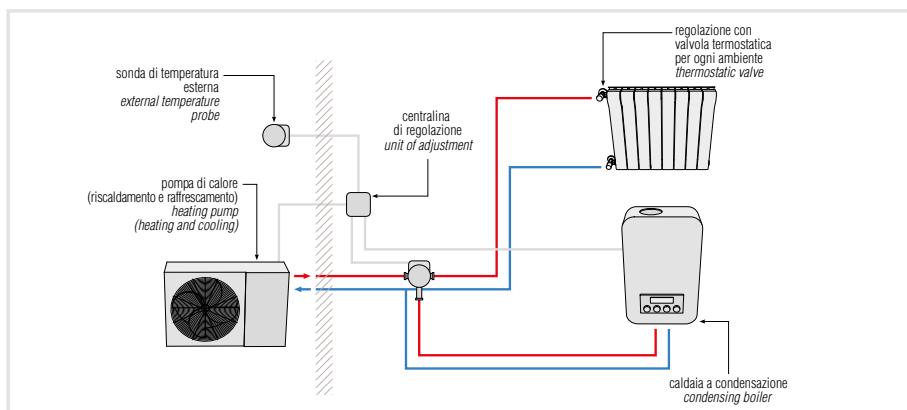

POMPA DI CALORE GEOTERMICA ED INTEGRAZIONE SOLARE
Impianto di riscaldamento a bassa temperatura

GEOTHERMAL HEATING PUMP AND INTEGRATION SOLAR
Heating system low temperature

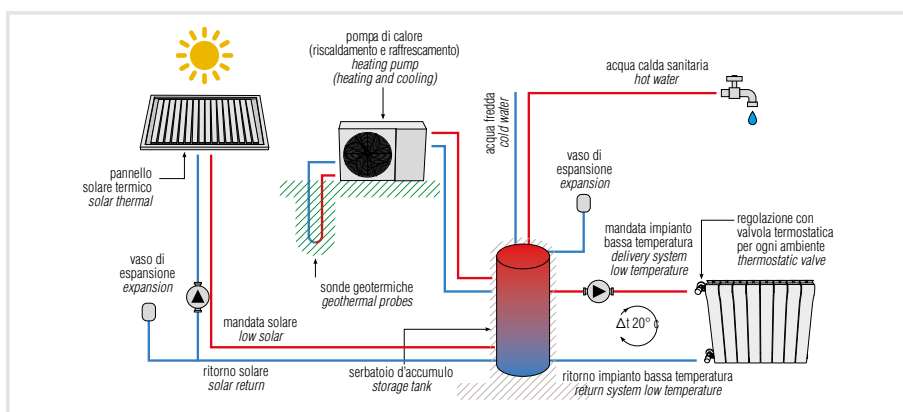

QUALITÀ E CERTIFICAZIONI / QUALITY & CERTIFICATIONS

Radiatori 2000 Spa considera la qualità una priorità da tenere in alta considerazione.

Dalla scelta dei materiali fino all'imballaggio niente è casuale, ma tutto frutto di accurate ricerche per garantire il miglior prodotto sul mercato.

Tutti i nostri processi sono certificati secondo la Norma Europea **UNI EN ISO 9001, UNI EN ISO 14001 e OHSAS 18001** mentre i prodotti sono certificati e conformi alla norma UNI EN 442 dal Politecnico di Milano, realizzati secondo i più avanzati e severi standard di qualità.

Investire nella qualità ha permesso di ottenere diversi brevetti a livello internazionale e diverse certificazioni quali: GOST, DOP, AENOR, NF *

*Per maggiori dettagli sulle certificazioni di ogni prodotto e per maggiori info: visitare www.radiatori2000.it per il marchio NF www.certita.fr e AENOR www.aenor.es

Radiatori 2000 Spa views quality as a top priority consideration.

From material selection to packaging, nothing happens by chance, everything is the result of extensive research conducted to offer the best product on the market.

All our processes are certified according to European standard UNI EN ISO 9001, UNI EN ISO 14001 and OHSAS 18001. Our products are certified for conformity to UNI EN 442 by the Politecnico di Milano, and are manufactured according to the most stringent and advanced quality standards.

*Investing in quality has enabled us to obtain many international patents and certifications, such as GOST, DOP, AENOR, NF **

**For more details on Certify products and for additional info: visit the site www.radiatori2000.it, for NF Mark www.certita.fr and AENOR Mark www.aenor.es*



UNI EN ISO 9001:2015



SISTEMA DI GESTIONE QUALITÀ CERTIFICATO



CERTIQUALITY È MEMBRO DELLA FEDERAZIONE CISQ



(*)



(*)



UNI EN ISO 14001:2015



CERTIFIED ENVIRONMENTAL MANAGEMENT SYSTEM

BS OHSAS 18001:2007



CERTIFIED SAFETY MANAGEMENT SYSTEM



ALLACCIAMENTI / CONNECTIONS

A ALLACCIAMENTO CONTRAPPOSTO
opposite ends connection

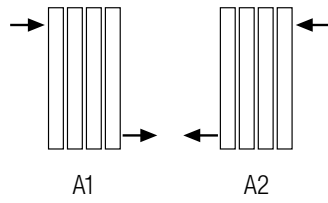

B ALLACCIAMENTO LATERALE
side connection

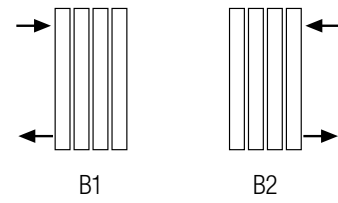

C ALLACCIAMENTO DAL BASSO CON DIAFRAMMA
bottom connection with diverter

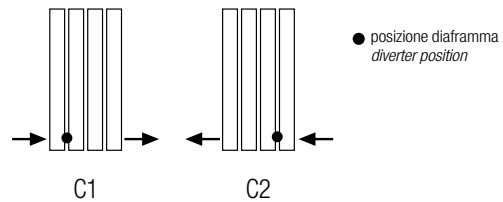

D ALLACCIAMENTO MONOTUBO
single-pipe connection

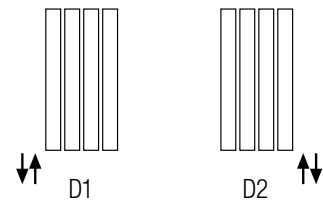

ACCESSORI / ACCESSORIES



SET BASIC valvola termostattizzabile e detentore a squadra con attacco per tubo rame, multistrato o ferro, finitura nickel con manopola in plastica cromata, nera o bianca.

Thermostat compatible valve kit and right-angle lockshield, with connection for copper, multilayer or iron pipes, nickel finish with choice of chromed, black or white plastic handle.



SET CROMO valvola termostattizzabile e detentore a squadra con attacco per tubo rame, multistrato o ferro, finitura nickel con manopola in plastica cromata, nera o bianca.

Thermostat compatible valve kit and right-angle lockshield, with connection for copper, multilayer or iron pipes, chrome finish with choice of chromed, black or white plastic handle.



Kit valvola termostattizzabile combinata destra e detentore combinato sinistro con attacco per tubo rame, multistrato o ferro, multistrato o ferro, finitura cromo.

Combined right thermostat compatible valve kit and combined left lockshield, with connection for copper, multilayer or iron pipes, chrome finish.



Gruppo valvola termostattizzabile/detentore cromato, interasse 50mm, compatibile con raccordi per tubi rame, multistrato e ferro, per impianti mono-tubo e bitubo.

Valve/lockshield assembly suitable for thermostat control, chromed, 50 mm spaced connections, for copper, multilayer or iron pipes, for double pipe plants.



Kit di tappi e riduzioni (dx-sx) da 1" Verniciati RAL 9016 con mensola a murare.

Kit of Plugs and reductions (right & left) 1" Gas RAL 9016 with standard wall brackets.



Kit di tappi e riduzioni (dx-sx) da 1" Verniciati RAL 9016.

Kit of Plugs and reductions (right & left) 1" Gas RAL 9016



Tappi e riduzioni (dx-sx) da 1" Verniciati RAL 9016.

Plugs and reductions (right & left) 1" Gas RAL 9016.



Guarnizione per tappi e nipples.

Ecological gaskets for plugs and nipples.



Bomboletta vernice spray RAL 9016 - 400 ml.

Spray bombs RAL 9016 400 ml.



Nipples 1".

Nipples 1".



Mensola a tassello.

Adjustable wall brackets.

Supporto a terra per Kalis, Kaldus, Plus, Kaldo, Best e Helyos, finitura bianco.

Free-standing base for Kalis, Kaldus, Plus, Kaldo, Best and Helyos, white finish.



RESE TERMICHE / THERMAL OUTPUT

Tutte le rese termiche che appaiono in questo catalogo sono **certificate e conformi alla norma EN 442** dal Politecnico di Milano, in base alla quale la potenza termica nominale dei radiatori è determinata in camera di prova con $\Delta T=50^\circ$ e in cui viene anche stabilito il **coefficiente n** che permette di calcolare le varie potenze termiche, anche quelle a bassa temperatura.

RESA TERMICA CON T DIVERSO DA 50°

Molto spesso si desidera sapere la resa termica del radiatore con una temperatura dell'acqua della caldaia differente da quella indicata a catalogo.

Più che di temperatura dell'acqua si parla di ΔT (differenza di temperatura) tra la temperatura media dell'acqua e la temperatura dell'ambiente da scaldare.

Normalmente si parla di $\Delta T50^\circ\text{C}$, cioè si considera la temperatura media dell'acqua pari a 70°C (acqua prodotta dalla caldaia a 75°C e ritorno alla caldaia dopo essere passata dal radiatore 65°C con media pari a 70°C) con ambiente a 20°C ($70-20=50$ da cui $\Delta T50^\circ\text{C}$).

Se si dovesse avere la temperatura dell'acqua superiore o inferiore rispetto ai 75°C , in fase di omologazione del radiatore viene definito anche un coefficiente (coefficiente "n" noto al fabbricante) che permette di **ricalcolare la resa termica secondo la seguente formula:**

Resa diversa da $\Delta T 50^\circ\text{C} =$

$$\text{resa a } \Delta T50^\circ\text{C} \times (\text{nuovo } \Delta T / 50)^n$$

Ad esempio, per il modello Helyos 600 a $\Delta T=30^\circ$
 $\Delta T30^\circ = 139,9 \times (30/50)^{1,3}$
per semplicità si può considerare $n=1,3$

Nella pagina seguente valori di potenze termiche con ΔT diverso da 50°C e relativi coefficienti "n" per modello di radiatore.

All the thermal yield values mentioned in this catalogue are certified by the Politecnico di Milano for conformity to standard EN 442, with which the rated thermal power of a radiator is determined in a testing chamber with $\Delta T=50^\circ$, where the n coefficient that makes it possible to calculate the various thermal power levels, even at low temperatures, is also established.

THERMAL YIELD WITH ΔT OTHER THAN 50°

In many instances we want to ascertain the thermal yield of a radiator with a boiler water temperature other than the one specified in the catalogue. Rather than speaking of the temperature of the water, we speak of the ΔT (difference in temperature) between the average temperature of the water and the temperature of the room to be heated.

Normally, the term of reference used is $\Delta T50^\circ\text{C}$, i.e., the average temperature of the water is assumed to be 70°C (water produced by the boiler at 75°C and returned to the boiler after passing through the radiator at 65°C , with an average value of 70°C) with an ambient temperature of 20°C ($70-20=50$, hence $\Delta T50^\circ\text{C}$).

If the temperature of the water is higher or lower than 75°C , at the radiator homologation stage an ad hoc coefficient is determined (the "n" coefficient known to the manufacturer) which makes it possible to calculate the thermal yield of the product according to the following formula:

Thermal yield other than $\Delta T 50^\circ\text{C} =$

$$\text{yield at } \Delta T50^\circ\text{C} \times (\text{new } \Delta T / 50)^n$$

*For example, for model Helyos 600 at $\Delta T=30^\circ$
 $\Delta T30^\circ = 139,9 \times (30/50)^{1,3}$
For the sake of simplicity, it may be assumed to be $n=1,3$*

On the following page thermal power values with ΔT other than 50°C and "n" coefficient by radiator model.

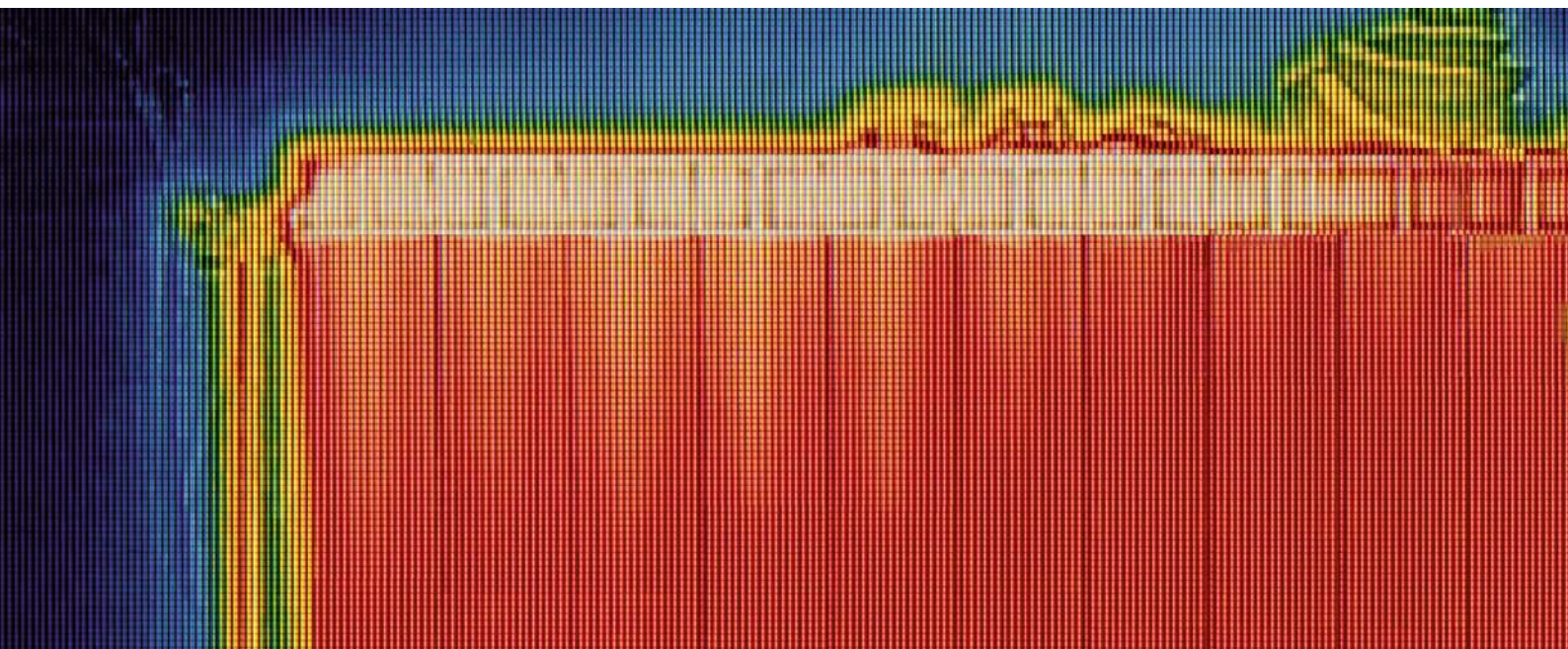

* rese termiche versione alluminio lucidato -9% / *thermal output for polished aluminium radiator version -9%*

		Δt 20°	Δt 25°	Δt 30°	Δt 35°	Δt 40°	Δt 45°	Δt 50°	Δt 60°	Δt 70°	n
OTTIMO	500	32,4	43,0	54,1	65,7	77,8	90,3	103,2	129,9	157,9	1,264
	600	37,1	49,2	62,1	75,5	89,4	103,8	118,6	149,4	181,7	1,268
	800	45,3	60,6	76,8	93,8	111,6	130,1	149,2	189,1	231,1	1,301
HELYOS EVO	350	27,5	36,6	46,2	56,2	66,7	77,6	88,8	112,1	112,1	1,278
	500	38,0	50,4	63,5	77,2	91,4	106,0	121,2	152,6	152,6	1,264
	600	40,7	54,3	68,7	83,9	99,7	116,1	133,1	168,4	168,4	1,293
	700	44,8	60,0	76,1	93,0	110,7	129,1	148,1	187,8	187,8	1,303
	800	49,1	66,0	83,9	102,8	122,7	143,3	164,7	209,4	209,4	1,319
PLUS EVO	350	26,9	35,8	45,1	54,9	65,0	75,5	86,4	108,9	132,4	1,27
	500	35,5	47,3	59,8	72,9	86,6	100,7	115,4	145,9	177,8	1,286
	600	39,1	52,2	66,2	80,8	96,0	111,8	128,2	162,3	198,1	1,294
	700	43,9	58,6	74,2	90,6	107,7	125,5	143,9	182,2	222,4	1,295
	800	48,5	65,0	82,5	100,9	120,1	140,2	160,9	204,1	249,7	1,307
KALDO	350	27,1	36,1	45,7	55,7	66,1	76,9	88,0	111,2	135,6	1,284
	500	35,9	48,1	61,0	74,6	88,7	103,5	118,7	150,6	184,1	1,304
	600	41,3	55,4	70,4	86,2	102,8	120,0	137,8	175,1	214,6	1,314
	700	46,2	61,9	78,6	96,2	114,6	133,7	153,5	194,9	238,6	1,311
	800	50,9	68,5	87,2	106,9	127,6	149,2	171,5	218,4	267,8	1,325
OTTIMO+	900	50,9	68,1	86,4	105,6	125,7	146,5	168,1	213,1	260,5	1,302
	1000	54,9	73,5	93,3	114,1	135,9	158,5	182,0	230,9	282,5	1,307
	1200	62,5	83,9	106,7	130,7	155,8	182,0	209,1	265,8	325,6	1,317
	1400	70,3	94,4	120,1	147,1	175,4	204,9	235,5	299,4	366,9	1,318
	1600	78,0	104,7	133,2	163,2	194,9	227,3	261,3	332,3	407,2	1,319
	1800	85,3	114,5	145,8	178,7	213,3	249,2	286,5	364,5	446,9	1,322
	2000	92,4	124,2	158,2	194,0	231,6	270,7	311,3	396,3	486,1	1,325
KALDUS	900	50,5	67,9	86,5	106,1	126,7	148,1	170,3	216,9	266,2	1,327
	1000	54,6	73,6	93,8	115,2	137,6	161,0	185,2	236,1	289,9	1,332
	1200	62,9	84,7	108,1	132,8	158,8	185,9	214,0	273,1	335,6	1,337
	1400	69,9	94,3	120,3	147,9	176,9	207,1	238,5	304,4	374,2	1,339
	1600	76,8	103,6	132,3	162,7	194,6	228,0	262,6	335,4	412,5	1,342
	1800	83,1	112,2	143,5	176,6	211,5	247,9	285,7	365,3	449,7	1,348
	2000	89,3	120,8	154,6	190,5	228,2	267,6	308,6	394,9	486,5	1,353
KALIS e KALIS BATH	900	50,1	67,4	85,9	105,5	126,0	147,4	169,6	216,2	265,4	1,331
	1000	54,7	73,5	93,7	115,0	137,3	160,5	184,6	235,2	288,6	1,328
	1200	61,6	83,2	106,4	130,9	157,1	183,7	211,7	270,6	333,1	1,347
	1400	69,1	93,3	119,3	146,8	175,6	205,8	237,1	303,0	372,8	1,345
	1600	76,4	103,1	131,7	162,0	193,9	227,1	261,7	334,4	411,3	1,344
	1800	82,8	111,9	143,0	176,0	210,7	246,9	284,6	363,8	447,8	1,347
	2000	89,2	120,5	154,2	189,9	227,5	266,7	307,5	393,4	484,5	1,351

PRESSIONI DI ESERCIZIO PER MODELLO/*operating pressures according to models:*

Helyos Evo - Plus Evo: 20 bar

Ottimo - Classic-al-bath: 16 bar



























Kaldo - Ottimo+ - Kaldus - Kalis - Kalis Bath - Cover - Vulcano: 6 bar

* rese termiche versione alluminio lucidato -9%/*thermal output for polished aluminium radiator version -9%*

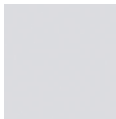



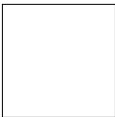

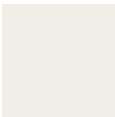
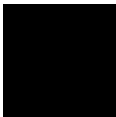
** per versione idronica e ibrida/*for hydronic and hybrid versions*

FINITURE DISPONIBILI / AVAILABLE FINISHES

Verniciature RAL / RAL paints

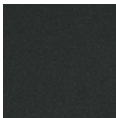
							
RAL 1018 Giallo zinco	RAL1003 Giallo segnale	RAL 2000 Arancio giallo	RAL 2004 Arancio puro	RAL 3000 Rosso fuoco	RAL 3003 Rosso rubino	RAL 3004 Rosso porpora	RAL 3014 Rosa antico
							
RAL 4003 Viola erika	RAL4006 Porpora	RAL 4008 Viola segnale	RAL 4001 Rosso lilla	RAL 4004 Viola bordeaux	RAL 8016 Marrone mogano	RAL 6018 Verde giallo	RAL 6001 Verde smeraldo
							
RAL 5012 Blu chiaro	RAL5015 Blu cielo	RAL 5010 Blu genziana	RAL 7008 Grigio kaki	RAL 7035 Grigio luce	RAL 7005 Grigio topo	RAL 7025 Grigio perla	RAL 7024 Grigio grafite
							
RAL 9016 Bianco traffico	RAL 9010 Bianco puro	RAL 1013 Bianco perla	RAL 9005 Nero profondo				

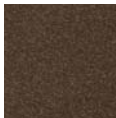
Verniciature materiche / Textured paints

							
SW 327F Blu 500 sablé	YW 357F Violet 2100 sablé	33345 Beige sablé	SW 306F Noir 200 sablé	SN 351F Noir 900 sablé	44810 Bronzo scuro	MX 302L Bismuth	RAL 9010 Bianco puro sablé

Verniciature speciali / Special paints

				
MW136E Gold	SW205F Bronze	SW208F Marron d'Inde	SAP10020 Champagnafrosty	SAP13931 Silver satin

Alluminio anodizzato lucidato Anodized polished aluminium



COVER - VULKANO

Verniciature e vetro temperato Paintwork and tempered glass



Bianco Lucido
White glossy



Nero Lucido
Black glossy



Grigio Lucido
Grey glossy

CREDITS

Graphic design: Forlani Studio

Photo: Marco Nava - Melting Studio

Location: BF Interni - Treviglio

© Radiatori 2000

C-R2000 REV.08 02/2019

Radiatori 2000 Spa

Via Francesca, 54/A
24040 Ciserano (BG) Italy
Phone +39 035 4810174
Fax + 39 035 4821852

radiatori@radiatori2000.it
www.radiatori2000.it

